

Second Edition 2015

DENTAL NOVELTIES



M. A. ARAIN & BROTHERS (PVT.) LTD.
Taking the pain out of medical procurements



**It is Just Small Collection of our Products.
Please Ask for Complete Range**

ARRAIN

New

Stainless Steel Tissue Punches New Tip Design



- 3 mm
32-150-00
- 4 mm
32-151-00
- 5 mm
32-152-00
- 6 mm
32-153-00

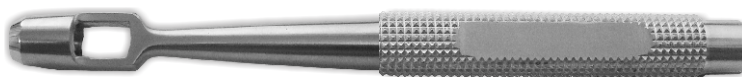

Tissue Punches

- 3 mm
32-155-00
- 4 mm
32-156-00
- 5 mm
32-157-00
- 6 mm
32-158-00



Tissue Punches

- 2 mm
32-160-00
- 3.5 mm
32-163-00
- 2.5 mm
32-161-00
- 4 mm
32-164-00
- 3 mm
32-162-00
- 3.5 mm
32-165-00



Tissue Punches
Set of 6 Tips
32-159-00

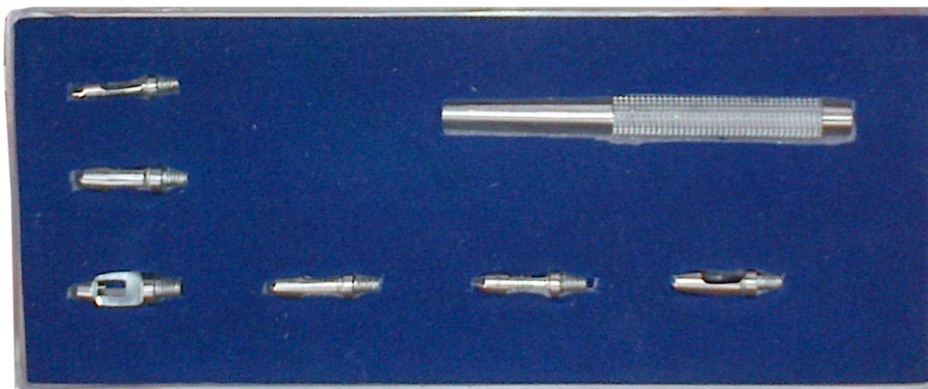

Tissue Punches
Set of 6 Tips

New

Short Trephine Drills & Reversible Ratchet



• For Bone Harvesting

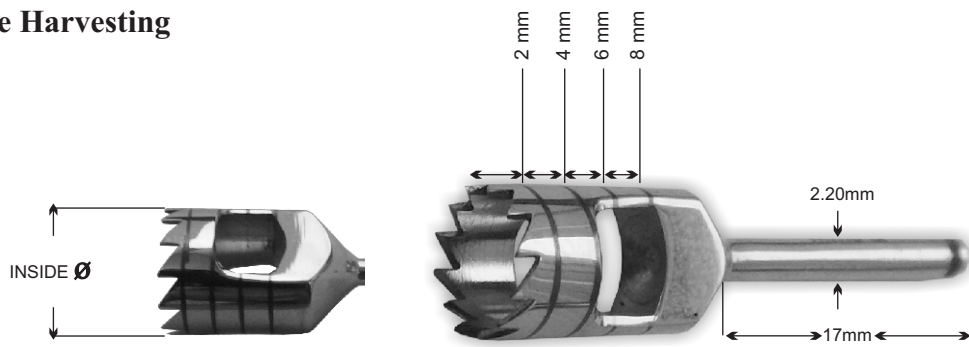

Trephine Drills

 2 mm 32-170-00	 4 mm 32-174-00	 6 mm 32-178-00	 8 mm 32-182-00	 10 mm 32-186-00
 2.5 mm 32-171-00	 4.5 mm 32-175-00	 6.5 mm 32-179-00	 8.5 mm 32-183-00	
 3 mm 32-172-00	 5 mm 32-176-00	 7 mm 32-180-00	 9 mm 32-184-00	
 3.5 mm 32-173-00	 5.5 mm 32-177-00	 7.5 mm 32-181-00	 9.5 mm 32-185-00	

• Torque Wrench For Final Seating



Reversible Ratchet
32-192-00

New

Colour Coded Gracey Curette



Special Handle Gracey Curette

32-201-00	Gracey Curette 1/2
32-203-00	Gracey Curette 3/4
32-205-00	Gracey Curette 5/6
32-207-00	Gracey Curette 7/8
32-209-00	Gracey Curette 9/10
32-211-00	Gracey Curette 11/12
32-213-00	Gracey Curette 13/14
	Available in different colours



Gracey Curette Colour Code

32-215-00	Gracey Curette 1/2
32-217-00	Gracey Curette 3/4
32-219-00	Gracey Curette 5/6
32-221-00	Gracey Curette 7/8
32-223-00	Gracey Curette 9/10
32-225-00	Gracey Curette 11/12
32-227-00	Gracey Curette 13/14
	Available in different colours



Gracey Curette Colour Code

32-229-00	Gracey Curette 1/2
32-231-00	Gracey Curette 3/4
32-233-00	Gracey Curette 5/6
32-235-00	Gracey Curette 7/8
32-237-00	Gracey Curette 9/10
32-239-00	Gracey Curette 11/12
32-241-00	Gracey Curette 13/14
	Available in different colours

New

Gracey Curette

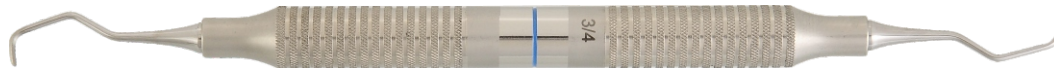

Special Handle Gracey Curette

32-243-00	Gracey Curette 1/2
32-245-00	Gracey Curette 3/4
32-247-00	Gracey Curette 5/6
32-249-00	Gracey Curette 7/8
32-251-00	Gracey Curette 9/10
32-253-00	Gracey Curette 11/12
32-255-00	Gracey Curette 13/14

Available in different colours



Special Handle Gracey Curette

32-257-00	Gracey Curette 1/2
32-259-00	Gracey Curette 3/4
32-261-00	Gracey Curette 5/6
32-263-00	Gracey Curette 7/8
32-265-00	Gracey Curette 9/10
32-267-00	Gracey Curette 11/12
32-269-00	Gracey Curette 13/14



Special Handle Gracey Curette

32-258-00	Gracey Curette 1/2
32-260-00	Gracey Curette 3/4
32-262-00	Gracey Curette 5/6
32-264-00	Gracey Curette 7/8
32-266-00	Gracey Curette 9/10
32-268-00	Gracey Curette 11/12
32-270-00	Gracey Curette 13/14

New

Gracey Curette



Special Handle Gracey Curette
32-401-00 Gracey Curette -1/2



Special Handle Gracey Curette
32-403-00 Gracey Curette -3/4



Special Handle Gracey Curette
32-405-00 Gracey Curette -5/6



Special Handle Gracey Curette
32-407-00 Gracey Curette -7/8



Special Handle Gracey Curette
32-409-00 Gracey Curette -9/10



Special Handle Gracey Curette
32-411-00 Gracey Curette -11/12



Special Handle Gracey Curette
32-413-00 Gracey Curette -13/14

New

Colour Coded Probes



CP-10
32-361-00



CP-11
32-363-00



CP-10
32-365-00



CP-12
32-367-00



CP-Williams
32-369-00



CP-18
32-371-00

New

Colour Coded Probes



Exp-23/CP-Williams
32-373-00



Exp-23/CP-10
32-375-00



Exp-23/CP-2
32-377-00



Exp-23/CP-UNC-15
32-379-00



Exp-23/CP-2
32-381-00



Exp-23/CP-11
32-383-00

New

Colour Coded Probes



Exp-23/CP-2
32-415-00



Exp-23/CP-10
32-417-00



Exp-23/CP-11
32-419-00



Exp-23/CP-11.5.B
32-421-00



Exp-23/CP-12
32-423-00

New

Colour Coded Probes



Exp-23/CP-12.5
32-425-00



Exp-23/CP-15
32-427-00



Exp-23/CP-18
32-429-00



Exp-23/CP-QW
32-431-00



Exp-23/MICHIGON
32-433-00

New

Colour Coded Probes



Exp-23/CP-10
32-435-00



Exp-23/CP-11
32-437-00



Exp-23/CP-12
32-439-00



Exp-23/CP-UNC,15
32-441-00



Exp-23/CP-18
32-443-00



Exp-23/CP-QW
32-445-00

New

Colour Coded Osteotomos



Osteotomos-2mm(5.5-11-13-15-17.5)
32-385-00



Osteotomos-2mm(5.5-11-13-15-17.5)
32-387-00



Osteotomos-3mm(5.5-11-13-15-17.5)
32-389-00



Osteotomos-3.2mm(5.5-11-13-15-17.5)
32-391-00



Osteotomos-3.3mm(5.5-11-13-15-17.5)
32-393-00



Osteotomos-4.1mm(5.5-11-13-15-17.5)
32-395-00



Osteotomos-4.1mm(5.5-11-13-15-17.5)
32-397-00



Osteotomos-5mm(5.5-11-13-15-17.5)
32-399-00

New

Curettes



Max GRIP curettes

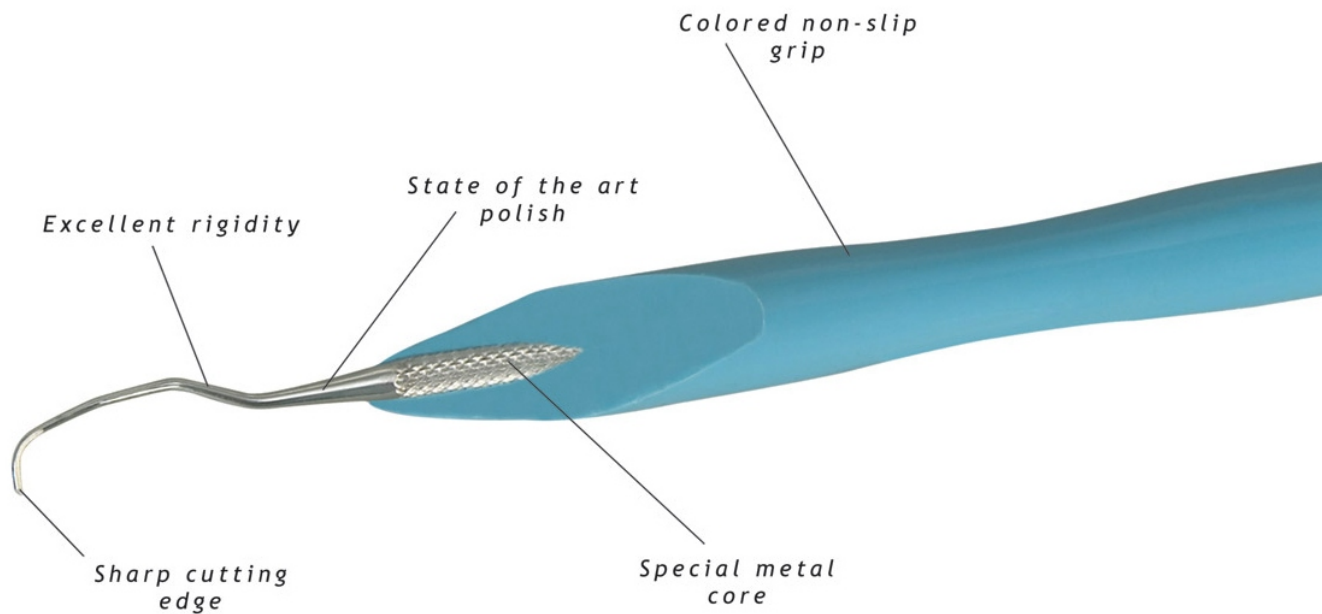

Overall light structure

Max Grip Instruments can be Sterilized / autoclaved upto 200°C
All other type of periodontal Curettes & hand instruments Including explorers, filling Instruments etc. are available In Max Grip handles.



New

Curettes



Max
GRIP
curettes

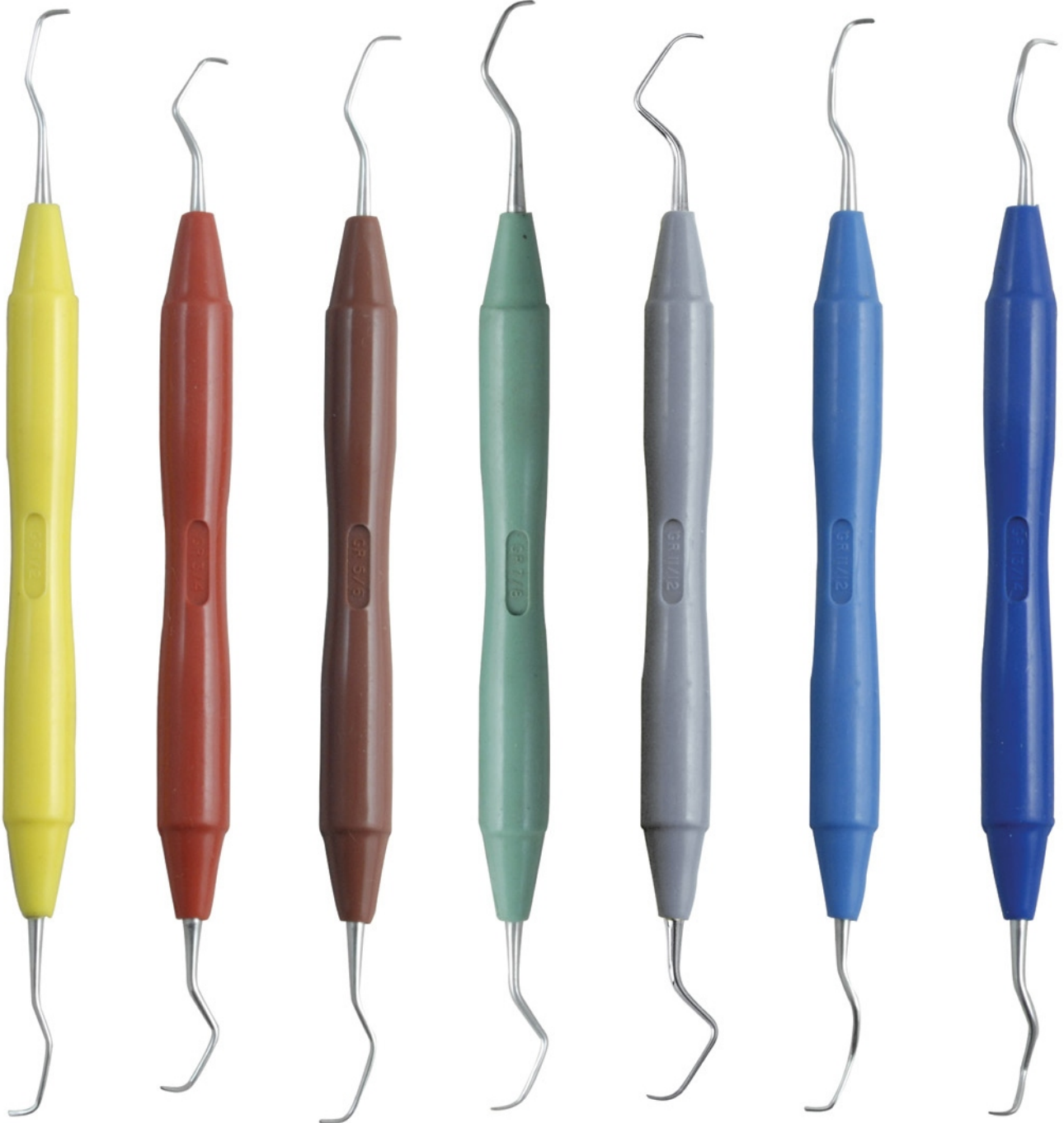

1/2
Gracey
06-075-00

3/4
Gracey
06-076-00

5/6
Gracey
06-077-00

7/8
Gracey
06-078-00

9/10
Gracey
06-079-00

11/12
Gracey
06-080-00

13/14
Gracey
06-081-00

New

Luxators



secure
EXTRACT



secure
EXTRACT

*Give you the confidence,
you have been searching for.*

**Non-Slip
&
Maximum Grip**

New

Luxators



- * Strong & Secure Grip
- * Sterilizable /autoclavable
- * Precise working points
- * No risk of leakage , rust & corrosion
- * Minimum risk of tissue damage & bleeding

secure
EXTRACT

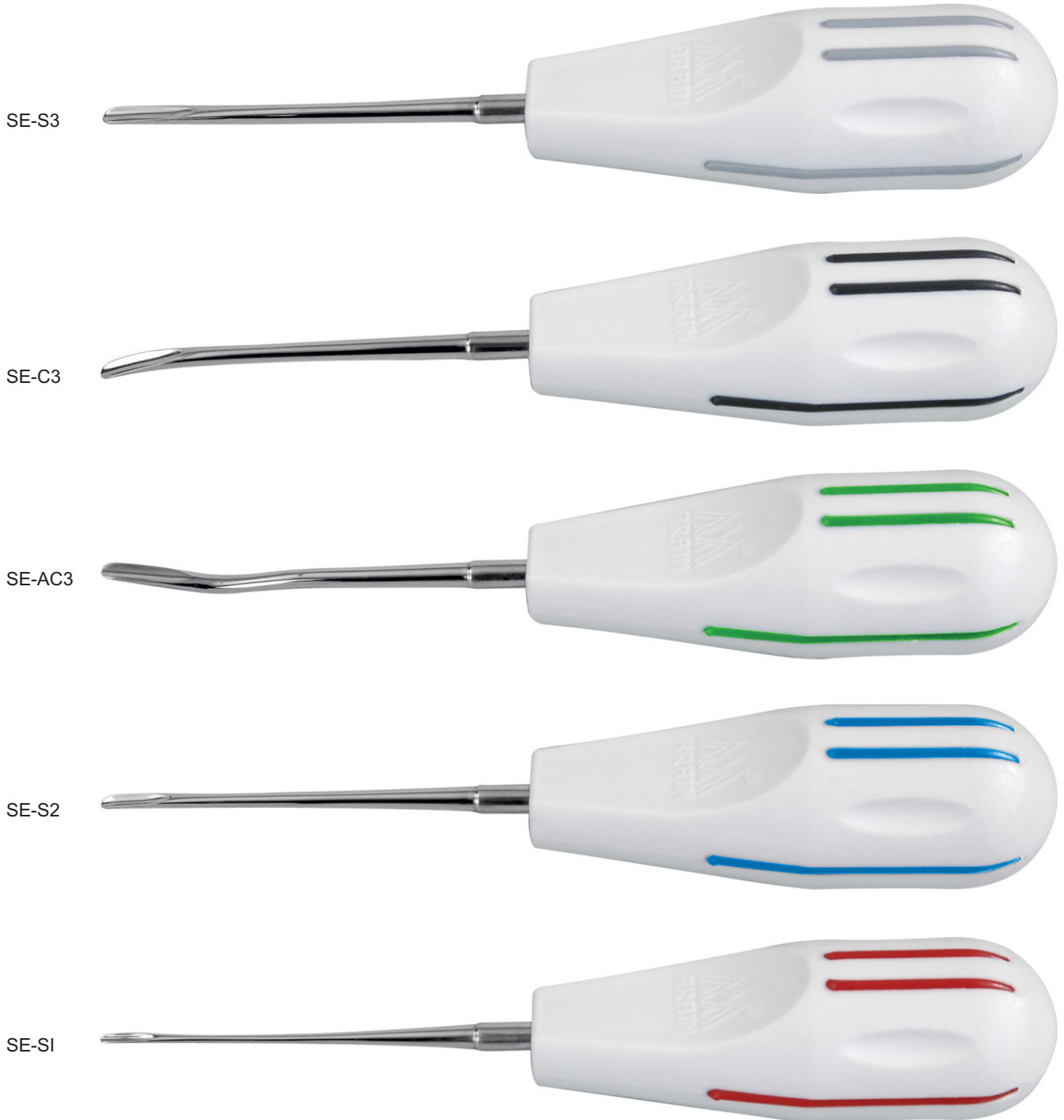

All types of elevators are available with **Secure Extract** handle

New

Implantology Instruments



32-447-00



Molt
32-449-00



Bone Scrapex Straight
32-451-00



Bone Scrapex Bayonet Type
32-453-00

New

Implantology Instruments



Osteotomes(2.0mm)
32-455-00



Osteotomes(3.0mm)
32-457-00



Osteotomes(4.0mm)
32-459-00



Osteotomes(5.0mm)
32-460-00

New

Implantology Instruments



Osteotomes(2.0mm)
32-461-00



Osteotomes(3.0mm)
32-463-00



Osteotomes(3.5mm)
32-465-00



Osteotomes(4.0mm)
32-467-00

New

Implantology Instruments



Graft Material Packers
32-275-00



Bone Collector with Collection Filter
32-271-00

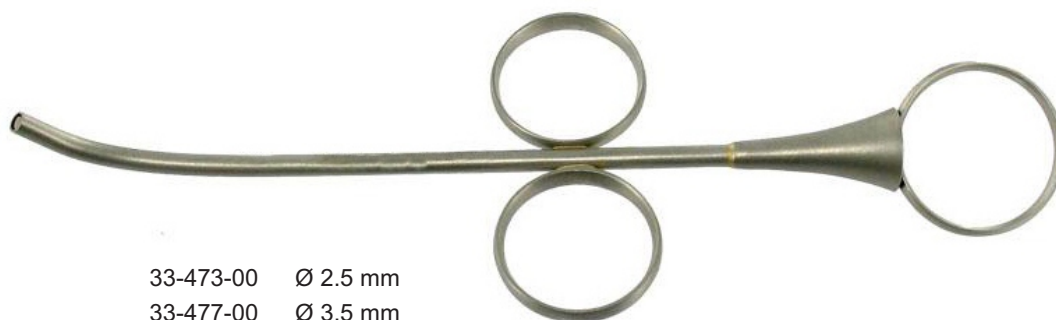

- 33-473-00 Ø 2.5 mm
- 33-477-00 Ø 3.5 mm
- 33-481-00 Ø 4.5 mm
- 33-485-00 Ø 6.5 mm

Bone Carrier



Graft Material Spoon
32-277-00



Buser Micro Raspatory
33-385-00



Ligature Director
31-174-00

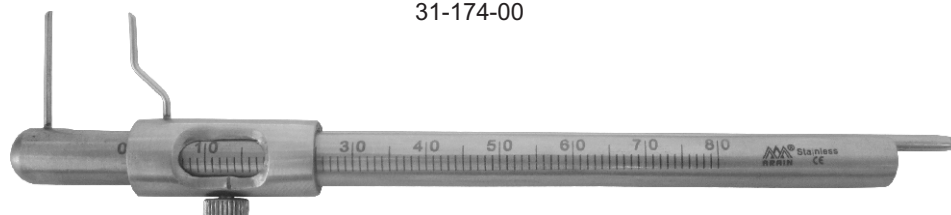

Mini Dental Caliper
32-279-00

New

Orthodontic Pliers



Light Wire Plier
32-283-00



Utility Plier
(Weingart Style Slim Tip)
32-285-00



Weingart Utility Plier
32-287-00



Bird Beak Plier
32-281-00



Adams Plier
32-289-00



Nance Loop Forming Plier
32-291-00



32-293-00



Stop (v-Bend) Plier
32-295-00

New

Lvory, Elliot, Cliper, Rubber Dam Clamp

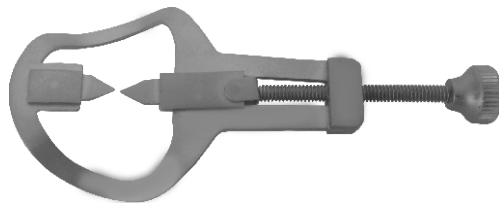

Lvory
32-297-00



Elliot
32-299-00



Castroviejo
32-301-00

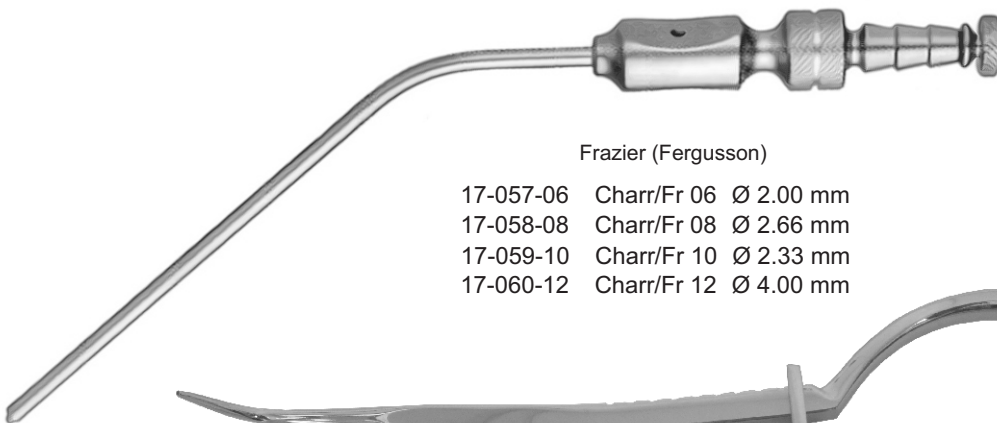

Frazier (Fergusson)

- 17-057-06 Charr/Fr 06 Ø 2.00 mm
- 17-058-08 Charr/Fr 08 Ø 2.66 mm
- 17-059-10 Charr/Fr 10 Ø 2.33 mm
- 17-060-12 Charr/Fr 12 Ø 4.00 mm

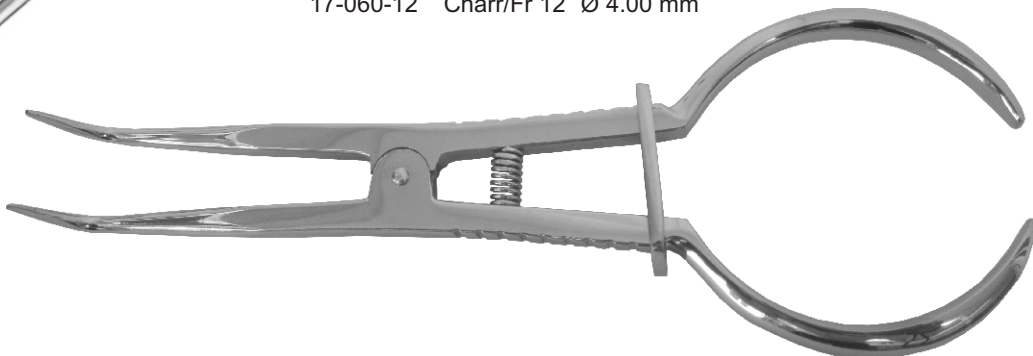

Rubber Dam Clamp Forcep
32-303-00

New

Maxillofacial Instruments

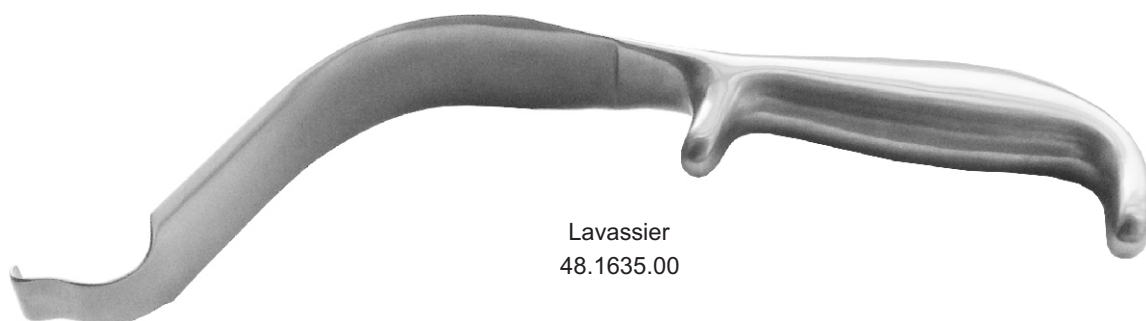

Lavassier
48.1635.00

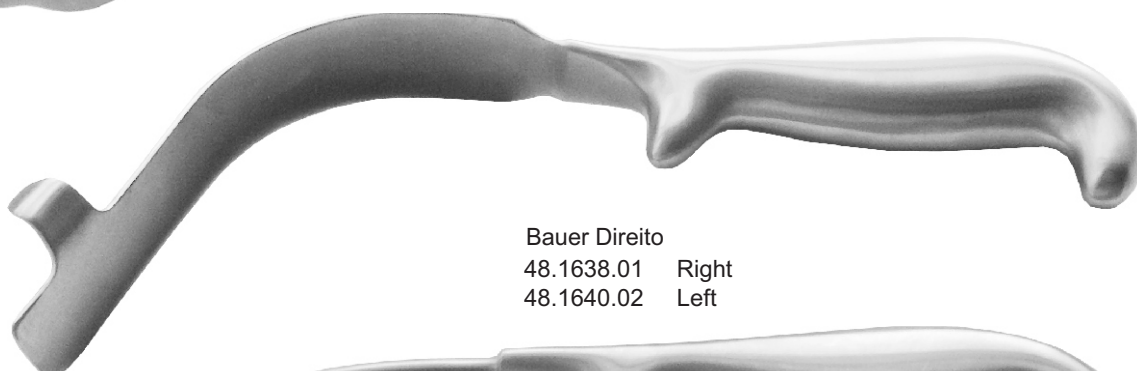

Bauer Direito
48.1638.01 Right
48.1640.02 Left

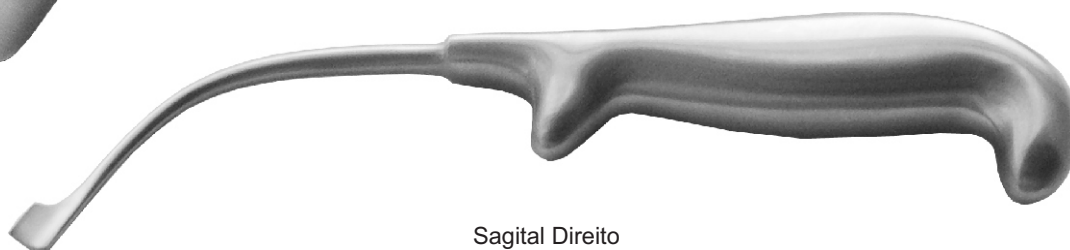

Sagital Direito
48.1642.01 Right
48.1645.02 Left

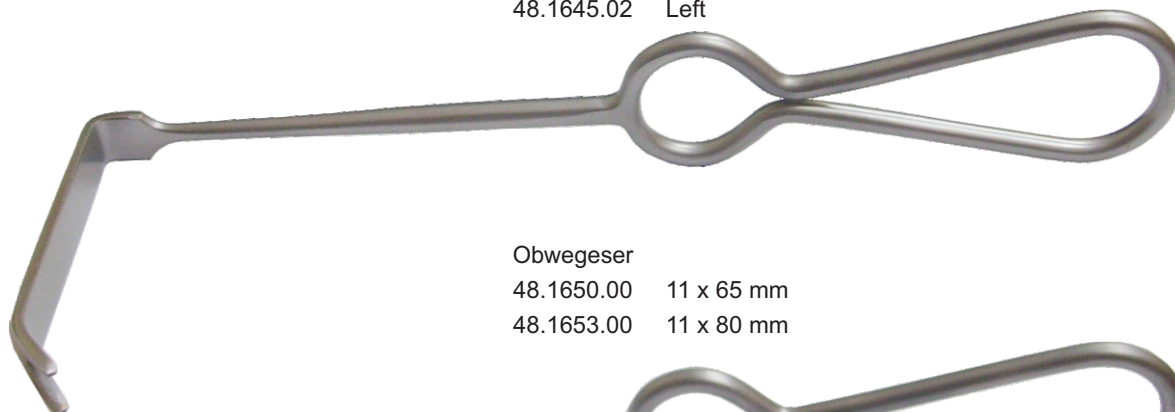

Obwegeser
48.1650.00 11 x 65 mm
48.1653.00 11 x 80 mm

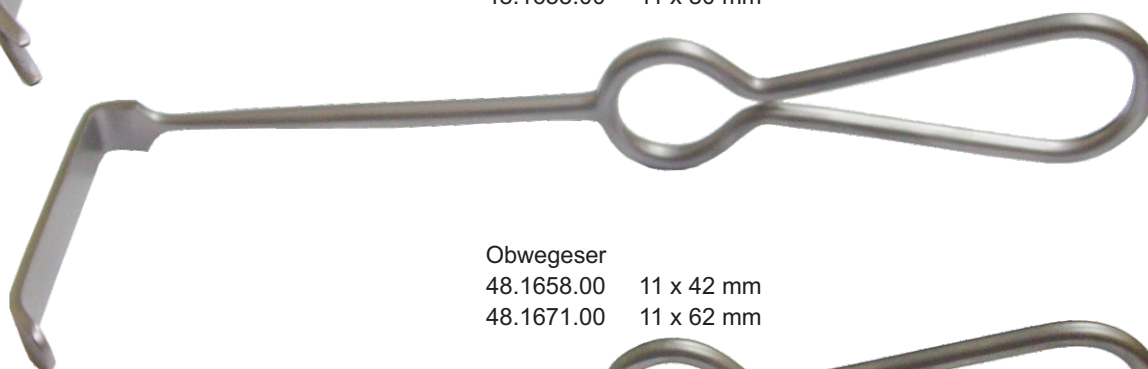

Obwegeser
48.1658.00 11 x 42 mm
48.1671.00 11 x 62 mm



Obwegeser
48.1673.00 11 x 42 mm
48.1676.00 11 x 62 mm

New

Maxillofacial Instruments



Minnesota / Aspirador
48.1679.14
14 cm



Obwegeser
48.1682.17
17 cm

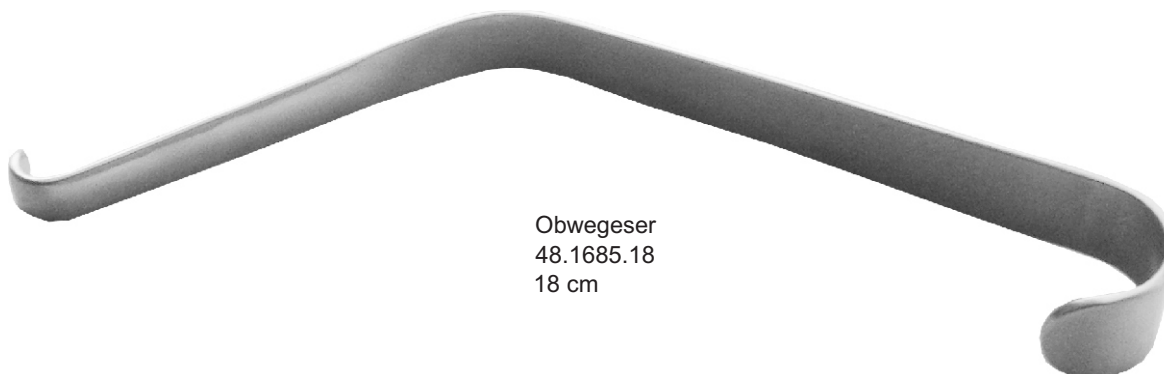

Obwegeser
48.1685.18
18 cm



Wieder
48.1688.00



Bruenings
19 cm
32-303-00

New

Maxillofacial Instruments



Bauer Direito
48.1692.24 Right
48.1695.24 Left
24 cm



Pinca Walshan
32-362-00 Direita
32-366-00 Esquerda



Separador Cavidade
32-305-00

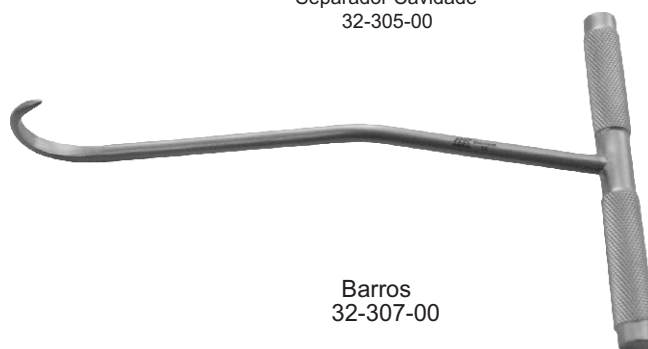

Barros
32-307-00



Obwegeser
32-309-00



Descolador
32-311-00

New

Maxillofacial Instruments



Elevador Seldin
32-315-00



Raspa
32-317-00



Disjuncao Palatina
Sverzut
32-319-00

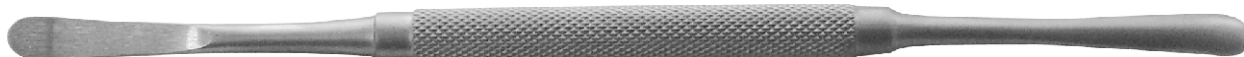

Descolorador Duplo Freer
32-321-00

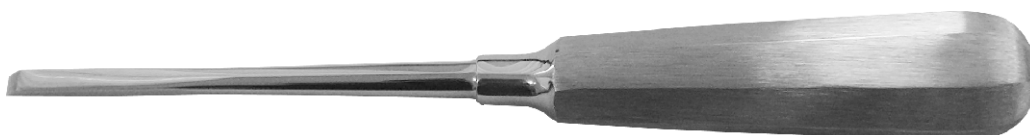

Alexander
32-323-00
18 cm,4mm



Gardner
32-325-00
18 cm,4mm



Alexander
32-327-00
18 cm,4mm

New

Maxillofacial Instruments



Bone Holding Forcep
With Drill Hole Ø 3 mm
17 cm
32-329-00



Bone Holding Forcep
32-331-00



Atrauma Forcep
32-333-00

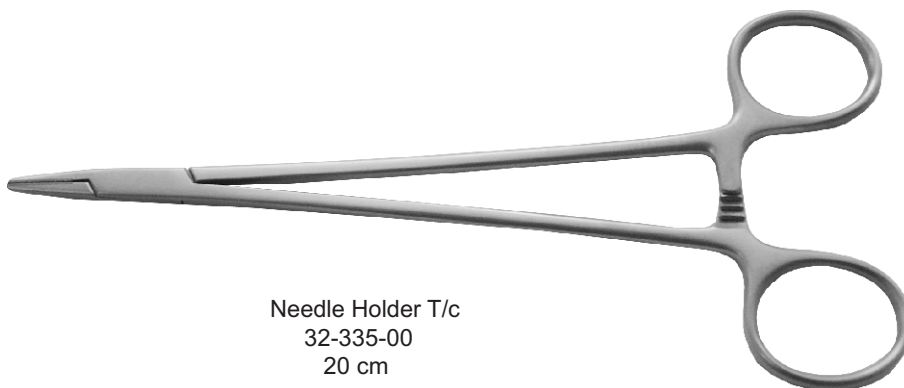

Needle Holder T/c
32-335-00
20 cm

New

Laboratory Sets



27-052-00	P.K Thomas 1
27-053-00	P.K Thomas 2
27-054-00	P.K Thomas 3
27-055-00	P.K Thomas 4
27-056-00	P.K Thomas 5
16-310-11	Iris Scissor Cvd 11 cm
18-007-12	Mosquito Forcep Str 12 cm
25-059-00	Scalple handle # 3
27-017-00	Zahle
27-019-00	Hylin
27-057-00	Ceramic Sculpturing instruments
27-060-00	Ceramic Sculpturing instruments
27-063-00	Ceramic Sculpturing instruments
32-340-00	Instruments Kit



32-337-00
Laboratory Set

31-074-00	Universal Plier 16 cm
28-337-10	Lwanson Caliper for Metal 10 cm
25-059-00	Scalple handle # 3
16-370-12	Universal Scissor 12cm
16-310-11	Iris Scissor Cvd 11 cm
18-007-12	Mosquito Forcep Str 12 cm
28-286-16	Soldring Tweezer 16 cm
28-012-00	Knif
28-002-17	Wax Knif 17 cm
28-004-17	Wax Knif 17 cm
28-003-13	Wax Knif 13 cm
27-018-00	Zahle
27-020-00	Hylin
27-012-00	Le Cron
32-342-00	Instruments Kit



32-339-00
Laboratory Set

28-010-00	Wax Knife
16-310-11	Iris Scissor Cvd 11 cm
31-006-14	Plier 14 cm
27-080-00	P.K.Thomas 1
27-080-00	P.K.Thomas 2
27-080-00	P.K.Thomas 3
27-080-00	P.K.Thomas 4
27-080-00	P.K.Thomas 5
25-059-00	Scalple handle # 3
02-004-02	Meriam Tweezer 16cm
28-286-16	Soldring Tweezer 16 cm
28-022-17	Wax Knife 17 cm
28-001-13	Wax Knife 13cm
18-007-12	Mosquito Forcep CVD 12 cm
27-012-00	Le Cron
27-017-00	Zahle
32-344-00	Instruments Kit



32-341-00
Laboratory Set

New

Micro Surgery Sets



00-000-00	Adson Tissue Forcep 1x 2 teeth 15 cm
00-000-00	Adson Forceps 12 cm
00-000-00	Gillies Hook
19-123-00	Castroviejo Neendle Holder T/c 14 cm
33-053-18	Castroviejo Micro Scissor 18 cm
19-114-18	Castroviejo Neendle Holder 18 cm
16-320-15	Castroviejo Scissor 15cm
02-157-00	Gerald forcep 18cm
60-763-00	Casette Tray ,290x180x35mm

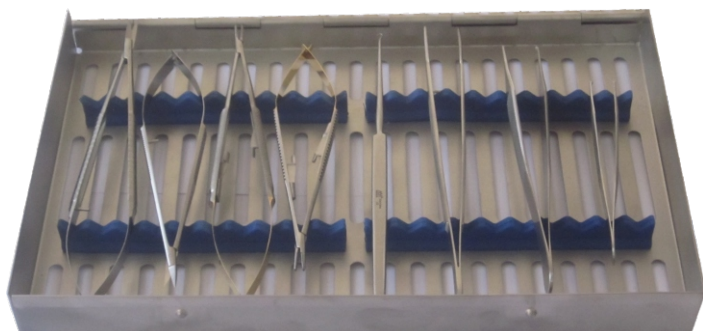

32-343-00
Micro Surgery Set

19-123-14	Castroviejo Neendle Holder T/c 14 cm
19-079-14	Methieu Needle Holder 14 cm T/c
16-065-15	Metzenbaum Scissor 15 cm
16-007-10	Spencer Scissor 10 cm
02-009-00	College Tweezer 15cm
25-058-00	Scalpel handle # 04
32-348-00	Mirror handle With Mirror # 4
02-165-01	Semken Forceps 12.5 cm
02-093-15	Crane Kaplan 15 cm
32-346-00	Hook 2 prong wih ball
60-763-00	Casette Tray ,290x180x35mm



32-345-00
Micro Surgery Set

32-350-00	Micro Neendle Holde Round Tc 18
32-352-00	Micro Neendle Holde Round Tc 15
32-354-00	Bone Curette # 85
32-356-00	Castroviejo Scissor 15cm
32-358-00	Molt elevater
32-157-00	Gerald forcep 18cm
60-763-00	Casette Tray ,290x180x35mm

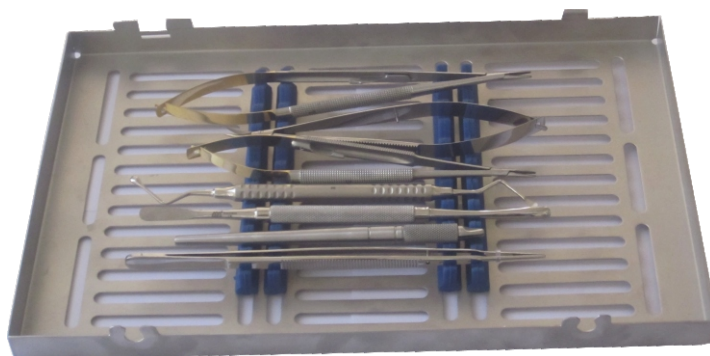

32-347-00
Micro Surgery Set

New

Surgical Sets



21-001-00	Lvory With two Rows of holes
21-012-00	Brewer Rubber Dam
21-015-00	Rubber Dam frame (Small)
60-617-00	Instruments Tray

All Number available Rubber Dam Clamp

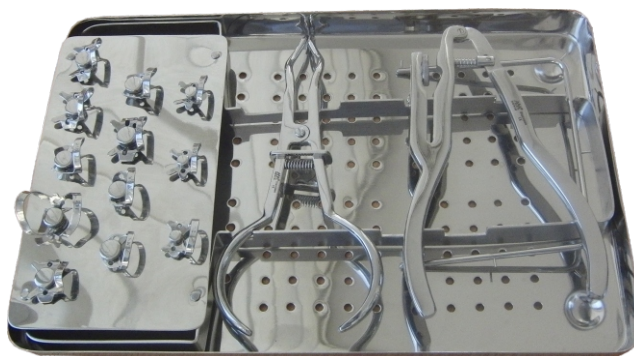

32-349-00
Rubber dam Set

27-052-00	Farabeuf Retractor 15 cm
27-053-00	Scalple handle # 3
27-054-00	Molt elevater
27-055-00	Crile wood needle holder 15 cm t/c
27-056-00	La Grange Scissor 11.5 cm
16-310-11	Adson dressing forceps 15 cm
18-007-12	Bone Curette heming way
25-059-00	Saliva Ejectors
60-617-00	Instruments Tray

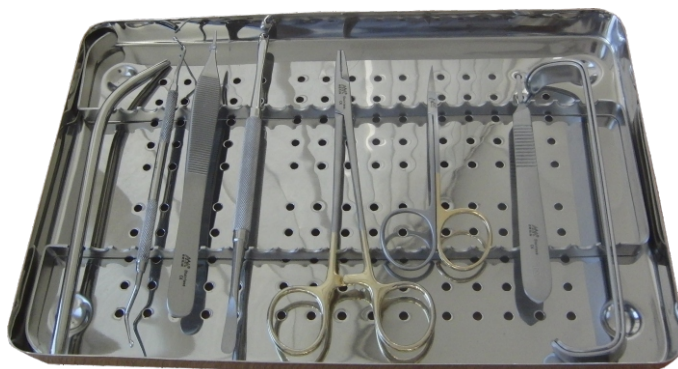

32-351-00
Surgical Set

27-052-00	Ryder Needle Holder T/c 13 cm
16-300-11	La Grange Scissor 11.5 cm
33-377-00	Bone Carrier
25-059-00	Scalple handle # 3
03-014-00	Molt elevater
24-001-00	Mouth mirror handle
12-023-14	Bone Curette heming way
12-003-17	Bone Curette lucas
17-029-00	Senn-Mueller Retractor
25-059-00	Saliva Ejectors
60-617-00	Instruments Tray

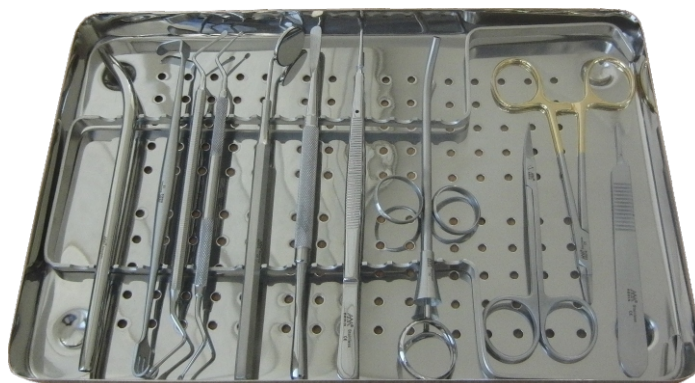

32-353-00
Surgical Set

New

Surgical Sets



19-094-15	Crile wood needle holder 15 cm t/c
19-079-14	Methieu Needle Holder 14 cm
18-006-12	Mosquito Forcep Str 12 cm
16-122-13	Goldman Fox Scissor 13 cm
02-004-02	Meriam Tweezer
32-350-00	Simkin tissue Forcep 12 cm
24-010-00	Mouth mirror handle with Mirror
08-013-00	Explor # 5
03-014-00	Molt elevater
25-059-00	Farabeuf Retractor
17-029-00	Senn-Mueller Retractor
17-013-14	Sternberg Retractor
24-513-00	Arban Scaler S/end
60-617-00	Instruments Tray

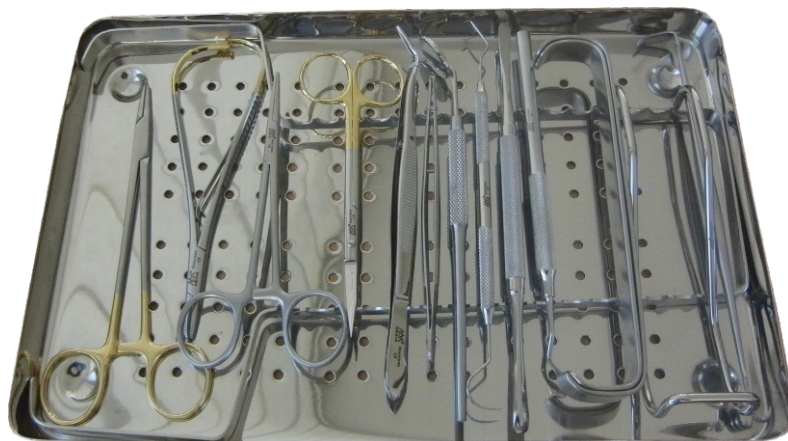

32-355-00
Surgical Set

19-123-14	Castroviejo Neendle Holder T/c 14 cm
19-015-14	Methieu Needle Holder 14 cm T/c
16-302-13	Goldman Fox Scissor 13 cm ,STR
16-303-13	Goldman Fox Scissor 13 cm , CVD
06-114-00	Gracey Curette 13/14
06-111-00	Gracey Curette 7/8
03-014-00	Molt elevater
12-002-01	Bone Curette heming way
12-023-14	Bone Curette
25-059-00	Scalple handle # 5
25-060-00	Scalple handle # 5 CVD
03-079-00	Ochsenbein Chisel
03-080-00	Ochsenbein Chisel
A11032	Cement Spatula Plain handle
32-217-00	Gracey Curette 3/4
24-513-00	Arban Scaler
60-617-00	Instruments Tray

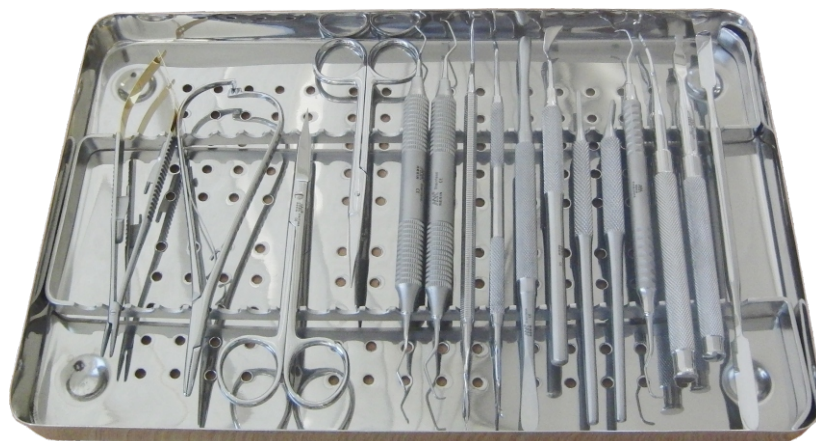

32-357-00
Surgical Set

Certified:

ISO 9001 :2008

ISO 14001 : 2004

ISO 13485 : 2003

cGMP - FDA (USA)



M.A. ARAIN & BROTHERS (PVT.) LTD.

Mailing Address:

P.O.Box 432,Sialkot -Pakistan

Factory:

Wazirabab Road ,Sialkot-Pakistan

Phone : +92 52 4264926 - 4264571

Fax: +92 52 4264759 - 4264026

E-mail: info@maarain.com

URL: www.maarain.com