

Micro Instruments





Introduction

M.A. ARAIN & BROTHERS (Pvt.) Ltd.

Pursues the 21st century vision of becoming a true global leader who can make its Customers worldwide through its quality products and services.

We are dedicated to manufacturing and marketing instruments those provide practical Solutions to real life problems, and meet the needs of our customers. We insist on high quality, efficient manufacturing teamwork, and integrity, growing from our deep respect and honor for god, our employees, our vendors, our customers and all our other stakeholders.

We stand behind every product we offer. Each of us, from the production department to the sales department makes customer satisfaction a top priority.

The careful management of people and projects ensures we continue to enjoy our reputation for providing excellent quality services to our customers.

The most important part of our philosophy is to work in partnership with clients and this requires, in our view, direct contact between our clients and us from the word go.

We aim:

- To listen to our customers and exceed their expectations, ensuring they are completely satisfied with our products, services and support so that they will continue working with us.
- To continue expanding our research programs in progressive technologies.
- To secure international recognition by adopting a global rather than local perspective and by achieving excellence in the quality of our instruments.
- To continue building our excellent team of top professionals through controlled expansion, selective recruitment and by creating an informal and challenging work environment.

Contents

Micro Scissors	01 - 12
Micro Forceps	13 - 25
Micro Needle Holders	26 - 39



VANNAS

8 cm - 3¼"

65-1001-08

65-1002-08

Vannas-blade



12 cm - 4¾"

Blade 10 mm, sharp



65-1003-12

Straight



65-1004-12

Curved



65-1005-12

Straight



65-1006-12

Curved



65-1007-12

Angled up





12 cm - 4¾"

Vannas-blade





Micro scissors
 Micro ciseaux à ressorts
 Micro tijeras con resorte
 Forbici per microchirurgia









			
15 cm - 6"	65-1008-15	65-1009-15	65-1010-15
	<i>Straight, short blades</i>	<i>Curved, short blades</i>	<i>Straight, long blades</i>
			<i>Curved, long blades</i>



	
15 cm - 6"	65-1012-16
	<i>Straight, saw edge</i>
	<i>Curved, saw edge</i>

15 cm - 6"
65-1014-15
18 cm - 7"
65-1015-18
<i>Angled on Flat, 45°</i>



		
12 cm - 4¾"	65-1016-12	65-1017-12
Blades 14 mm, smooth, sharp	Straight	Curved
		
12 cm - 4¾"	65-1018-12	65-1019-12
Blades 14 mm, sharp	Straight, saw edge	Curved, saw edge
		
14.5 cm - 5¾"	65-1020-14	65-1021-14
Vannas-blades, smooth, sharp	Straight	Curved





Micro scissors
Micro ciseaux à ressorts
Micro tijeras con resorte
Forbici per microchirurgia

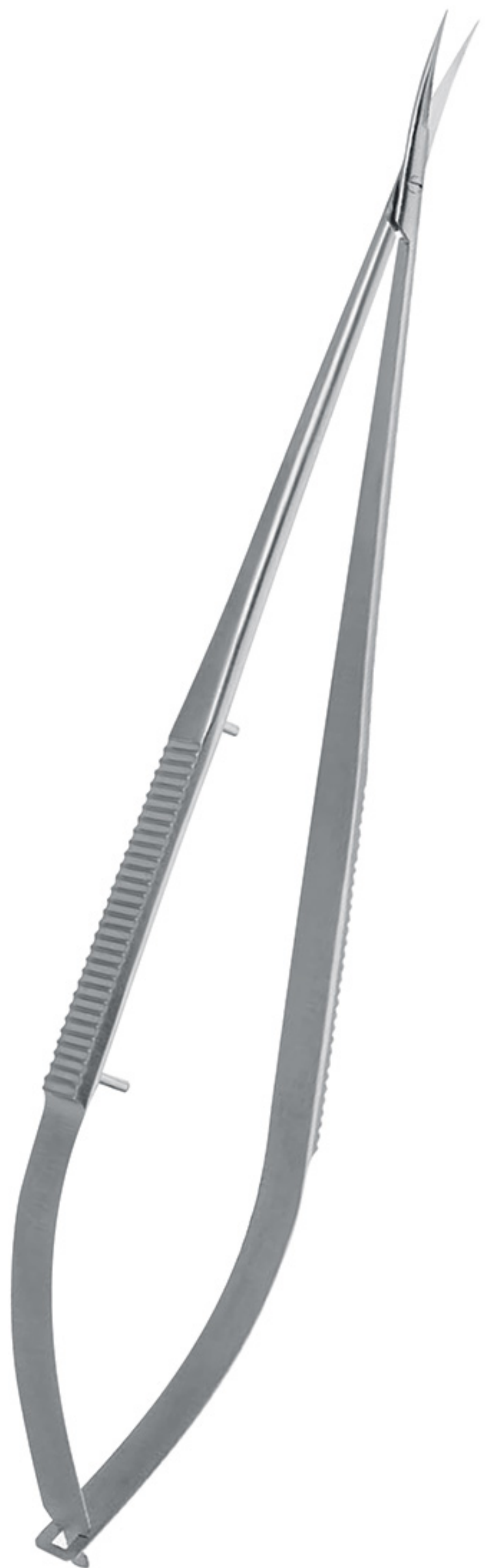

YASARGIL

18.5 cm - 7¼"	65-1022-18	65-1023-18	65-1024-18
	<i>Straight</i>	<i>Curved</i>	<i>Angled on flat</i>





YASARGIL

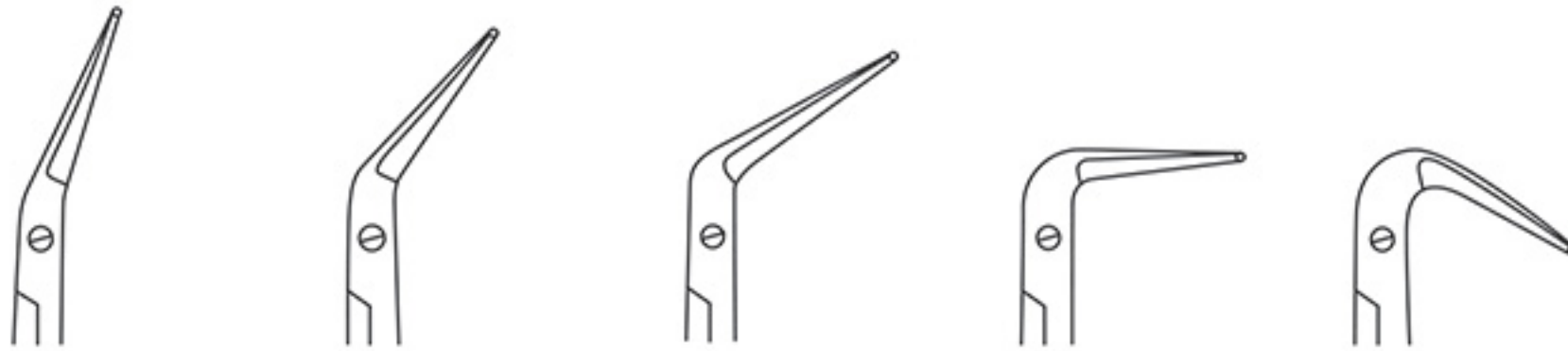

	25°	45°	60°	90°	125°
17 cm - 6¾"	65-1025-17	65-1026-17	65-1027-17	65-1028-17	65-1029-17

with ball

YASARGIL

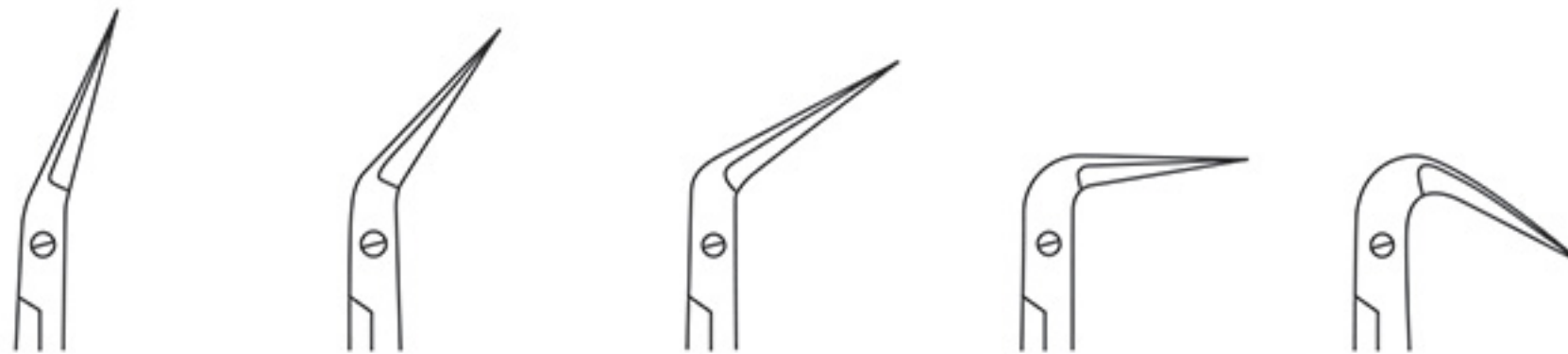

	25°	45°	60°	90°	125°
17 cm - 6¾"	65-1030-17	65-1031-17	65-1032-17	65-1033-17	65-1034-17

without ball

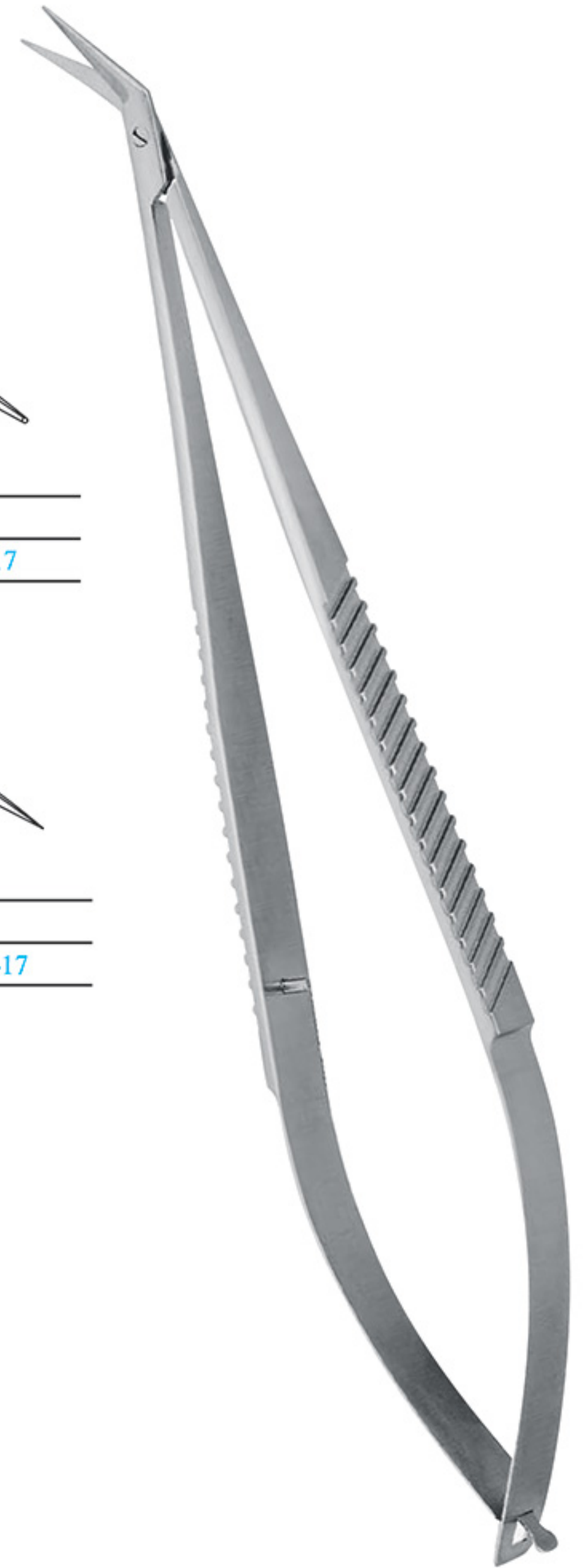



Micro scissors
 Micro ciseaux à ressorts
 Micro tijeras con resorte
 Forbici per microchirurgia

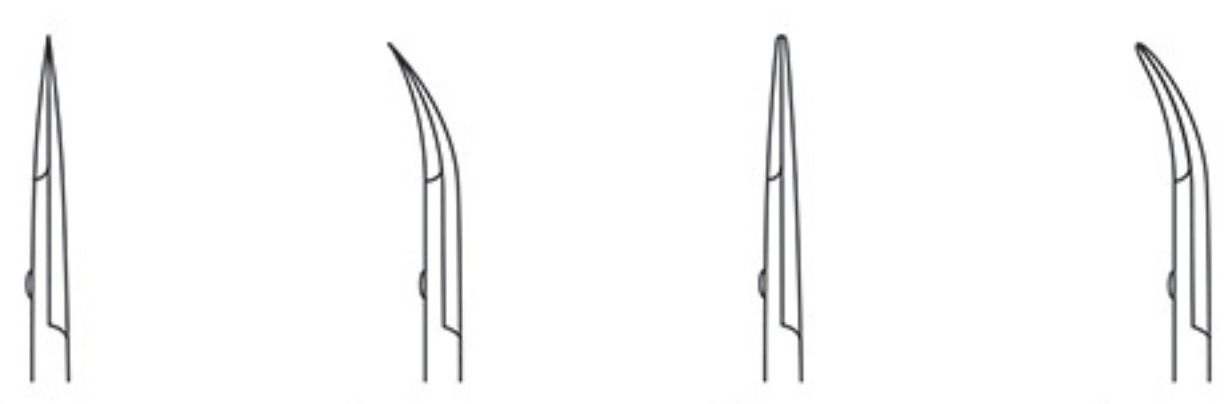

14.5 cm - 5¾"	65-1035-14	65-1037-14	65-1039-14	65-1041-14
18 cm - 7"	65-1036-18	65-1038-18	65-1040-18	65-1042-18
<i>Blades 8 mm, smooth</i>	<i>straight, sharp</i>	<i>curved, sharp</i>	<i>straight, blunt</i>	<i>Curved, blunt</i>

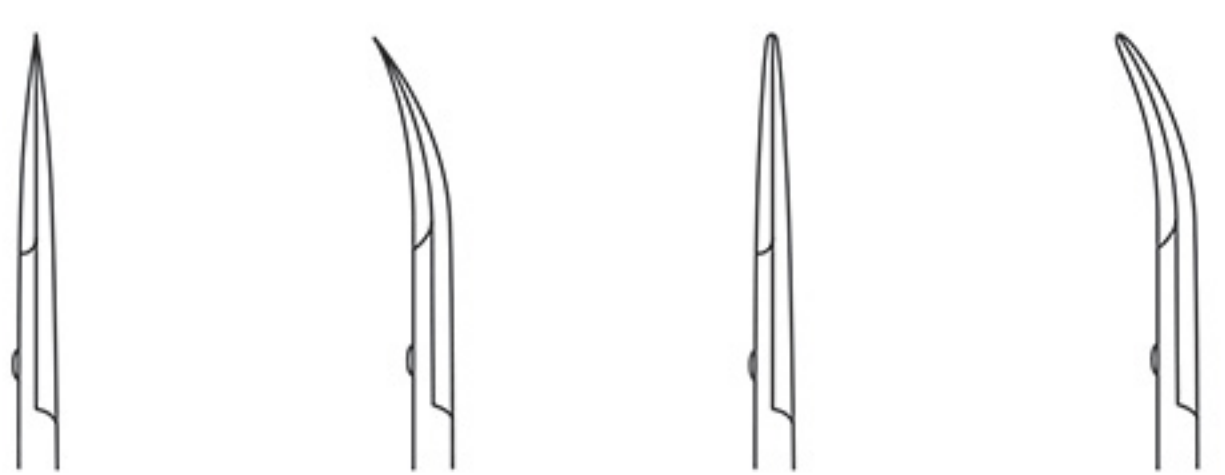

14.5 cm - 5¾"	65-1043-14	65-1045-14	65-1047-14	65-1049-14
18 cm - 7"	65-1044-18	65-1046-18	65-1048-18	65-1050-18
<i>Blades 14 mm, smooth</i>	<i>straight, sharp</i>	<i>curved, sharp</i>	<i>straight, blunt</i>	<i>Curved, blunt</i>

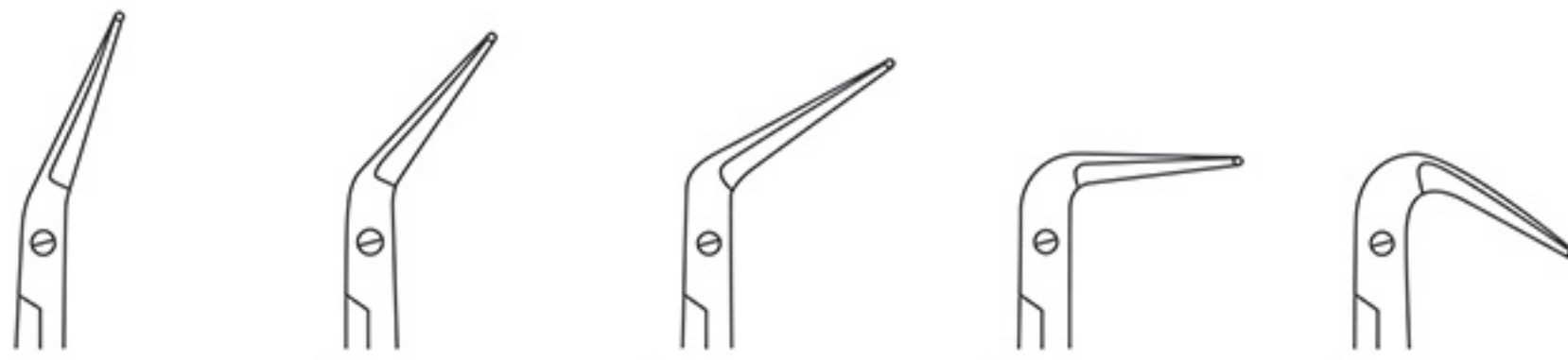
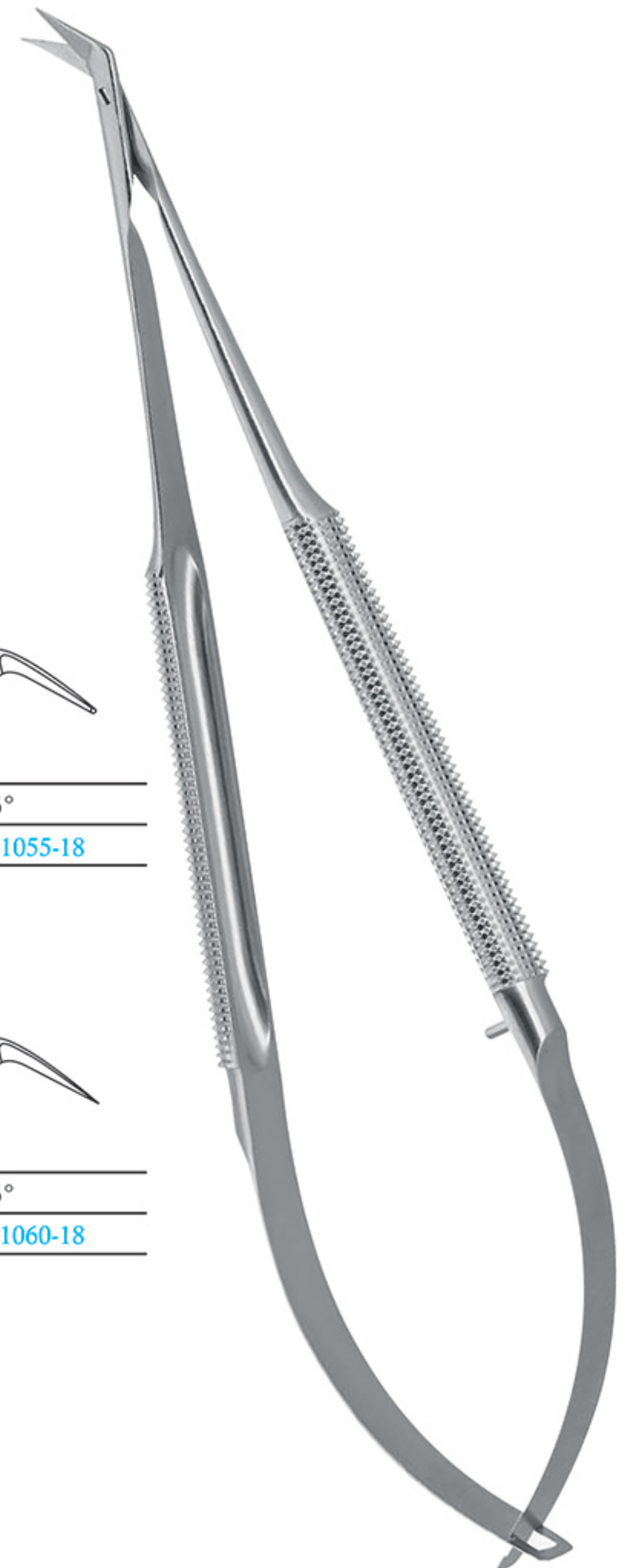

	25°	45°	60°	90°	125°
18 cm - 7"	65-1051-18	65-1052-18	65-1053-18	65-1054-18	65-1055-18

Blade 10 mm, with ball, sharp

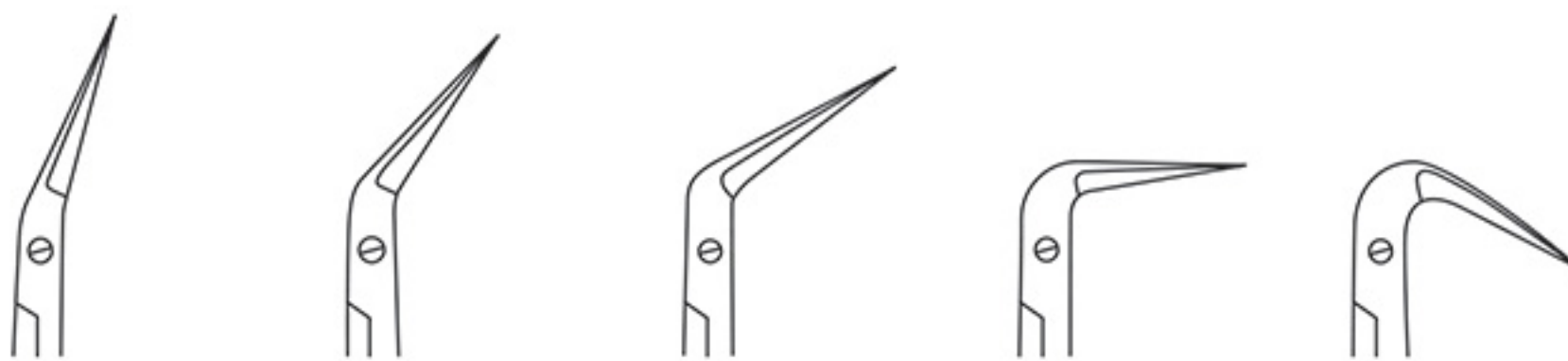

	25°	45°	60°	90°	125°
18 cm - 7"	65-1056-18	65-1057-18	65-1058-18	65-1059-18	65-1060-18

Blade 10 mm, without ball, sharp



Micro scissors
 Micro ciseaux à ressorts
 Micro tijeras con resorte
 Forbici per microchirurgia

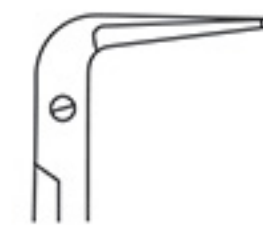
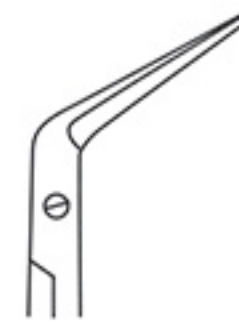
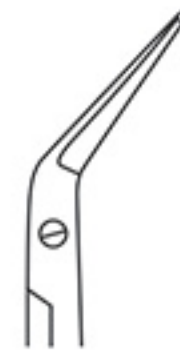

	25°	45°	60°	90°	125°
18 cm - 7"	65-1061-18	65-1062-18	65-1063-18	65-1064-18	65-1065-18

with ball

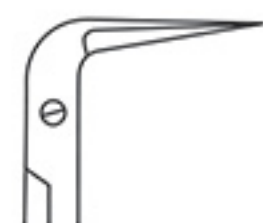
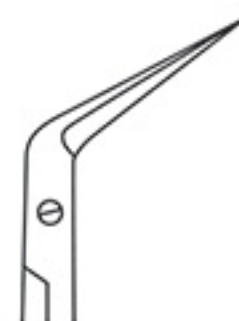

	25°	45°	60°	90°	125°
18 cm - 7"	65-1066-18	65-1067-18	65-1068-18	65-1069-18	65-1070-18

without ball

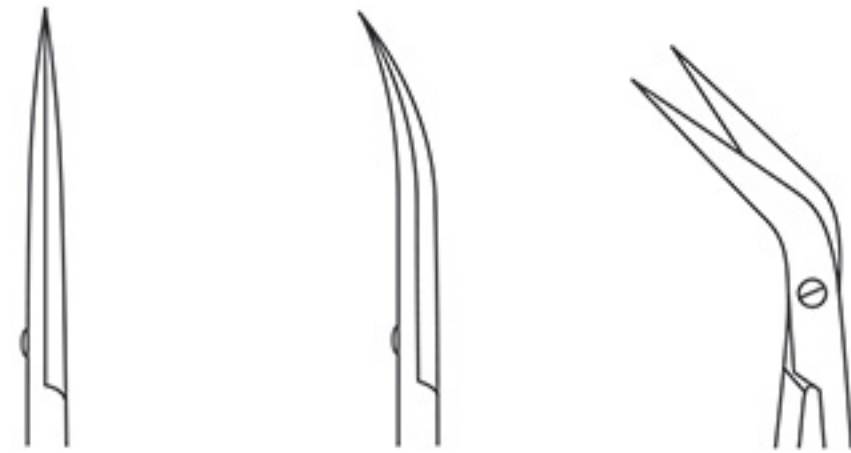

JACOBSON

16 cm - 6¼"	65-1071-16	65-1073-16	65-1075-16
18 cm - 7"	65-1072-18	65-1074-18	65-1076-18
	<i>straight</i>	<i>curved</i>	<i>angled, 45°</i>

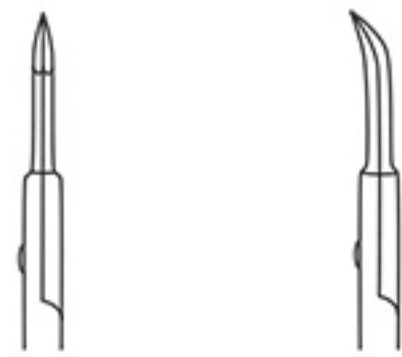

16 cm - 6¼"	65-1077-16	65-1079-16
18 cm - 7"	65-1078-18	65-1080-18
	<i>vannas blade</i>	

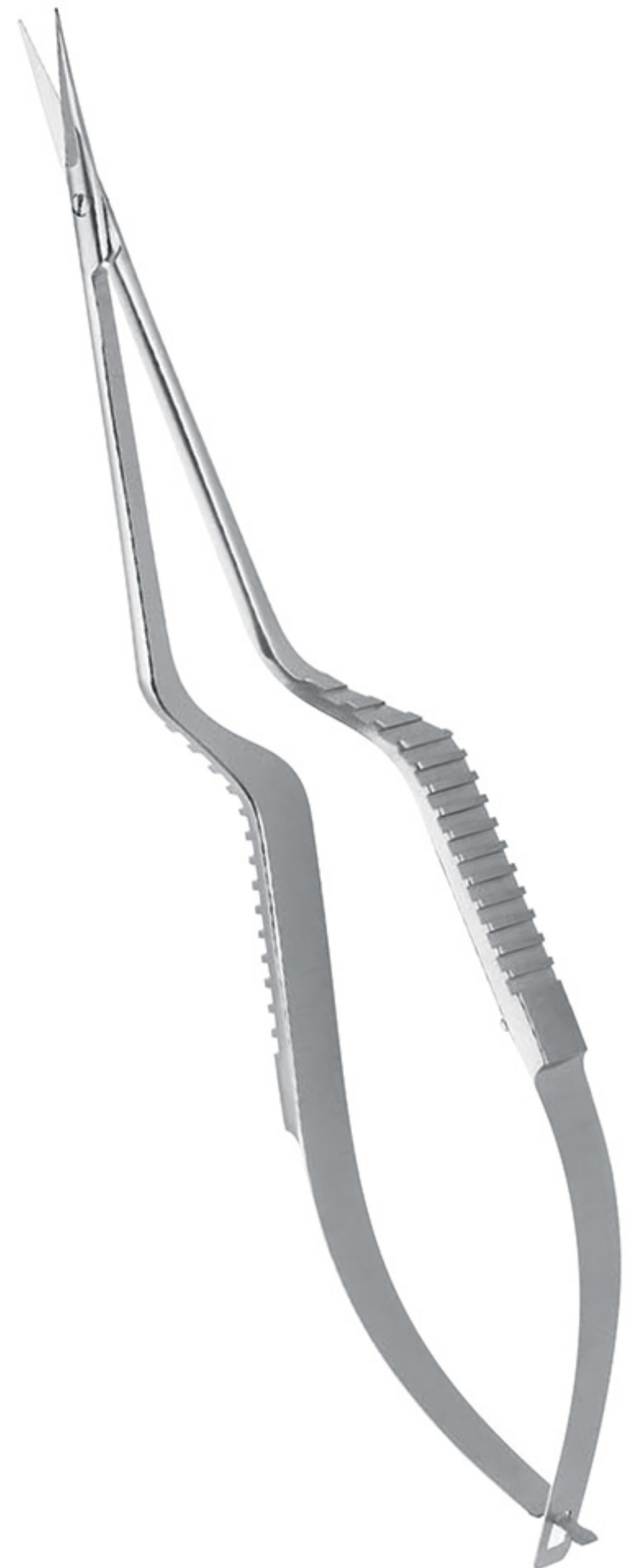



Micro scissors
 Micro ciseaux à ressorts
 Micro tijeras con resorte
 Forbici per microchirurgia



YASARGIL -
 MOS.

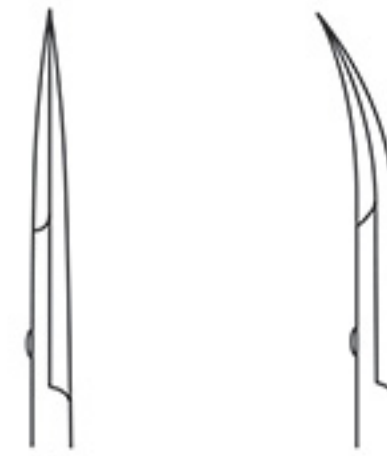

18 cm - 7"	65-1081-18	65-1083-18
22.5 cm - 8¾"	65-1082-22	65-1084-22

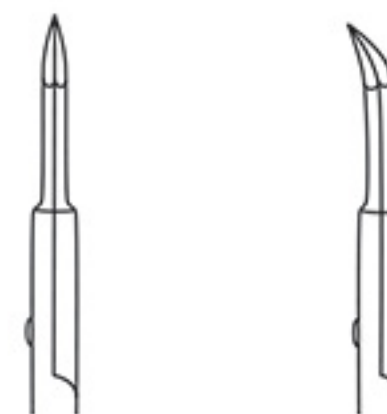

22.5 cm - 8¾"	65-1085-22	65-1086-22
---------------	------------	------------

vanna blade

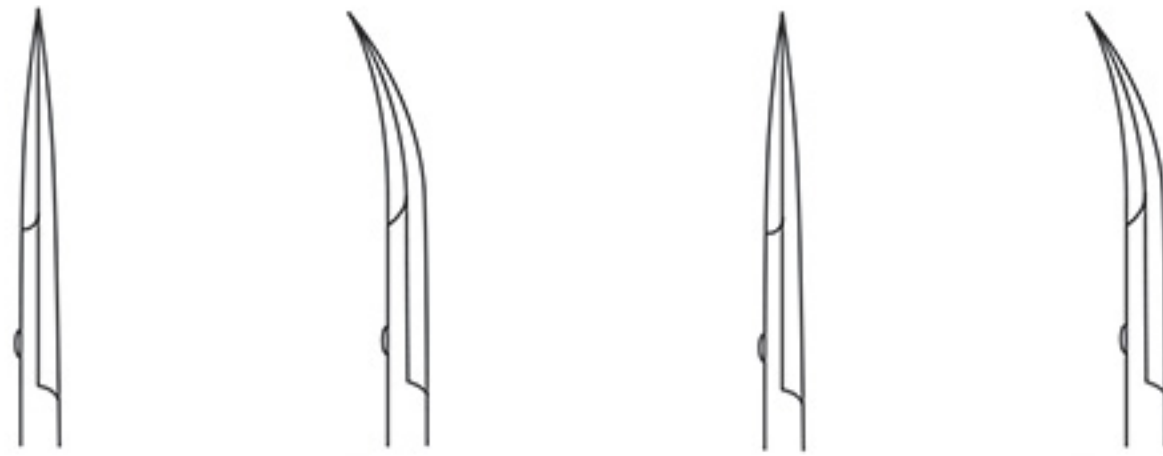

10 cm - 8"	65-1087-10	65-1089-10	65-1091-10	65-1093-10
22.5 cm - 8¾"	65-1088-22	65-1090-22	65-1092-22	65-1094-22
<i>Blade smooth, sharp</i>	<i>straight</i>	<i>curved</i>	<i>straight, saw edge</i>	<i>curved, saw edge</i>

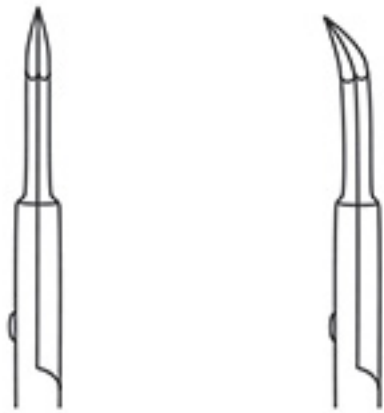

10 cm - 8"	65-1095-10	65-1097-10
22.5 cm - 8¾"	65-1096-22	65-1098-22
<i>vannas blade</i>		

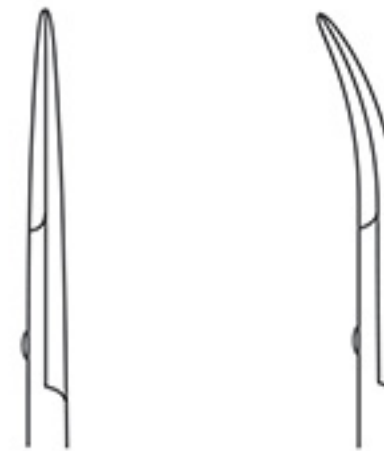

10 cm - 8"	65-1099-10	65-1101-10
22.5 cm - 8¾"	65-1100-22	65-1102-22
<i>dissector blade, blunt</i>		

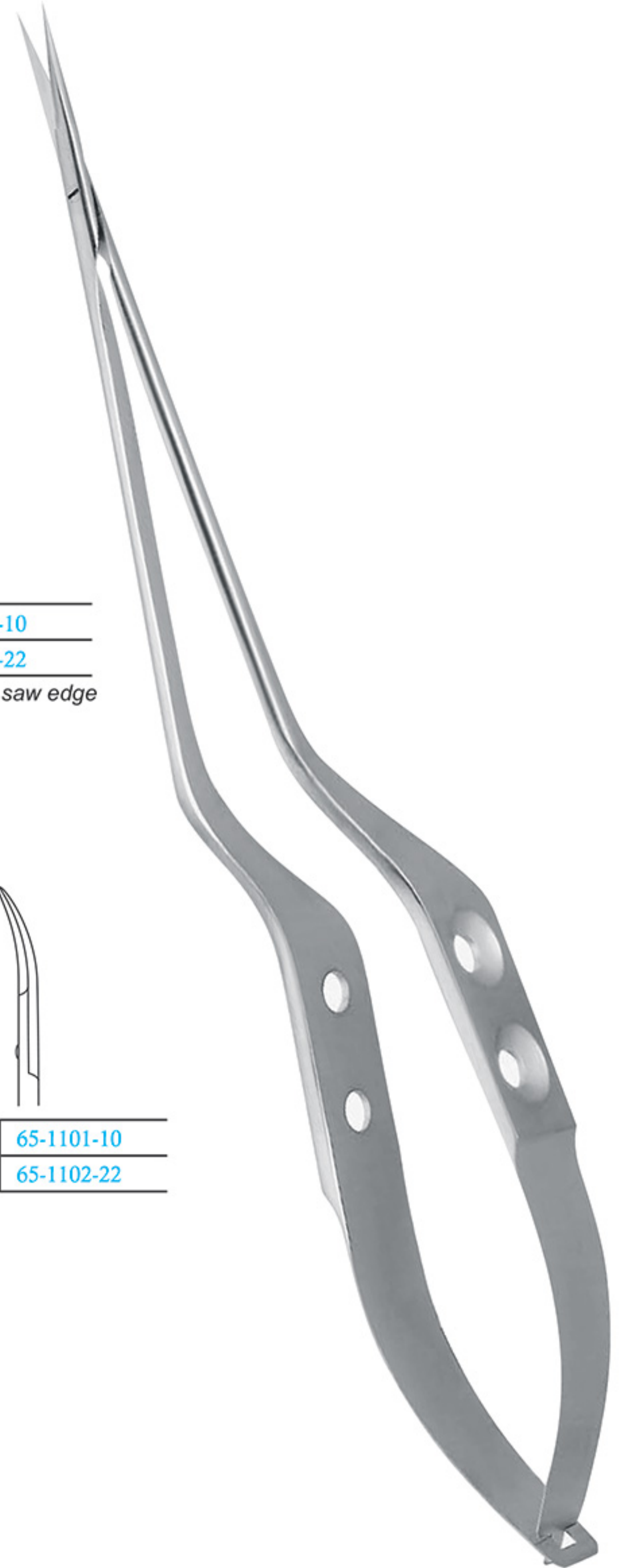



Micro scissors
 Micro ciseaux à ressorts
 Micro tijeras con resorte
 Forbici per microchirurgia



YASARGIL

23 cm / 9"	65-1103-23	65-1104-23	65-1105-23	65-1106-23	65-1107-23
Blade 14 mm	straight	curved up	curved down	Vannas-Straight	Vannas-curved up

YASARGIL

23 cm / 9"	65-1108-23	65-1109-23
Blade 27 mm	straight	curved up



	9 mm Ø	9 mm Ø	9 mm Ø	9 mm Ø
18 cm - 7"	65-1117-18	65-1118-18	65-1119-18	65-1120-18
6.0 mm x 0.4 mm, smooth			1x2	1x2

	9 mm Ø	9 mm Ø	9 mm Ø	9 mm Ø
18 cm - 7"	65-1121-18	65-1122-18	65-1123-18	65-1124-18
6.0 mm x 0.4 mm, <i>diamond coated</i>			1x2	1x2



Diamond coated



8 mm Ø	0.3 mm	0.3 mm	0.7 mm	0.7 mm
15 cm - 6"	65-1133-15	65-1137-15	65-1141-15	65-1145-15
18 cm - 7"	65-1134-18	65-1138-18	65-1142-18	65-1146-18
21 cm - 8¼"	65-1135-21	65-1139-21	65-1143-21	65-1147-21
23 cm - 9"	65-1136-23	65-1140-23	65-1144-23	65-1148-23

smooth Jaw



8 mm Ø	0.3 mm	0.3 mm	0.7 mm	0.7 mm
15 cm - 6"	65-1149-15	65-1153-15	65-1157-15	65-1161-15
18 cm - 7"	65-1150-18	65-1154-18	65-1158-18	65-1162-18
21 cm - 8¼"	65-1151-21	65-1155-21	65-1159-21	65-1163-21
23 cm - 9"	65-1152-23	65-1156-23	65-1160-23	65-1164-23

6.0 x 0.3 mm, smooth Jaw

1x2

1x2





	0.3 mm	0.3 mm	0.7 mm	0.7 mm
8 mm Ø				
15 cm - 6"	65-1181-15	65-1185-15	65-1189-15	65-1193-15
18 cm - 7"	65-1182-18	65-1186-18	65-1190-18	65-1194-18
21 cm - 8¼"	65-1183-21	65-1187-21	65-1191-21	65-1195-21
23 cm - 9"	65-1184-23	65-1188-23	65-1192-23	65-1196-23



	0.3 mm	0.3 mm	0.7 mm	0.7 mm
8 mm Ø				
15 cm - 6"	65-1197-15	65-1201-15	65-1205-15	65-1209-15
18 cm - 7"	65-1198-18	65-1202-18	65-1206-18	65-1210-18
21 cm - 8¼"	65-1199-21	65-1203-21	65-1207-21	65-1211-21
23 cm - 9"	65-1200-23	65-1204-23	65-1208-23	65-1212-23

6.0 x 0.3 mm ,diamond coated

1x2

1x2





JACOBSON		
16 cm - 6¼"	65-1229-16	65-1231-16
18 cm - 7"	65-1230-18	65-1232-18
	<i>straight, sharp</i>	<i>straight, blunt</i>





YASARGIL

			
	12.5 cm - 8 ³ / ₄ "	12.5 cm - 8 ³ / ₄ "	12.5 cm - 8 ³ / ₄ "
3.0 mm	65-1233-12	65-1235-12	65-1237-12
5.0 mm	65-1234-12	65-1236-12	65-1238-12
	<i>spoon form</i>	<i>plan toothed</i>	<i>curette form</i>





Micro Forceps
Micro pincers
Micro pinzas
Pinze per microchirurgia



20 cm - 8"	65-1239-20	65-1241-20
22.5 cm - 8¾"	65-1240-22	65-1242-22
	<i>straight, sharp</i>	<i>straight, blunt</i>



		
	9 mm Ø	9 mm Ø
21 cm - 8¼"	65-1243-21	65-1245-21
23 cm - 9"	65-1244-23	65-1246-23
	<i>straight, sharp</i>	<i>straight, blunt</i>



Micro Forceps
 Micro pincers
 Micro pinzas
 Pinze per microchirurgia



9 mm Ø	1.0x0.5 mm	1.0x0.5 mm	2.0x1.0 mm	2.0x1.0 mm
15 cm - 6"	65-1247-15	65-1251-15	65-1255-15	65-1259-15
18 cm - 7"	65-1248-18	65-1252-18	65-1256-18	65-1260-18
21 cm - 8¼"	65-1249-21	65-1253-21	65-1257-21	65-1261-21
23 cm - 9"	65-1250-23	65-1254-23	65-1258-23	65-1262-23
	<i>smooth</i>	<i>slightly serrated</i>	<i>smooth</i>	<i>slightly serrated</i>



9 mm Ø	1.0x0.5 mm	2.0x1.0 mm
15 cm - 6"	65-1263-15	65-1267-15
18 cm - 7"	65-1264-18	65-1268-18
21 cm - 8¼"	65-1265-21	65-1269-21
23 cm - 9"	65-1266-23	65-1270-23

diamond coated



Diamond coated



9 mm Ø	1.0 mm x 0.5 mm	1.0 mm x 0.5 mm	2.0 mm x 1.0 mm	2.0 mm x 1.0 mm
21 cm - 8¼"	65-1271-21	65-1273-21	65-1275-21	65-1277-21
23 cm - 9"	65-1272-23	65-1274-23	65-1276-23	65-1278-23
	<i>smooth</i>	<i>serrated</i>	<i>smooth</i>	<i>serrated</i>



Micro Forceps
 Micro pinces
 Micro pinzas
 Pinze per microchirurgia

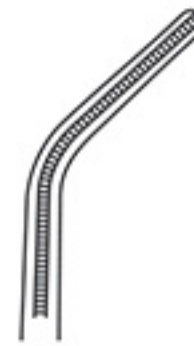
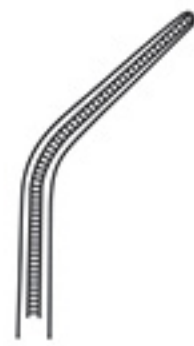
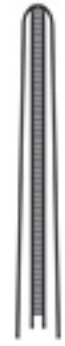

	1.2 mm	2.0 mm	1.2 mm	2.0 mm
15 cm - 6"	65-1283-15	65-1287-15	65-1291-15	65-1295-15
18 cm - 7"	65-1284-18	65-1288-18	65-1292-18	65-1296-18
21 cm - 8¼"	65-1285-21	65-1289-21	65-1293-21	65-1297-21
23 cm - 9"	65-1286-23	65-1290-23	65-1294-23	65-1298-23
	<i>straight</i>	<i>straight</i>	<i>angled</i>	<i>angled</i>



YASARGIL

Abm. / Dim.	1,2 mm
18 cm / 7"	65-1299-18



1 x 2 teeth



Abm. / Dim.	0,6 mm	0,9 mm
23 cm / 9"	65-1300-23	65-1301-23



YASARGIL

Abm. / Dim.	Ø 3,0 mm
22 cm / 8 3/4"	65-1302-22

*angled
 delicate serrated
 spoon-shaped jaws with 16 teeth*



YASARGIL

Abm. / Dim.	Ø 3,0 mm	Ø 5,0 mm
22 cm / 8 3/4"	65-1303-22	65-1305-22
24 cm / 9 1/2"	65-1304-24	65-1306-24

spoon-shaped

smooth jaws



YASARGIL

Abm. / Dim.	Ø 3,0 mm	Ø 5,0 mm
16 cm / 6 1/4"	65-1307-16	65-1310-16
20 cm / 8"	65-1308-20	65-1311-20
22 cm / 8 3/4"	65-1309-22	65-1312-22

*heavily serrated
 spoon-shaped jaws with 14 teeth*



YASARGIL

Abm. / Dim.	Ø 3,0 mm	Ø 5,0 mm
16 cm / 6 1/4"	65-1313-16	65-1316-16
20 cm / 8"	65-1314-20	65-1317-20
22 cm / 8 3/4"	65-1315-22	65-1318-22

*delicate serrated
 spoon-shaped jaws with 16 teeth*





YASARGIL

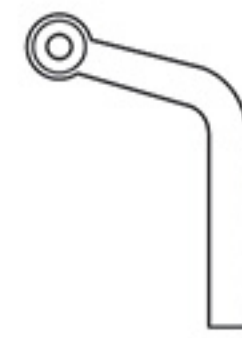

Abm. / Dim.	Ø 3,0 mm	Ø 4,0 mm	Ø 5,0 mm
23 cm / 9"	65-1319-23	65-1320-23	65-1321-23
	<i>spoon-shaped</i>	<i>smooth jaws</i>	<i>curved Upwards</i>

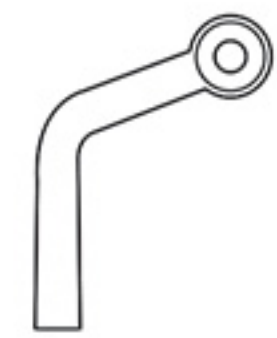
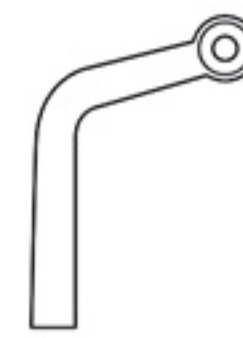

Abm. / Dim.	Ø 3,0 mm	Ø 4,0 mm	Ø 5,0 mm
23 cm / 9"	65-1322-23	65-1323-23	65-1324-23
	<i>spoon-shaped</i>	<i>smooth jaws</i>	<i>curved down</i>



CASTROVIEJO



11.0 mm x 0.75 mm		
14 cm - 5½"	65-1325-14	65-1326-14
<i>with ratchet, fine jaws</i>	<i>straight</i>	<i>curved</i>

CASTROVIEJO





14 cm - 5½"	65-1327-14	65-1328-14
<i>diamond coated</i>	<i>straight</i>	<i>curved</i>





Diamond coated





JACOBSON

		
	1 mm	1 mm
18 cm - 7"	65-1329-18	65-1330-18
	<i>straight</i>	<i>curved</i>

JACOBSON T/C



		
	1 mm	1 mm
18 cm - 7"	65-1331-18	65-1332-18
	<i>straight, smooth</i>	<i>curved, smooth</i>

JACOBSON T/C



		
	1 mm	1 mm
18 cm - 7"	65-1333-18	65-1334-18
	<i>straight, serrated</i>	<i>curved, serrated</i>



YASARGIL



		
18 cm - 7"	65-1335-18	65-1337-18
20 cm - 8"	65-1336-20	65-1338-20
	<i>Straight</i>	<i>curved</i>



YASARGIL



		
18 cm - 7"	65-1339-18	65-1341-18
20 cm - 8"	65-1340-20	65-1342-20
<i>diamond coated</i>	<i>straight</i>	<i>curved</i>





YASARGIL		
		
	1 mm	1 mm
21 cm - 8¼"	65-1343-21	65-1344-21
	<i>straight</i>	<i>curved</i>

YASARGIL T/C		
		
	1 mm	1 mm
21 cm - 8¼"	65-1345-21	65-1346-21
	<i>straight, smooth</i>	<i>curved, smooth</i>

YASARGIL T/C		
		
	1 mm	1 mm
21 cm - 8¼"	65-1347-21	65-1348-21
	<i>straight, serrated</i>	<i>curved, serrated</i>



Micro Needle Holders
Micro porte aiguilles
Micro porta agujas
Micro porta aghi





11 cm - 4¼"	8 mm Ø	65-1349-11	65-1356-11
12.5 cm - 5"	7 mm Ø	65-1350-12	65-1357-12
13 cm - 5"	8 mm Ø	65-1351-13	65-1358-13
13 cm - 5"	10 mm Ø	65-1352-13	65-1359-13
15 cm - 6"	8 mm Ø	65-1353-15	65-1360-15
18 cm - 7"	8 mm Ø	65-1354-18	65-1361-18
18 cm - 7"	10 mm Ø	65-1355-18	65-1362-18

with ratchet *straight* *curved*



BARRAQUER



14 cm - 5½"	8 mm Ø	 65-1363-14	 65-1364-14
<i>with ratchet, extra delicate jaws</i>		<i>straight</i>	<i>curved</i>



Micro Needle Holders
Micro porte aiguilles
Micro porta agujas
Micro porta aghi



 **Titanium**

		
	0.8 mm x 0.8 mm	0.8 mm x 0.8 mm
18.5 cm - 7 1/4"	65-1365-18	65-1366-18







Micro Needle Holders
Micro porte aiguilles
Micro porta agujas
Micro porta aghi



 Titanium

		
	0.3 mm x 0.4 mm	0.3 mm x 0.4 mm
18 cm - 7"	65-1367-18	65-1368-18







Micro Needle Holders
Micro porte aiguilles
Micro porta agujas
Micro porta aghi



 **Titanium**





				
	0.4x0.6 mm	0.4x0.6 mm	0.6x0.6 mm	0.6x0.6 mm
20 cm - 8"	65-1369-20	65-1370-20	65-1371-20	65-1372-20



Micro Needle Holders
Micro porte aiguilles
Micro porta agujas
Micro porta aghi



 Titanium

		
	0.5 mm x 0.8 mm	0.5 mm x 0.8 mm
20 cm - 8"	65-1373-20	65-1374-20



Micro Needle Holders
Micro porte aiguilles
Micro porta agujas
Micro porta aghi



		
22.5 cm - 8 ³ / ₄ "	65-1375-22	65-1376-22





	0.4 mm	0.4 mm	0.9 mm	0.9 mm
20 cm - 8"	65-1378-20	65-1381-20	65-1384-20	65-1387-20
22.5 cm - 8¾"	65-1379-22	65-1382-22	65-1385-22	65-1388-22
24 cm - 8½"	65-1380-24	65-1383-24	65-1386-24	65-1389-24
<i>without ratchet</i>	<i>straight</i>	<i>curved</i>	<i>straight</i>	<i>curved</i>



	0.4 mm	0.4 mm	0.9 mm	0.9 mm
20 cm - 8"	65-1390-20	65-1393-20	65-1396-20	65-1399-20
22.5 cm - 8¾"	65-1391-22	65-1394-22	65-1397-22	65-1400-22
24 cm - 8½"	65-1392-24	65-1395-24	65-1398-24	65-1401-24
<i>without ratchet, diamond coated</i>	<i>straight</i>	<i>curved</i>	<i>straight</i>	<i>curved</i>



Diamond coated





JACOBSON		
18 cm - 7"	 65-1402-18	 65-1403-18
<i>without ratchet</i>	<i>straight</i>	<i>curved</i>



JACOBSON		
18 cm - 7"	 65-1404-18	 65-1405-18
<i>diamond coated</i>	<i>straight</i>	<i>curved</i>







Diamond coated



		
9 mm Ø	1.0 mm	1.0 mm
23 cm - 9"	65-1406-23	65-1407-23
<i>with ratchet</i>	<i>straight</i>	<i>curved</i>

		
9 mm Ø	1.0 mm	1.0 mm
23 cm - 9"	65-1408-23	65-1409-23
<i>diamond coated with ratchet</i>	<i>straight</i>	<i>curved</i>

T/C		
23 cm - 9"	65-1410-23	65-1411-23
<i>with ratchet</i>	<i>straight, smooth</i>	<i>curved, smooth</i>

T/C		
23 cm - 9"	65-1412-23	65-1413-23
<i>with ratchet</i>	<i>straight, serrated</i>	<i>curved, serrated</i>

Certified:

ISO 9001 : 2008

ISO 14001 : 2004

ISO 13485 : 2003

cGMP - FDA (USA)

CE 0120



M.A. ARAIN & BROTHERS

Mailing Address:

P.O. Box: 432, Sialkot-Pakistan

Factory:

Wazirabad Road, Sialkot-Pakistan.

Phone: +92 52 4264926 & 4264571

Fax: +92 52 4264759 & 4264026

E-mail: info@maarain.com

URL: www.maarain.com