



M.A. ARAIN & BROTHERS

Taking the pain out of medical procurement

Dental Instruments
Catalogue

w w w . m a a r a i n . c o m

DEPARTMENT #	NAME	FROM PAGE#	TO PAGE#
01	ROOT ELEVATORS.	01	18
02	DRESSING FORCEPS.	19	38
03	PERIOSTEAL ELEVATORS.	39	46
04	EXTRACTING FORCEPS.	47	105
05	PERIODONTAL INSTRUMENTS.	106	114
06	SCALERS.	115	132
07	EXCAVATORS.	133	143
08	PROBES AND EXPLORERS.	144	150
09	ENDODONTIC AND NEVER INSTRUMENTS.	151	154
10	CEMENT SPATULAS.	155	159
11	AMALGAM INSTRUMENTS.	160	168
12	BONE CURETTES.	169	176
13	FILLING INSTRUMENTS.	177	206
14	BONE RONGEUR FORCEPS.	207	216
15	MOUTH GAGS AND TONGUE RETRACTORS.	217	222
16	DISSECTING SCISSORS.	223	234
17	TISSUE RETRACTORS.	235	244
18	ARTERY FORCEPS.	245	253
19	NEEDLE HOLDERS.	254	265
20	INSTRUMENTS BOXES.	266	272
21	RUBBER DAM INSTRUMENTS.	273	280
22	CROWN INSTRUMENTS.	281	287
23	AMALGAM CARRIERS.	288	295
24	MOUTH MIRRORS HANDLES.	296	300
25	SCALPLE HANDLES.	301	304
26	HAMMERS.	305	308
27	CARVING INSTRUMENTS.	309	318
28	WAX KNIVES.	319	331
29	IMPRESSION TRAYS.	332	350
30	TRAYS AND BOWLS.	351	359
31	ORTHODONTICS PLIERS.	360	375
32	SISSORS.	376	382

Department

01

ROOT ELEVATORS
WURZELHEBER
ELEVADORES PARA RAICES

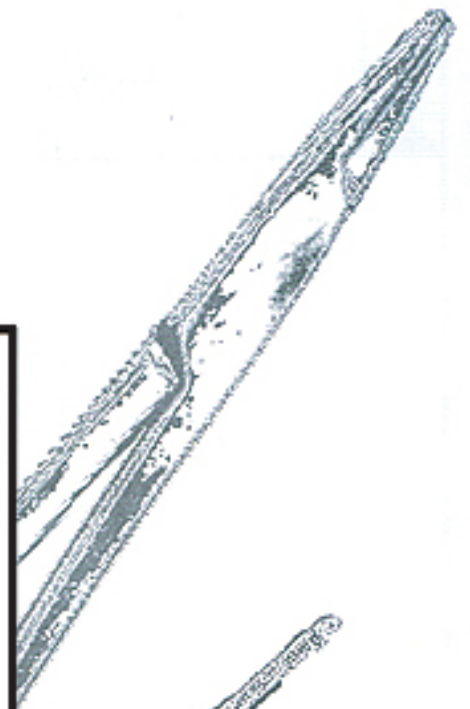
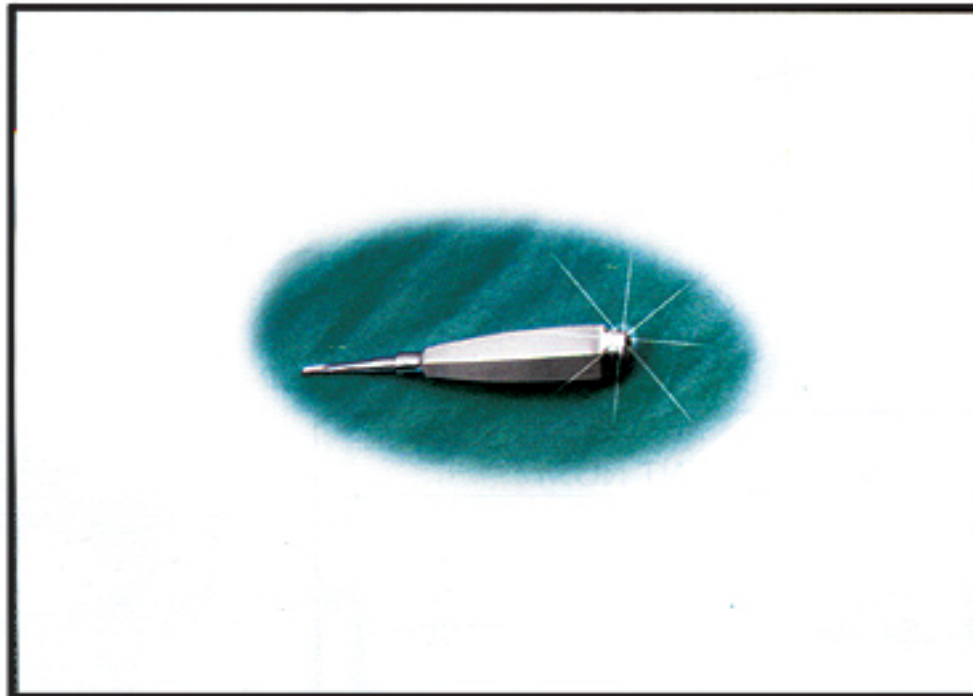

DEPARTMENT NO. 1

FROM
PAGE#

1

TO
PAGE#

18

INSTRUMENTS CATEGORY

ROOT ELEVATORS
WURZELHEBER
ELEVADORES PARA RAICES



ROOT ELEVATORS
WURZELHEBER
ELEVADORES PARA RAICES

01



01-001-00



01-002-00

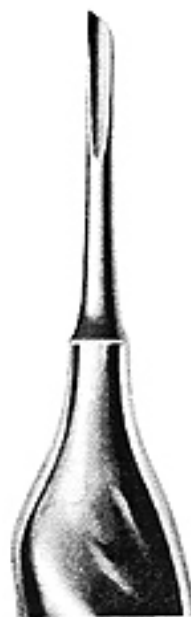

01-003-00



01-004-00



01-005-00

ROOT ELEVATORS
 WURZELHEBER
 ELEVADORES PARA RAICES



ARAIN



9

01-006-09



8

01-006-08



7

01-006-07



6

01-006-06



14

01-006-14



13

01-006-13



12

01-006-12



11

01-006-11



6

01-006-06
Bein



ROOT ELEVATORS
WURZELHEBER
ELEVADORES PARA RAICES

01



1
01-007-01
Bein



2
01-007-02



3
01-007-03



4
01-007-04



5
01-007-05



6
01-007-06



7
01-007-07



8
01-007-08



9
01-007-09



10
01-007-10



11
01-007-11



12
01-007-12

ROOT ELEVATORS
WURZELHEBER
ELEVADORES PARA RAICES



ARAIN

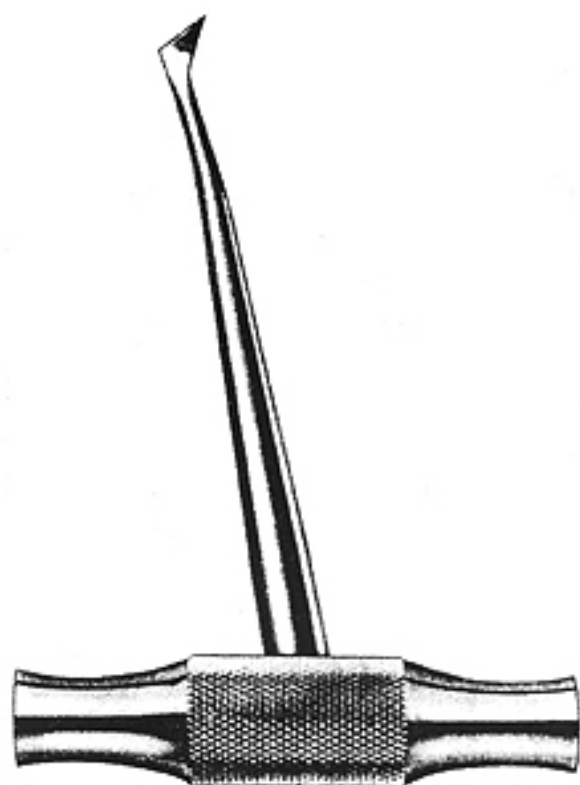

01-058-00
Barry



01-058-01 01-058-02



01-058-03 01-058-04



11 12
01-058-11 01-058-12



17 18
01-058-17 01-058-18



9 10

01-059-09 01-059-10



11 12

01-059-11 01-059-12



13

01-059-13 01-059-14

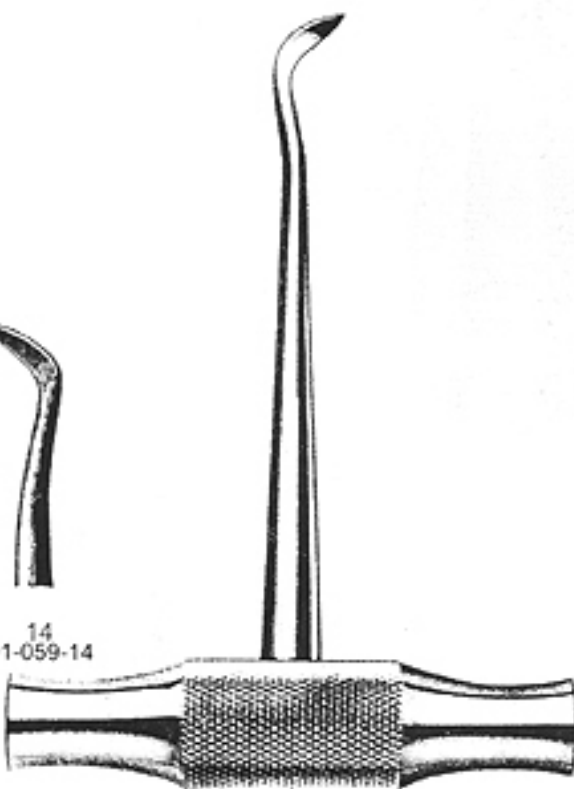

01-059-00
Winter



ROOT ELEVATORS
WURZELHEBER
ELEVADORES PARA RAICES

01



01-110-00
Ratzow

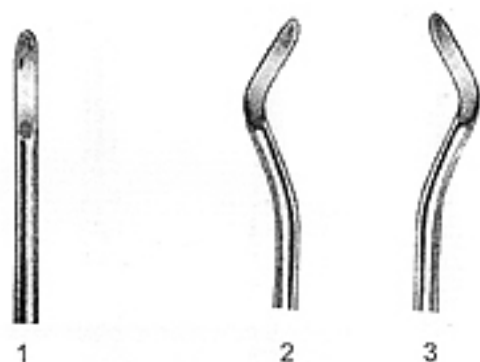

1

2

3

Ratzow

01-110-01

01-110-02

01-110-03



01-111-00
4.5mm
Hylin

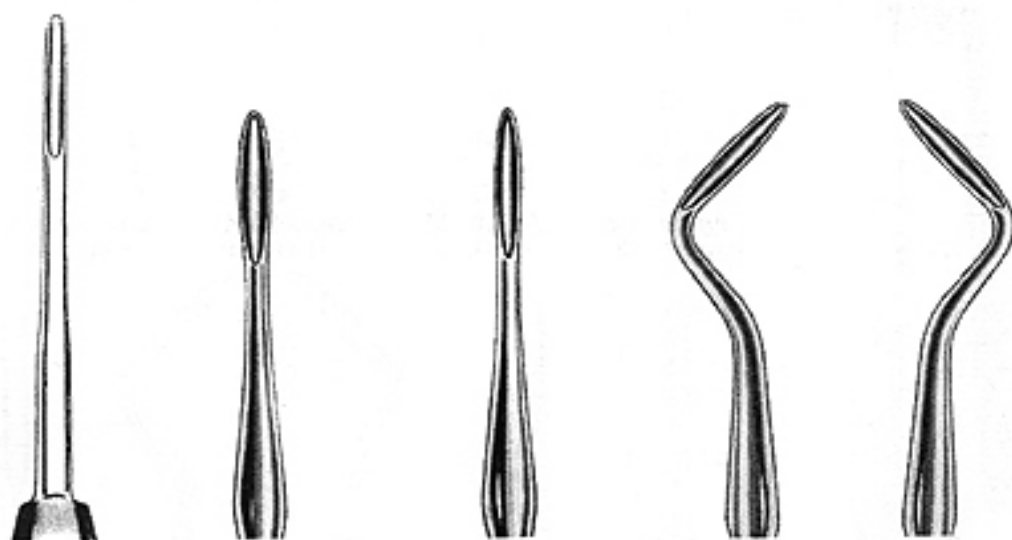

1

2

3

4

5

2 mm

4.5mm

3mm

3mm

3mm

Hylin

01-111-01

01-111-02

01-111-03

01-111-04

01-111-05

ROOT ELEVATORS
WURZELHEBER
ELEVADORES PARA RAICES

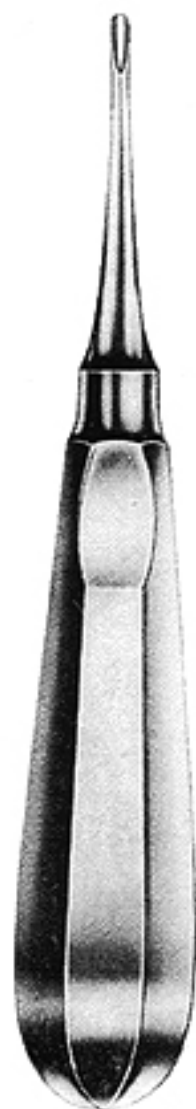
1
01-112-01
Apical 301

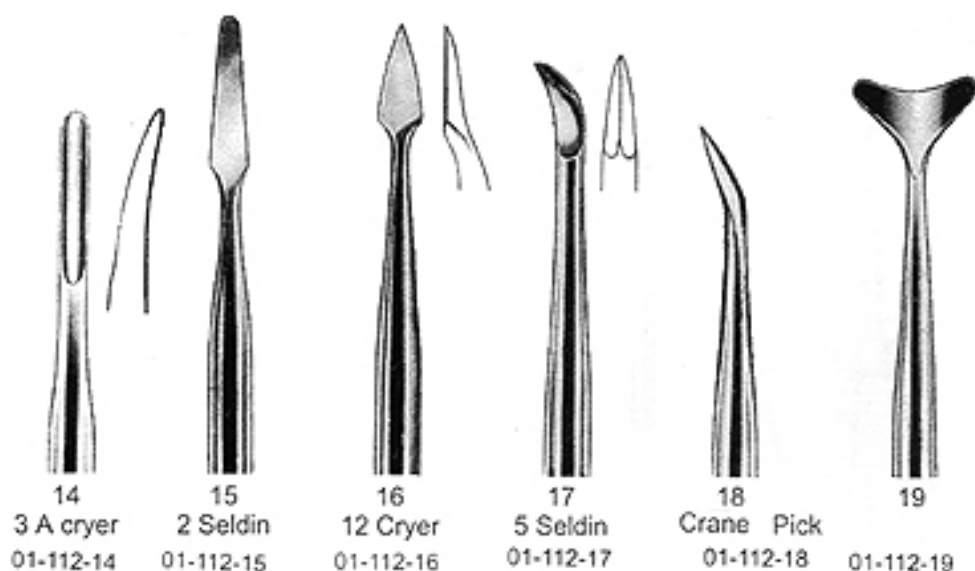

14
3 A cryer
01-112-14

15
2 Seldin
01-112-15

16
12 Cryer
01-112-16

17
5 Seldin
01-112-17

18
Crane Pick
01-112-18

19

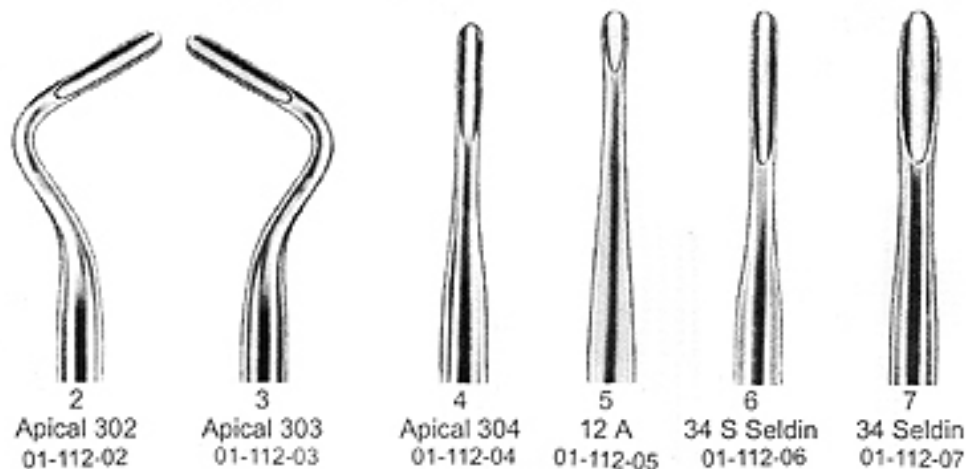

2
Apical 302
01-112-02

3
Apical 303
01-112-03

4
Apical 304
01-112-04

5
12 A
01-112-05

6
34 S Seldin
01-112-06

7
34 Seldin
01-112-07

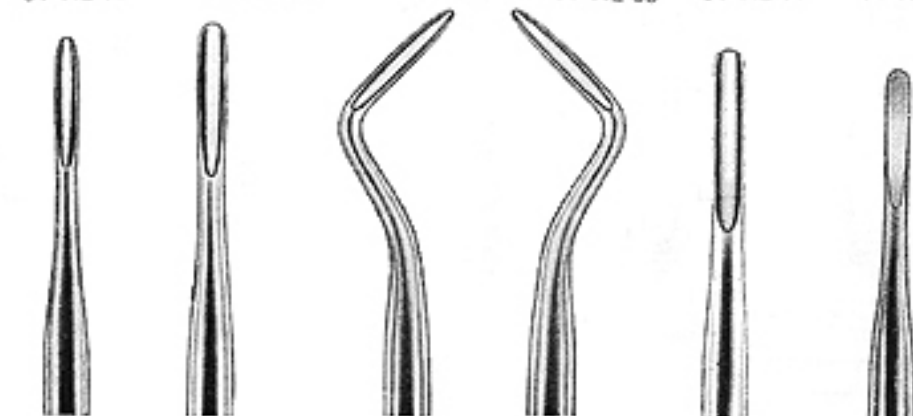

8
01-112-08

9
Flohr
01-112-09

10
Flohr
01-112-10

11
Flohr
01-112-11

12
3 Seldin
01-112-12

13
01-112-13



ROOT ELEVATORS
WURZELHEBER
ELEVADORES PARA RAICES

01



1
01-113-01
Flohr



8
Heidbrink
01-113-08



9
Heidbrink
01-113-09



10
Heidbrink
01-113-10



11
01-113-11



12
01-113-12



2
Flohr
01-113-02



3
Flohr
01-113-03



4
Flohr
01-113-04

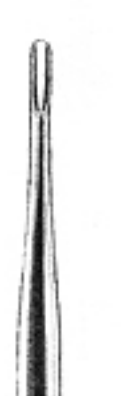

5
Flohr
01-113-05



6
Friedman
01-113-06



14
01-113-14



15
01-113-15



16
01-113-16



17
01-113-17



18
01-113-18

ROOT ELEVATORS
WURZELHEBER
ELEVADORES PARA RAICES



ARAIN

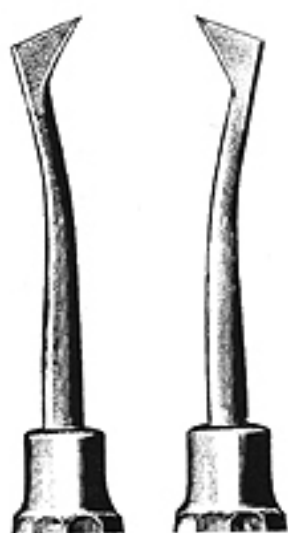

23

24

— Cryer —

01-114-23 01-114-24



81

01-114-81

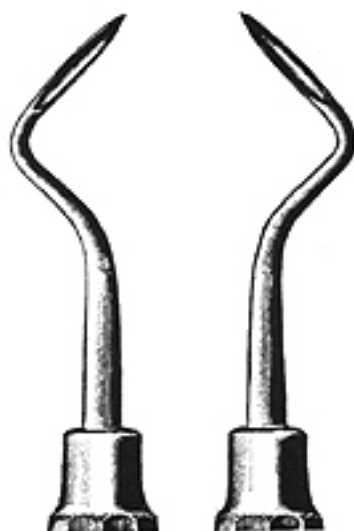

4

5

— Apical —

01-114-04 01-114-05



6

01-114-06



81

01-114-00



ROOT ELEVATORS
WURZELHEBER
ELEVADORES PARA RAICES

01

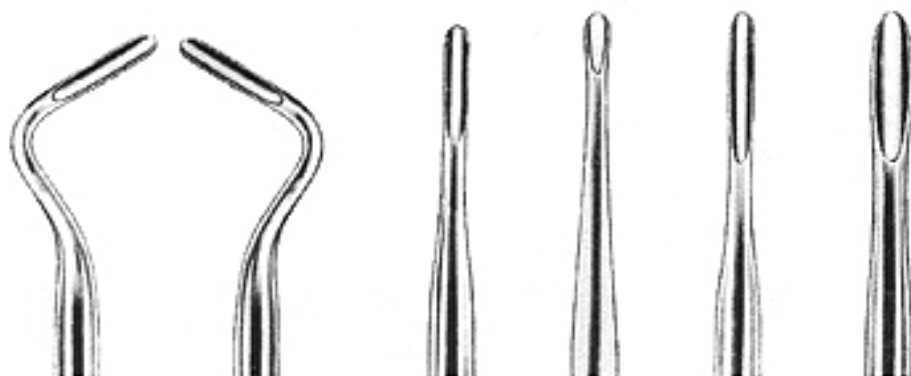

2
Apical 302
01-115-02

3
Apical 303
01-115-03

4
Apical 304
01-115-04

5
12A
01-115-05

6
34S Seldin
01-115-06

7
34 Seldin
01-115-07

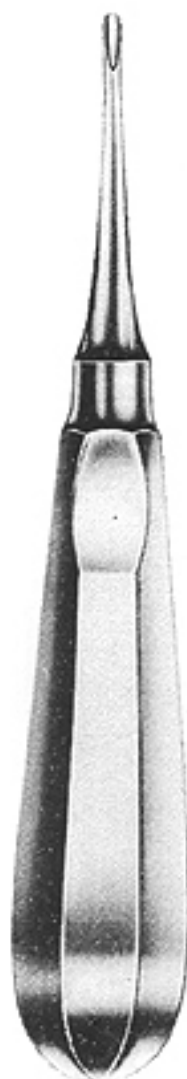

1
01-115-01
Apical 301



14
3A Cryer
01-115-14



15
2 Seldin
01-115-15



16
12 Cryer
01-115-16



17
5 Seldin
01-115-17



18
Crane Pick
01-115-18



19
01-115-19



8
01-115-08



9
Flohr
01-115-09



10
Flohr
01-115-10



11
Flohr
01-115-11



12
3 Seldin
01-115-12



13
01-115-13

ROOT ELEVATORS
WURZELHEBER
ELEVADORES PARA RAICES



ARAIN

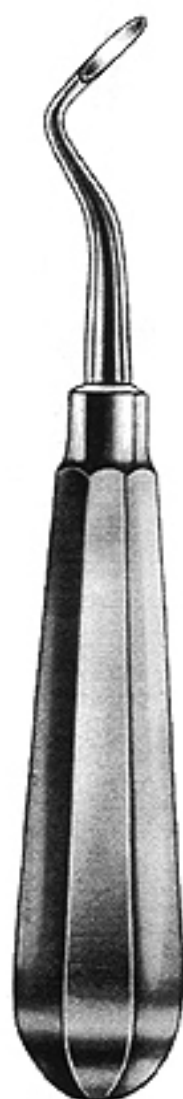

20
01-116-20



21
01-116-21

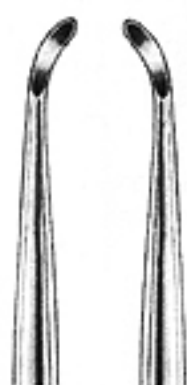

22 Miller 1
01-116-22

23 Miller 2
01-116-23



24 Miller 3
01-116-24

25 Miller 4
01-116-25

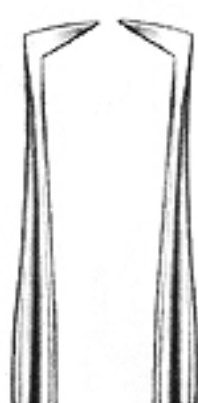

26
01-116-26

27
01-116-27

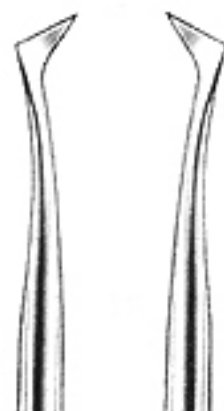

28
01-116-28

29
01-116-29

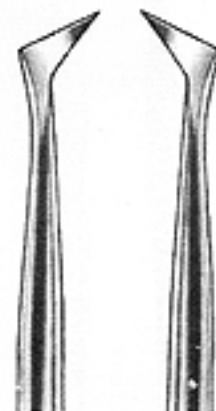

30
01-116-30

31
01-116-31



ROOT ELEVATORS
WURZELHEBER
ELEVADORES PARA RAICES

01



20
01-117-20
Flohr

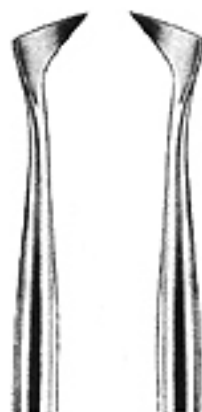

27 28
27 Cryer 28 Cryer
01-117-27 01-117-28

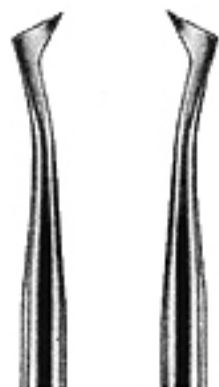

27S 28S
27S Cryer 28S Cryer
01-117-27s 01-117-28s



29 30
344 345
01-117-29 01-117-30

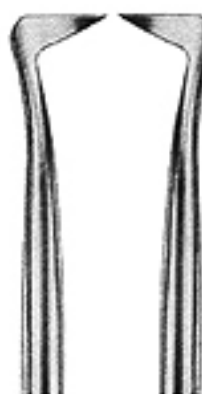

21 22
1L Seldin 1R Seldin
01-117-21 01-117-22

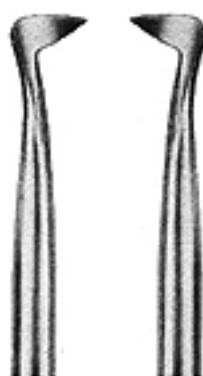

23 24
4L Seldin 4R Seldin
01-117-23 01-117-24

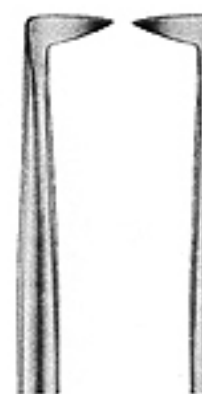

25 26
01-117-25 01-117-26



31 32
01-117-31 01-117-32



33 34
Miller 1 Miller 2
01-117-33 01-117-34



35 36
Miller 3 Miller 4
01-117-35 01-117-36

ROOT ELEVATORS
WURZELHEBER
ELEVADORES PARA RAICES



ARAIN



01-168-00



1 2
01-168-01 01-168-02



01-169-00



1
01-169-01



2
01-169-02



3
01-169-03



1
01-170-01



2
01-170-02



01-170-00



ROOT ELEVATORS
WURZELHEBER
ELEVADORES PARA RAICES

01



01-171-00
Schlemmer
1-2



1
01-171-01



2
01-171-02



1
01-172-01



2
01-172-02



3
01-172-03



01-172-00
Thomson
1-6



4
01-172-04



5
01-172-05



6
01-172-06

ROOT ELEVATORS
WURZELHEBER
ELEVADORES PARA RAICES



ARAIN



1
01-223-01
Chompret



2
01-223-02



3
01-223-03



4
01-223-04



1
01-224-01
Heidbrink



2
01-224-02



3
01-224-03
Heidbrink



1
01-225-01



2
01-225-02



3
01-225-03



ROOT ELEVATORS
WURZELHEBER
ELEVADORES PARA RAICES

01

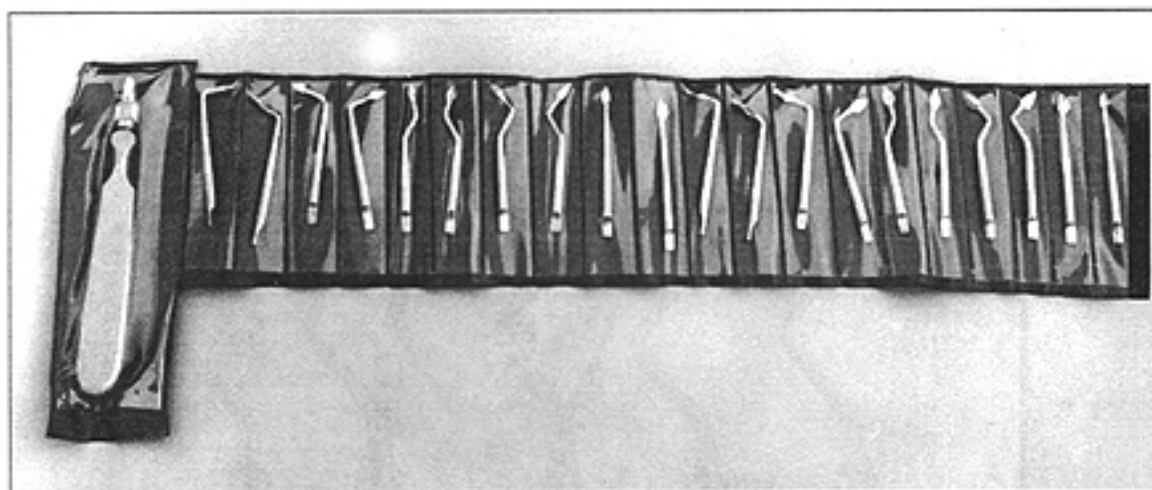

01-226-00
Elevators set with 20 detachable points

ROOT ELEVATORS
WURZELHEBER
ELEVADORES PARA RAICES



ARAIN



1
01-277-00
Heidbrink



1
01-277-01



2
01-277-02



3
01-277-03



1
01-278-00
Heidbrink



1
01-278-01



2
01-278-02



3
01-278-03



4
01-278-04



5
01-278-05



6
01-278-06

Department

02

TWEEZER
ZHAN PINZETTEN
PINZAS

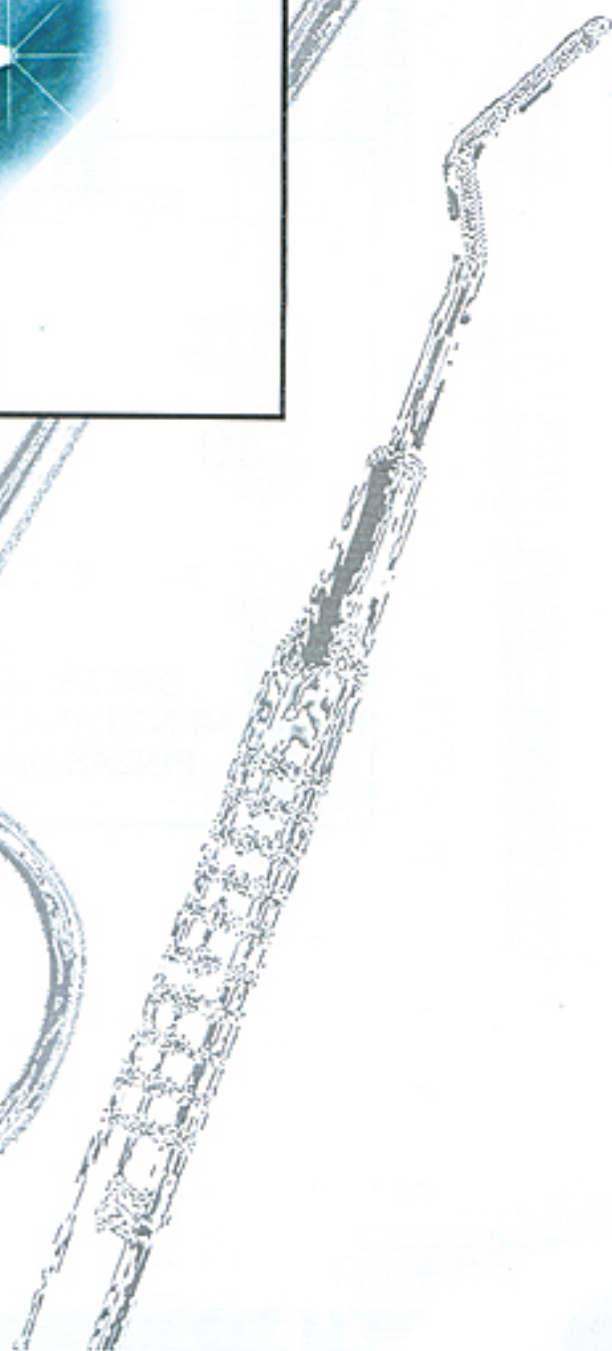
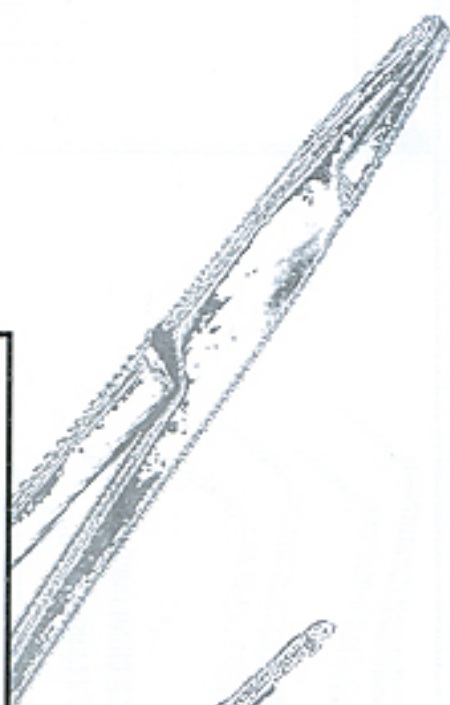
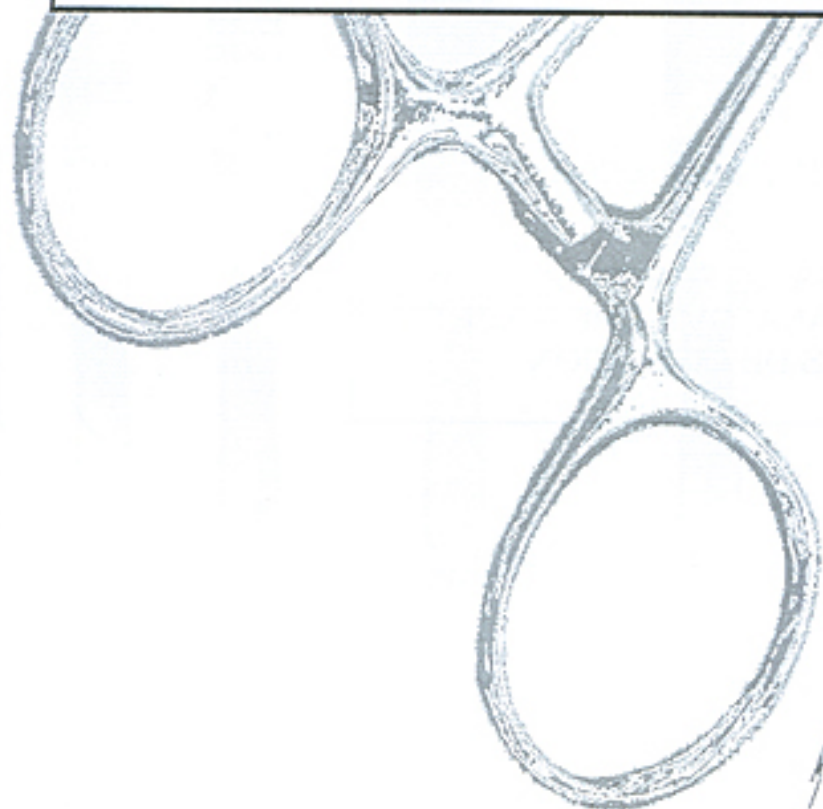
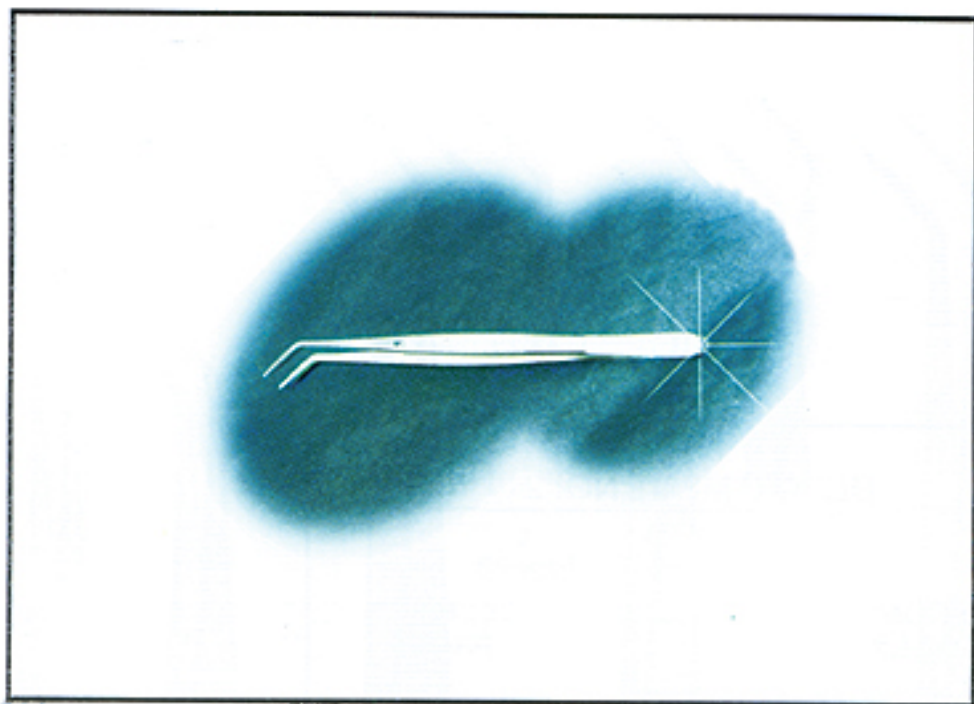

DEPARTMENT NO. 2

FROM
PAGE#

19

TO
PAGE#

38

INSTRUMENTS CATEGORY

DRESSING FORCEPS
INSTRUMENTS ANATOMISCHE PINZETTEN
PINZAS DE DISECCION

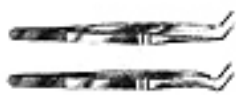

TWEEZERS
ZHAN PINZETTEN
PINZAS

02



02-001-13
13 cm

02-002-13
13 cm
Perry

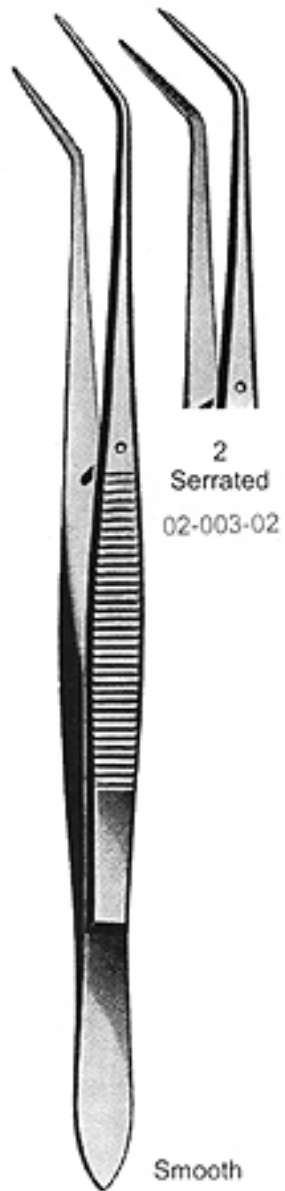

2
Serrated
02-003-02

1
02-003-16
16 cm
College

Smooth

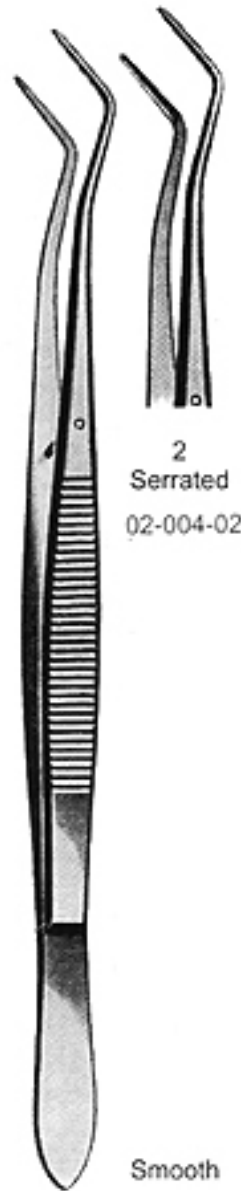

2
Serrated
02-004-02

1
02-004-16
16 cm
Meriam

Smooth

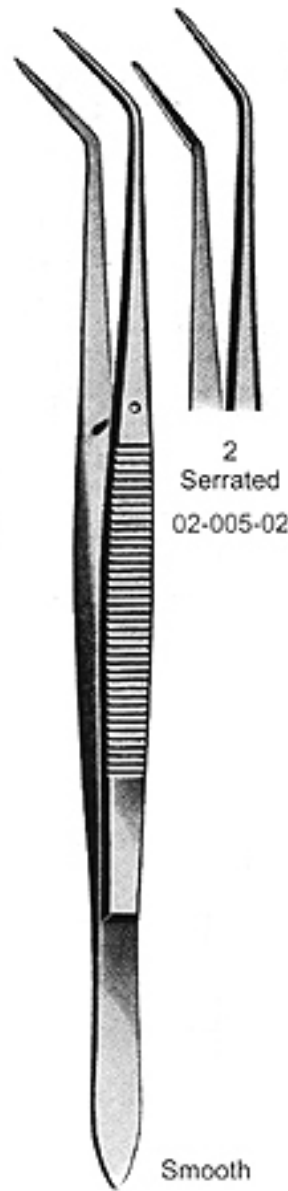

2
Serrated
02-005-02

1
02-005-16
16 cm

Smooth

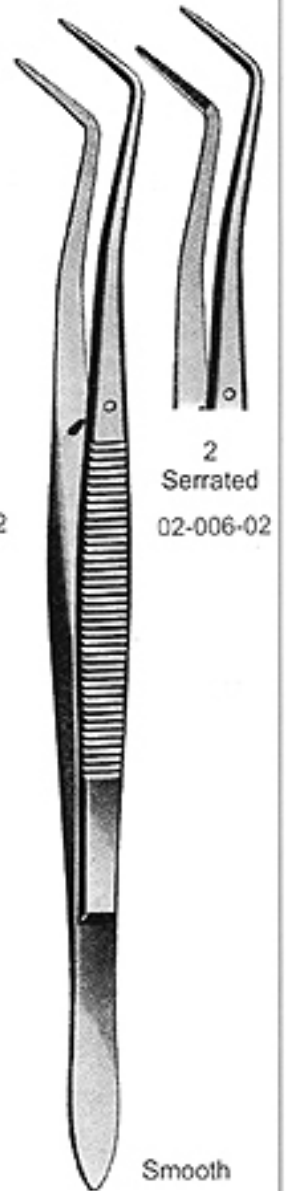

2
Serrated
02-006-02

1
02-006-16
16 cm

Smooth

Flagg

TWEEZERS
ZHAN PINZETTEN
PINZAS

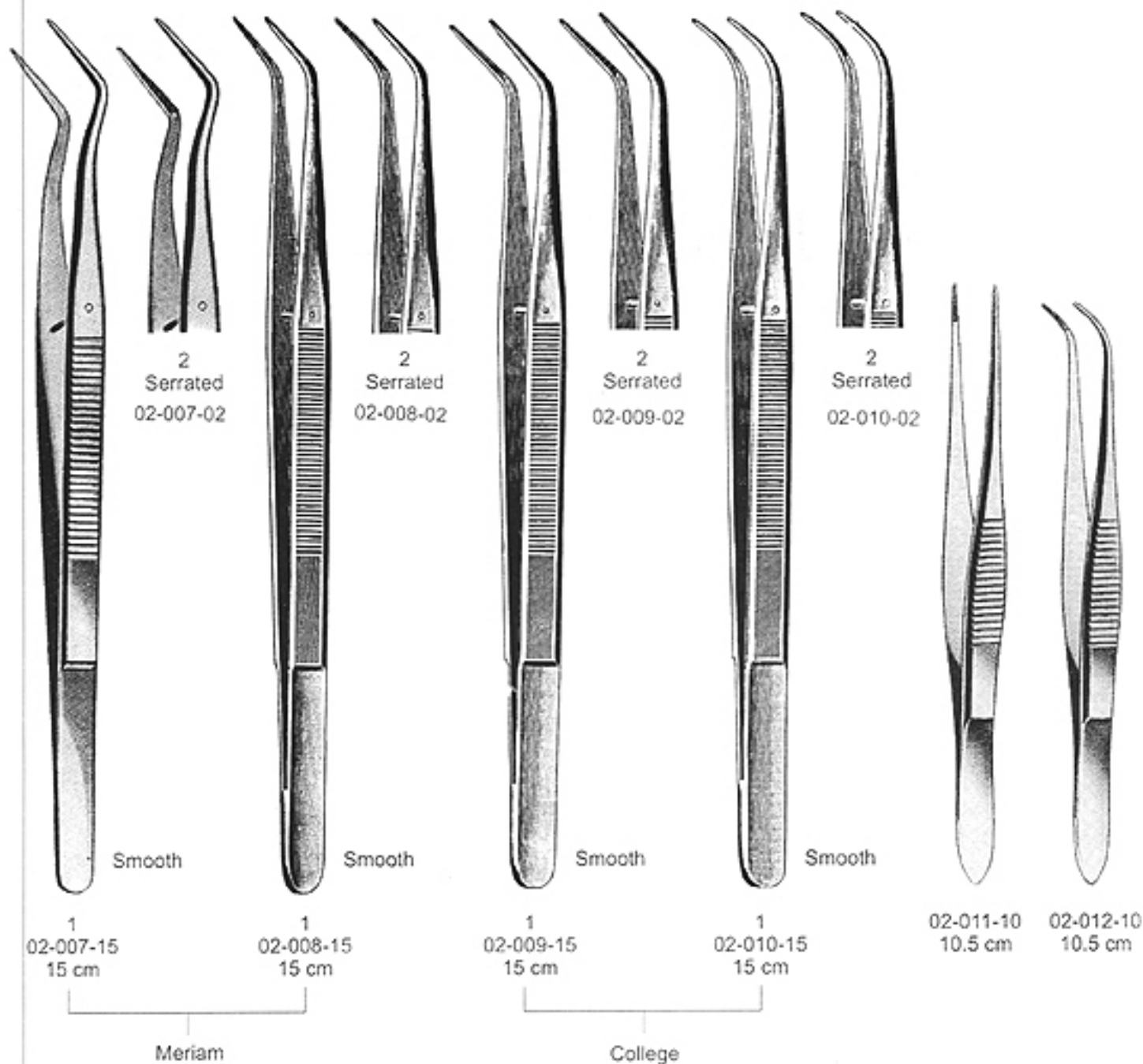

TWEEZERS
ZHAN PINZETTEN
PINZAS

02



1
02-013-00
Perry



19
02-014-00



18
02-015-00



17
02-016-00



3
02-017-00

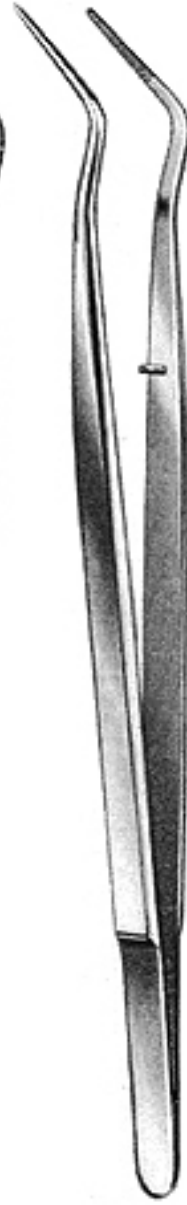

2
02-018-00
College



18L
02-019-00

TWEEZERS
ZHAN PINZETTEN
PINZAS

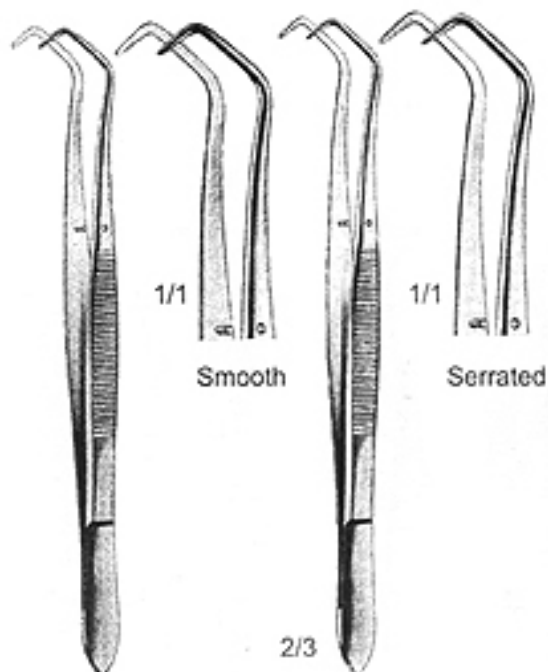
02-020-15
15 cm

02-021-15
15 cm

02-022-15
15 cm

02-023-15
15 cm



02-024-15
15 cm



02-025-15
15 cm



02-026-15
15 cm



TWEEZERS
ZHAN PINZETTEN
PINZAS

02



DRESSING AND DISSECTING FORCEPS -
 SUTURE TWEEZERS
 PINCES A DISSECTION - PINCES DE SUTURE
 PINZAS DE DISECCION - PINZAS DE SUTURA



ARAIN

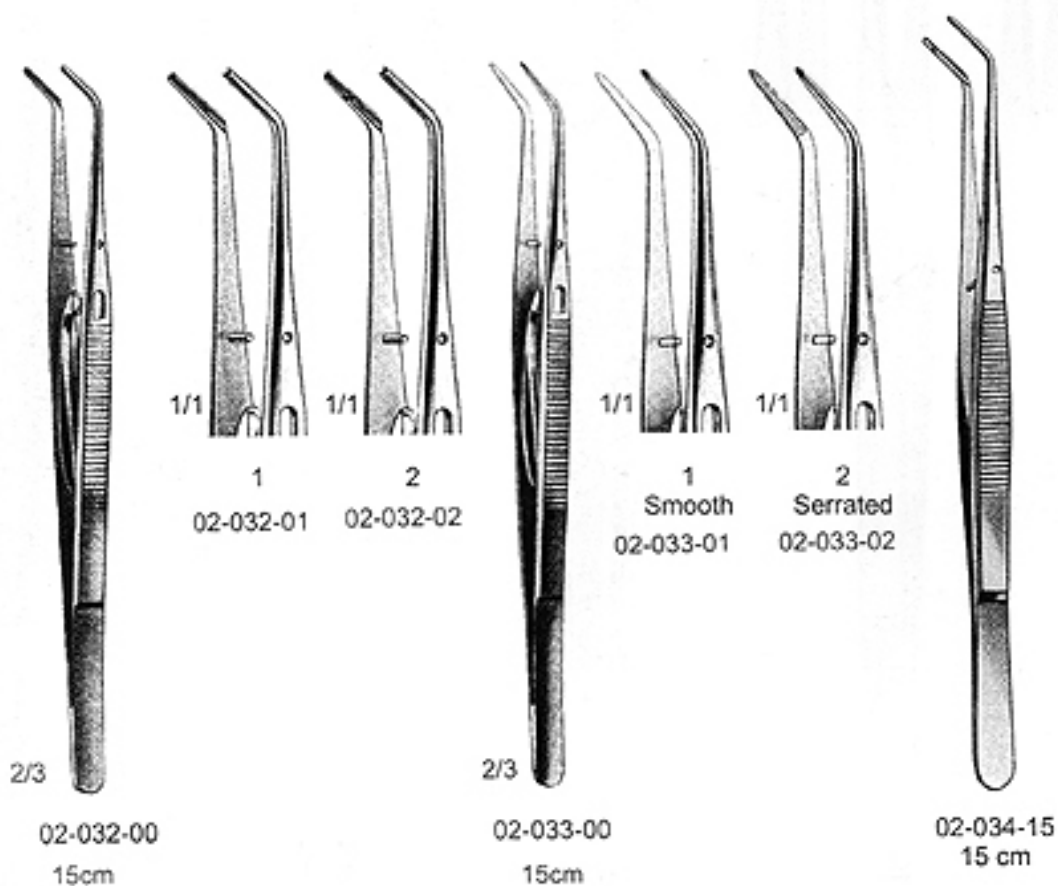
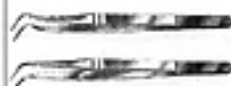



TISSUE FORCEPS
CHIRURGISCHE PINZETTEN
PRECELLES CHIRURGICALES

02



02-085-15
15.5 cm
Amsterdam

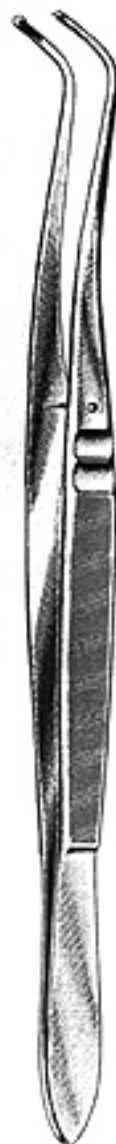

02-086-15
15.5 cm
Tiebbs



02-087-15
15 cm



02-088-15
15 cm

Gillies

2:1



02-089-13
13 cm



02-090-13
13 cm

2:1

TISSUE FORCEPS
 CHIRURGISCHE PINZETTEN
 PRECELLES CHIRURGICALES



ARAIN

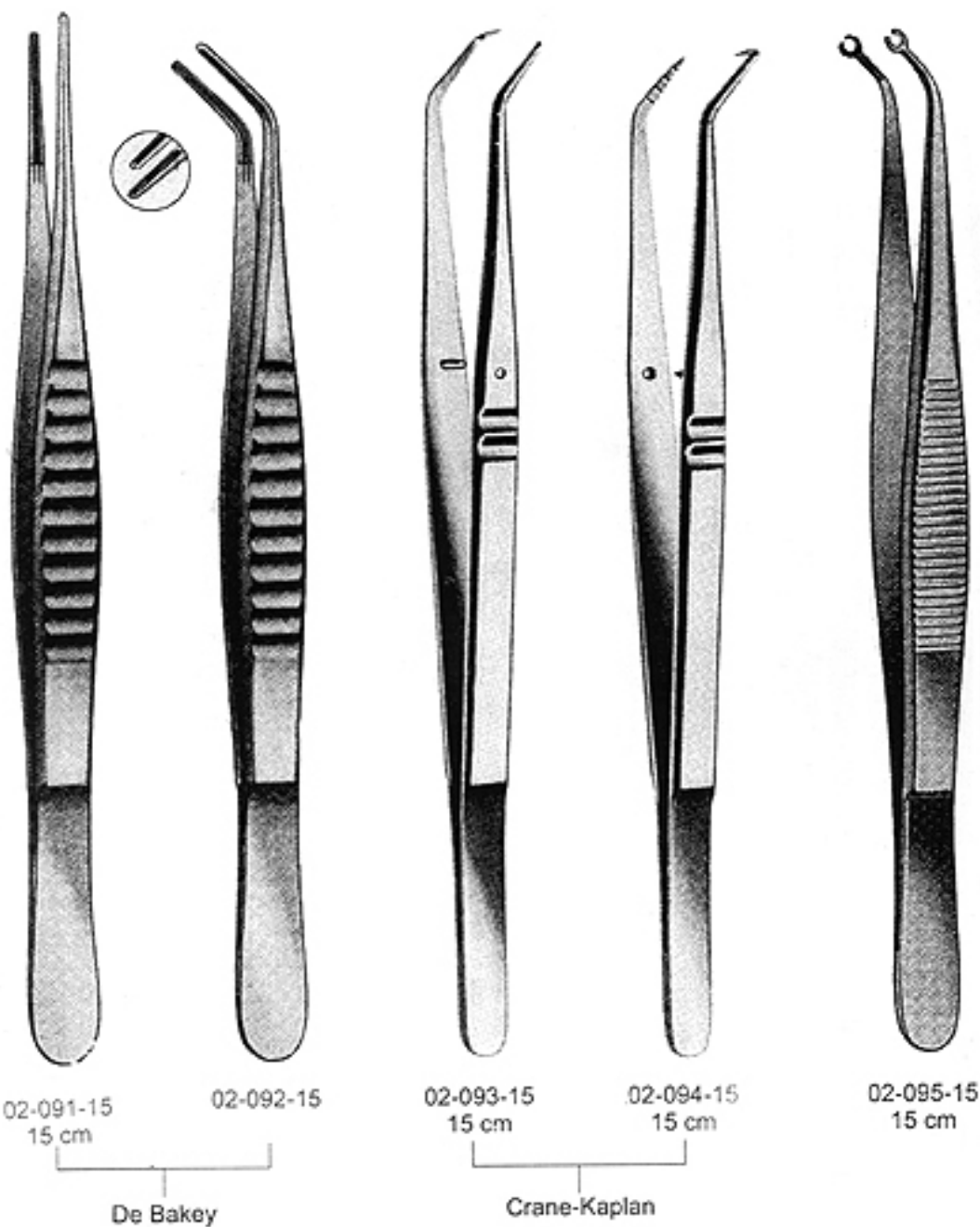



DRESSING FORCEPS
INSTRUMENTS ANATOMISCHE PINZETTEN
PINZAS DE DISECCION

02



02-146-00
Standard

1	2	3	4	5	6	7	8
11 cm	13 cm	14.5 cm	16 cm	18 cm	20 cm	25 cm	30 cm
02-146-01	02-146-02	02-146-03	02-146-04	02-146-05	02-146-06	02-146-07	02-146-08



02-147-00
Standard

1	2	3	4	5	6	7	8	9
10.5 cm	10.5 cm	13 cm	14.5 cm	16 cm	18 cm	20 cm	25 cm	30 cm
02-147-01	02-147-02	02-147-03	02-147-04	02-147-05	02-147-06	02-147-07	02-147-08	02-147-09

DRESSING FORCEPS
INSTRUMENTS ANATOMISCHE PINZETTEN
PINZAS DE DISECCION

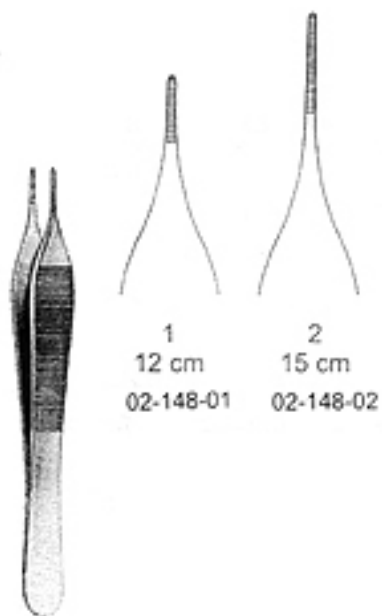
02-148-15
Adson

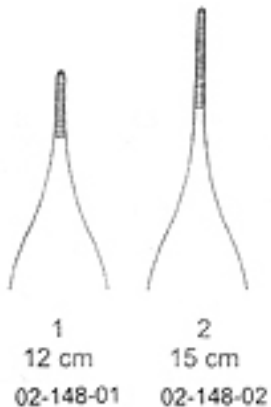

02-149-15
15 cm
McIndoe



02-149-15
Gracile

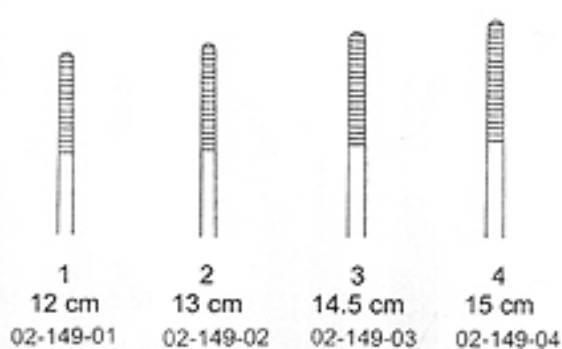

02-151-00
Standard

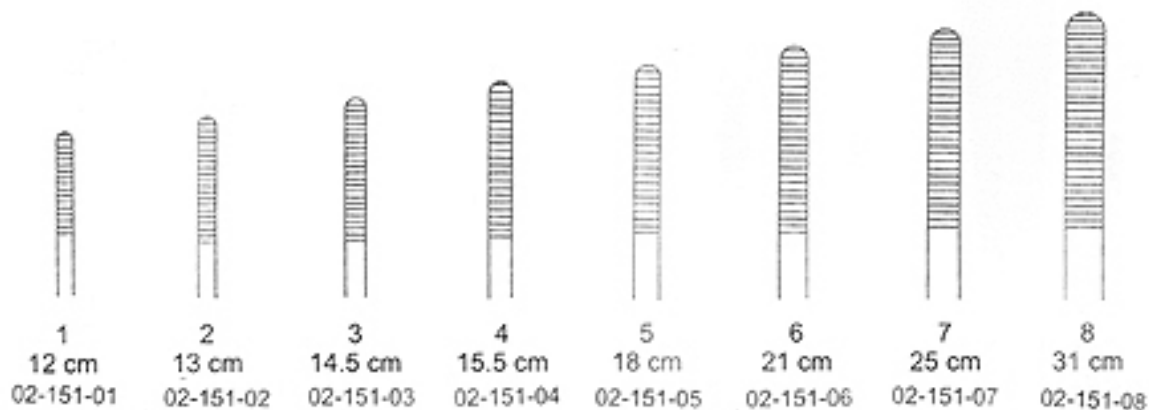



DRESSING FORCEPS
INSTRUMENTS ANATOMISCHE PINZETTEN
PINZAS DE DISECCION

02



02-152-00
Mod Martin



1
13 cm
02-152-01



2
14.5 cm
02-152-02



02-153-00
15 cm
Stille



1



02-154-00



1
13 cm
02-154-01



2
14.5 cm
02-154-02



02-155-00



1
13 cm
02-155-01



2
14.5 cm
02-155-02



3
14.5 cm
02-155-03

DRESSING FORCEPS
INSTRUMENTS ANATOMISCHE PINZETTEN
PINZAS DE DISECCION



ARAIN



02-156-00
Patts Smith



1
18 cm
02-156-01



2
21 cm
02-156-02



3
25 cm
02-156-03



02-157-18
18 cm
Gerald



02-157-18
18 cm



02-158-18
18 cm



02-159-17
17.5 cm



02-159-17
17.5 cm



02-160-17
17.5 cm



DRESSING FORCEPS
INSTRUMENTS ANATOMISCHE PINZETTEN
PINZAS DE DISECCION

02

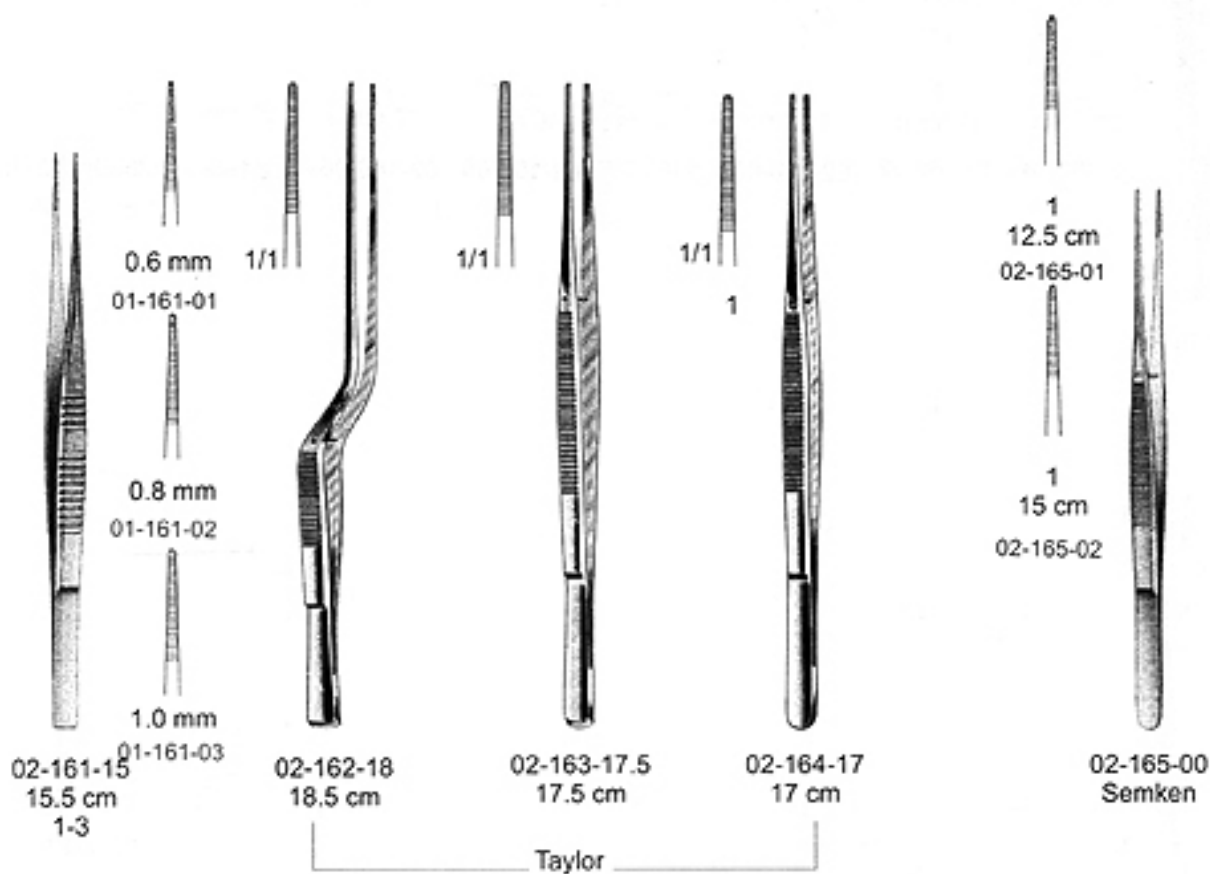

DRESSING FORCEPS
INSTRUMENTS ANATOMISCHE PINZETTEN
PINZAS DE DISECCION



1	2	3	4	5	6	7	8	9
10.5 cm	11.5 cm	13 cm	14.5 cm	16 cm	18 cm	20 cm	25 cm	30 cm
02-166-01	02-166-02	02-166-03	02-166-04	02-166-05	02-166-06	02-166-07	02-166-08	02-166-09

02-166-00
1x2 Teeth



1	2	3	4	5	6	7
11.5 cm	13 cm	14.5 cm	16 cm	18 cm	20 cm	25 cm
02-167-01	02-167-02	02-167-03	02-167-04	02-167-05	02-167-06	02-167-07

02-167-00
2x3 Teeth



DRESSING FORCEPS
INSTRUMENTS ANATOMISCHE PINZETTEN
PINZAS DE DISECCION

02



02-168-00
1x2 Teeth
1-2



1
13 cm
02-168-01



2
14 cm
02-168-02



02-169-00
1x2 Teeth
1-4



1
13 cm
02-169-01



2
14 cm
02-169-02



3
16 cm
02-169-03



4
20 cm
02-169-04



02-170-00
4x5 Teeth
1-3



1
13 cm
02-170-01



2
14.5 cm
02-170-02



3
16 cm
02-170-03



02-171-00
3x4 Teeth
1-3



1
13 cm
02-171-01



2
14.5 cm
02-171-02



3
16 cm
02-171-03

DRESSING FORCEPS
INSTRUMENTS ANATOMISCHE PINZETTEN
PINZAS DE DISECCION



02-172-00
Mod U.S.A.
1-8

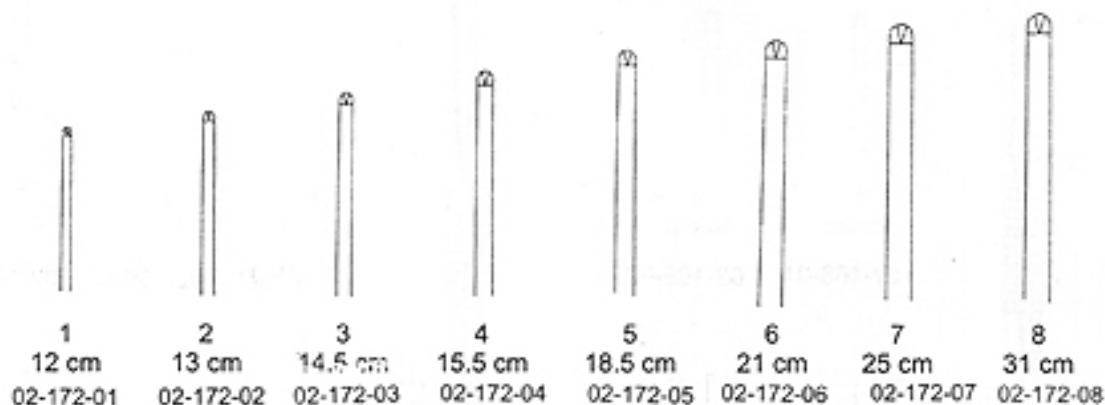

02-173-15
15 cm
Stille
1x2 Teeth



1/1



02-174-15
15 cm
Stille
2x3 Teeth



1/1



02-175-00
Mod-Martin
1x2 Teeth



1
13 cm
02-175-01



1
14.5 cm
02-175-02



TWEEZERS
ZHAN PINZETTEN
PINZAS

02



02-176-08
8 cm



02-177-09
9 cm



02-178-08
8 cm
Feilchenfeld



02-179-10
10.5 cm



02-180-10
10.5 cm

Hunter



TUNGSTEN CARBIDE INSERTS



02-231-12
12 cm
Adson



02-232-12 02-232-15
12 cm 15 cm
Semken



02-233-15
15 cm
College



02-234-15
15 cm
Meriam



02-235-15
15 cm
Potts-Smith



02-236-15
15 cm
Standard



02-237-15
15 cm
Meriam



02-238-15
15 cm
Cushing

Department

03

PERIOSTEAL ELEVATORS
RASPATORIEN UND ELEVATORIEN
PERIOSTOTOMOS

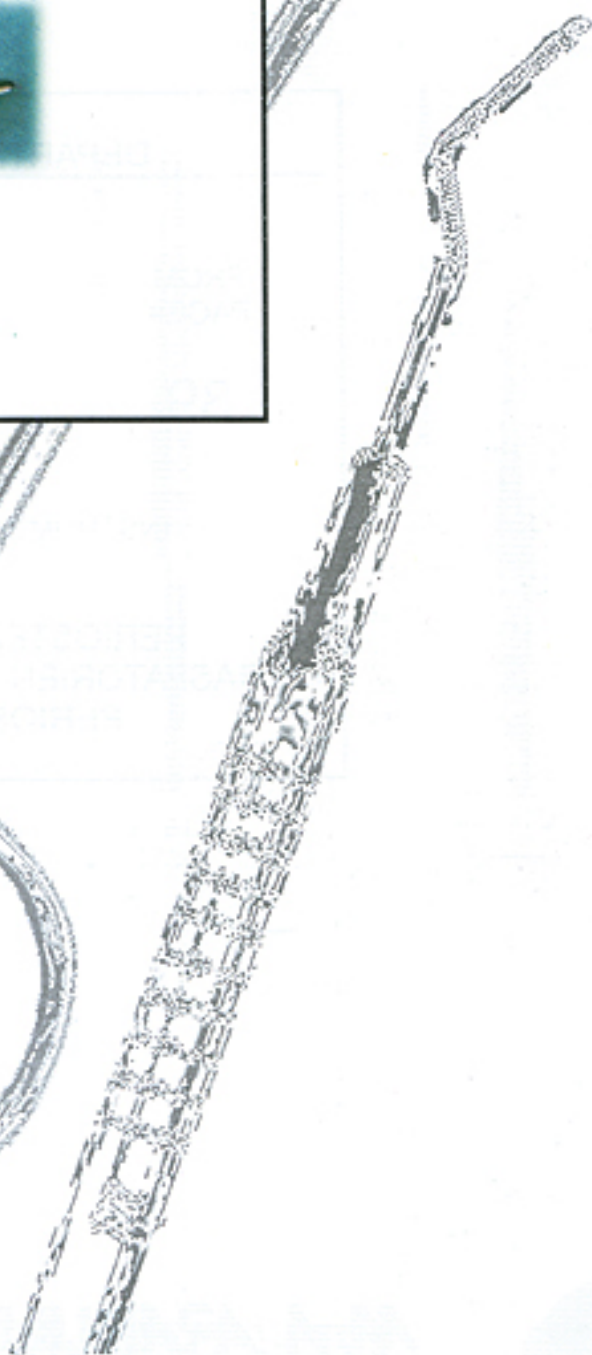
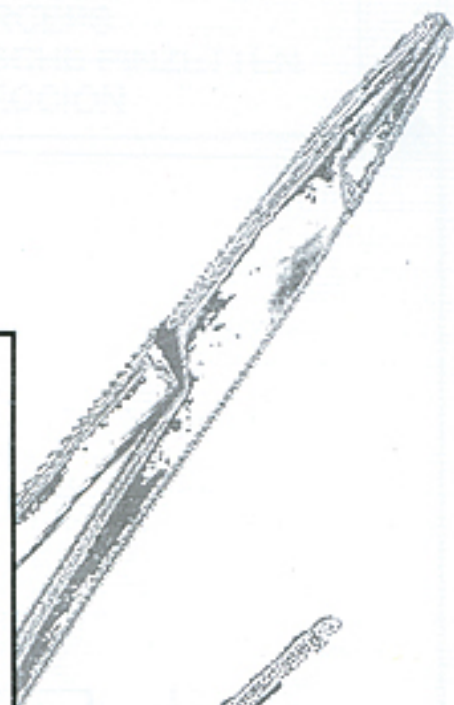
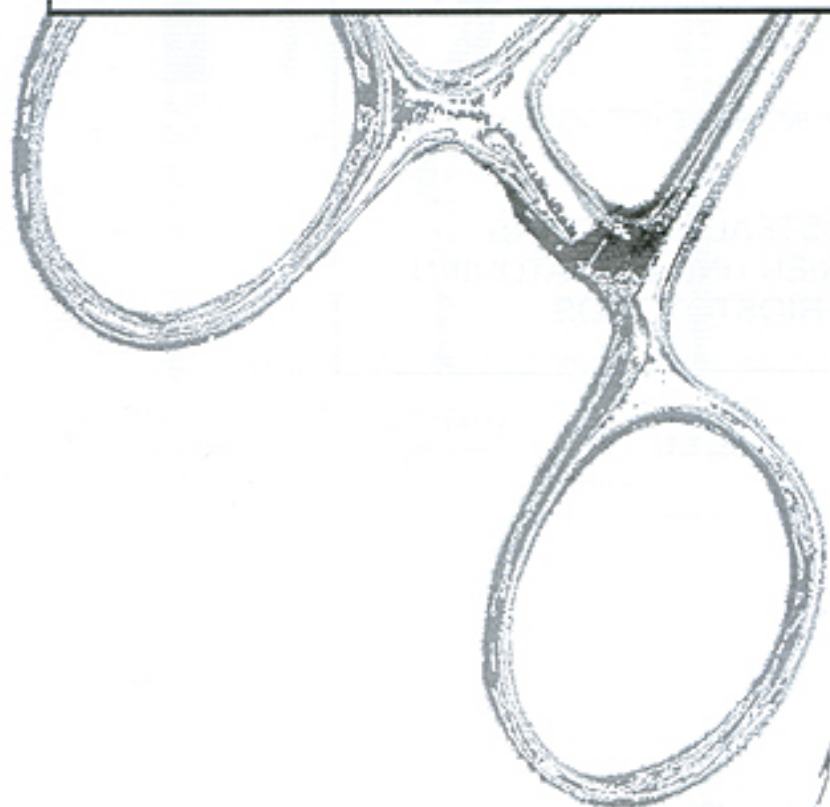
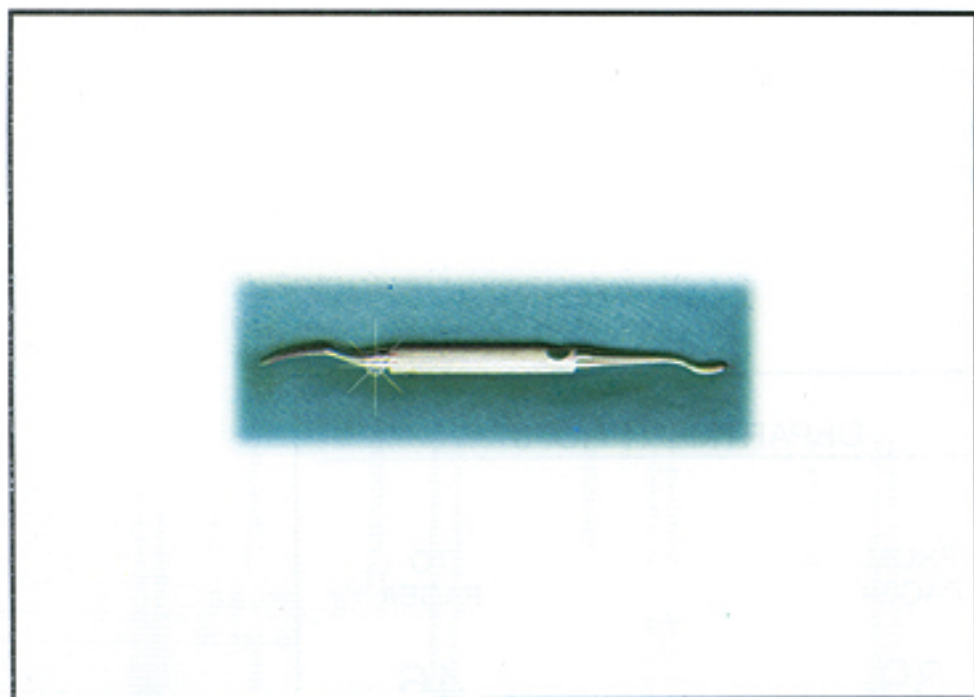

DEPARTMENT NO. 3

FROM
PAGE#

39

TO
PAGE#

46

INSTRUMENTS CATEGORY

PERIOSTEAL ELEVATORS
RASPATORIEN UND ELEVATORIEN
PERIOSTOTOMOS

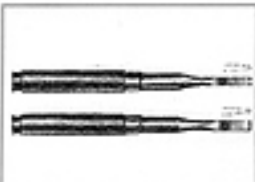

PERIOSTEAL ELEVATORS
 RASPATORIEN UND ELEVATORIEN
 PERIOSTOTOMOS

03



03-001-17
 17 cm
 Kendzia



03-002-18.5
 18.5 cm
 Freer

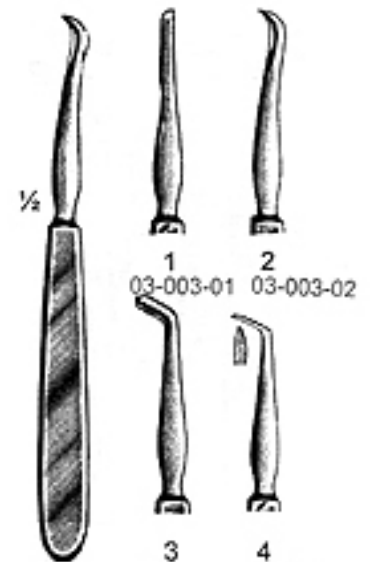

03-003-15
 15 cm
 Chompret

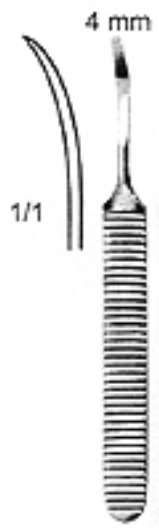

03-004-14
 14 cm



03-005-17
 17.5 cm



03-006-16
 16.5 cm



03-007-16
 16 cm

Willinger

PERIOSTEAL ELEVATORS
 RASPATORIEN UND ELEVATORIEN
 PERIOSTOTOMOS

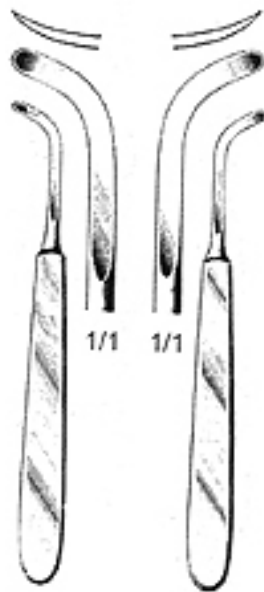
03-008-14
 14 cm
 Left

03-009-14
 14 cm
 Right



03-011-18
 18.5 cm
 Freer-Yasargil



03-012-20
 20 cm
 Sewall

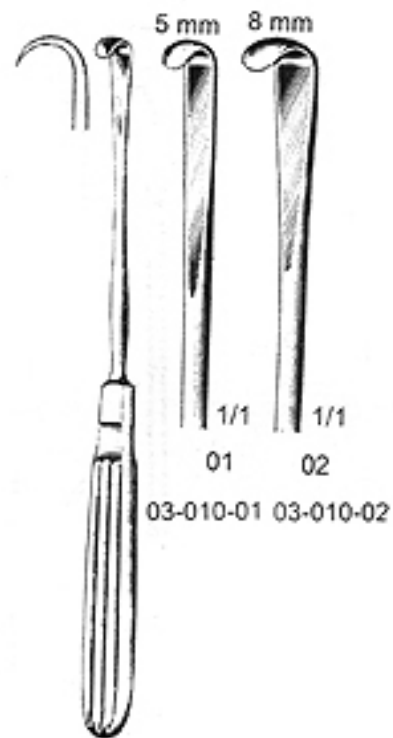

03-010-20
 20 cm

8 mm



03-013-14
 14 cm
 Trelat



PERIOSTEAL ELEVATORS
RASPATORIEN UND ELEVATORIEN
PERIOSTOTOMOS

03



03-014-18
18 cm
Molt

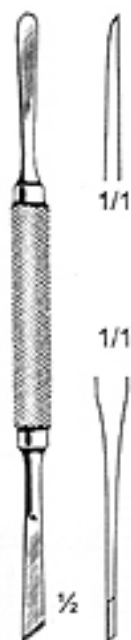

03-015-16
16.5 cm
Mead

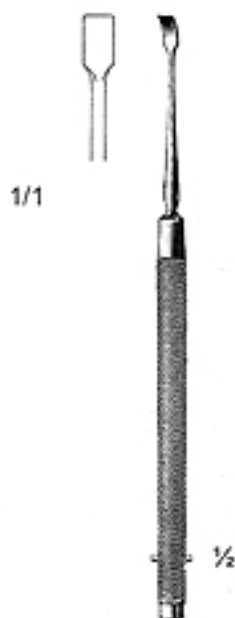

03-016-16
16 cm
Freer

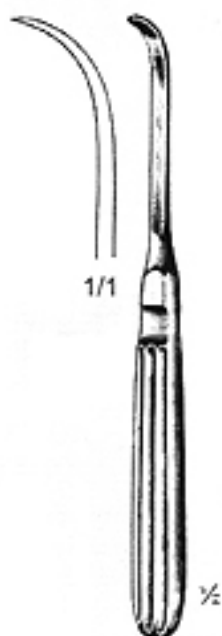

03-017-17
03-018-17 (6mm)
17 cm

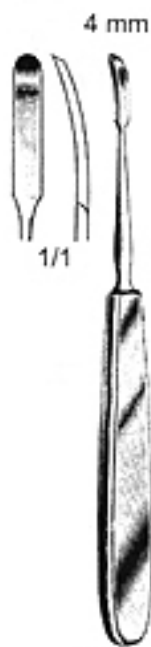

03-019-16
16 cm
Joseph



03-020-17
17 cm

CHISELS AND GOUGES
BURINS ET GOUGES
CINCELES Y GUBIAS

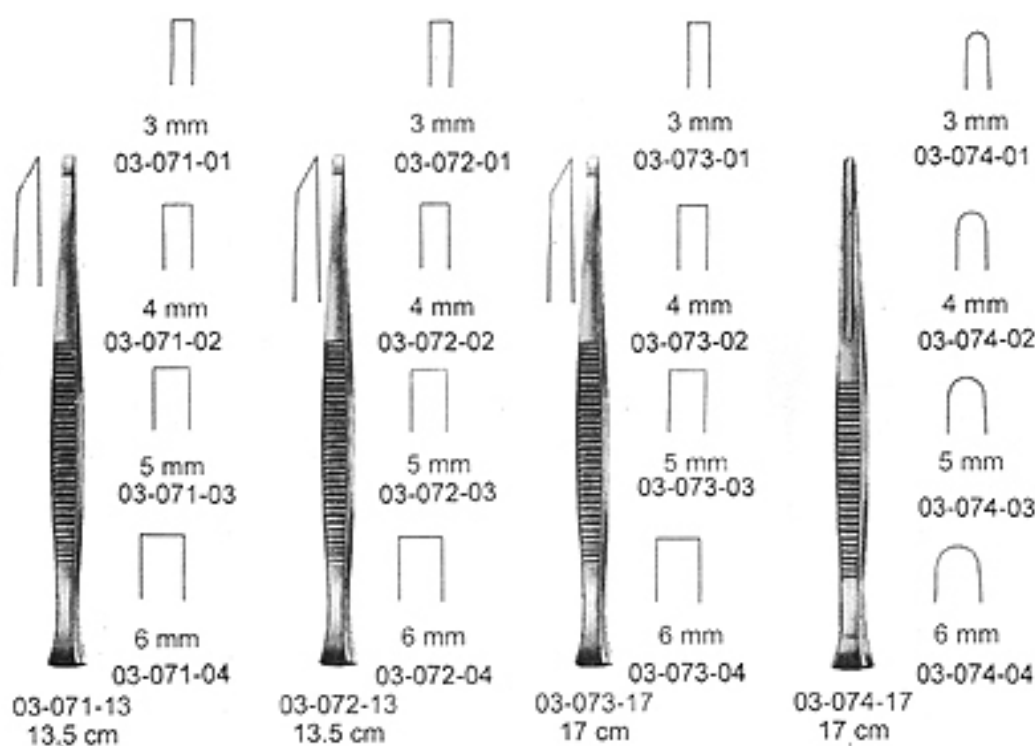
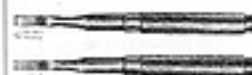
Partsch



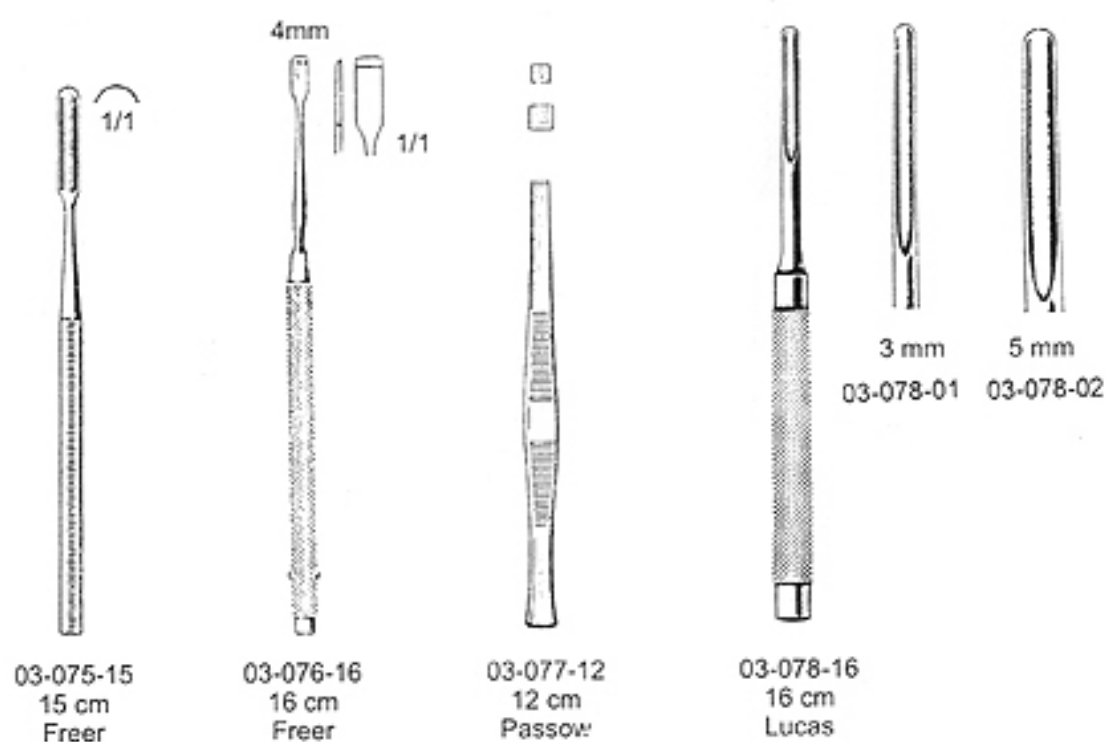

PERIODONTIA INSTRUMENTS
INSTRUMENTE FÜR DIE PARODONTOLOGIE
INSTRUMENTOS PARA PERIODONCIA

03



03-079-00 03-080-00 03-081-00 03-082-00 03-083-00 03-084-00 03-085-00 03-086-00 03-087-00 03-088-00
[Ochsenbein] Gardner [Waketfield] Buckley

BONE FILES
LIMES A OS
LIMAS PARA HUESOS



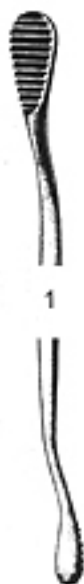

03-139-00
Miller-Colburn

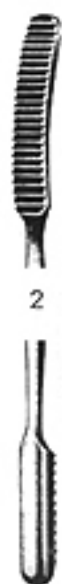

03-139-01

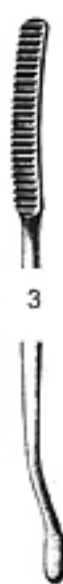

03-139-02



03-139-03

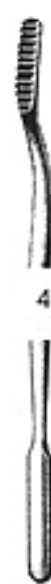

03-139-04



03-140-00

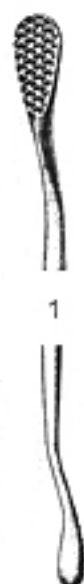

03-140-01

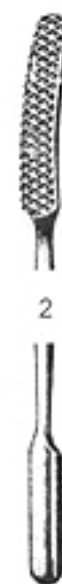

03-140-02

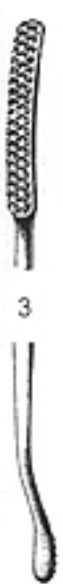

03-140-03



03-140-04

Department

04

EXTRACTING FORCEP, ENGLISH PATTERN
ZAHNANGEN, ENGLISCHE FORM
FORCEPS DE EXTRACCION, FORMA EGGLESA

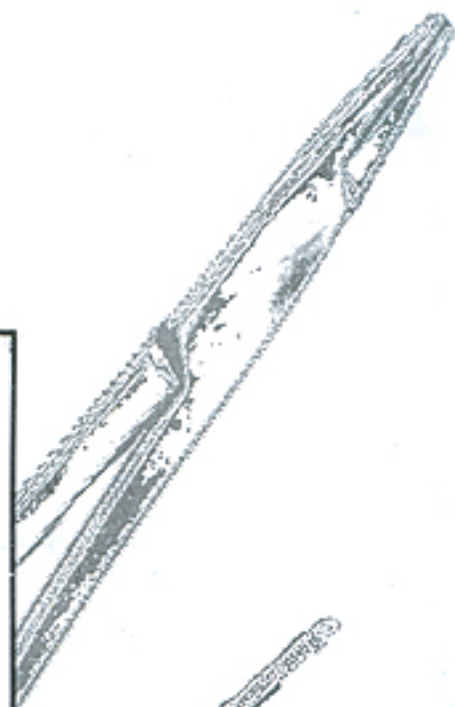
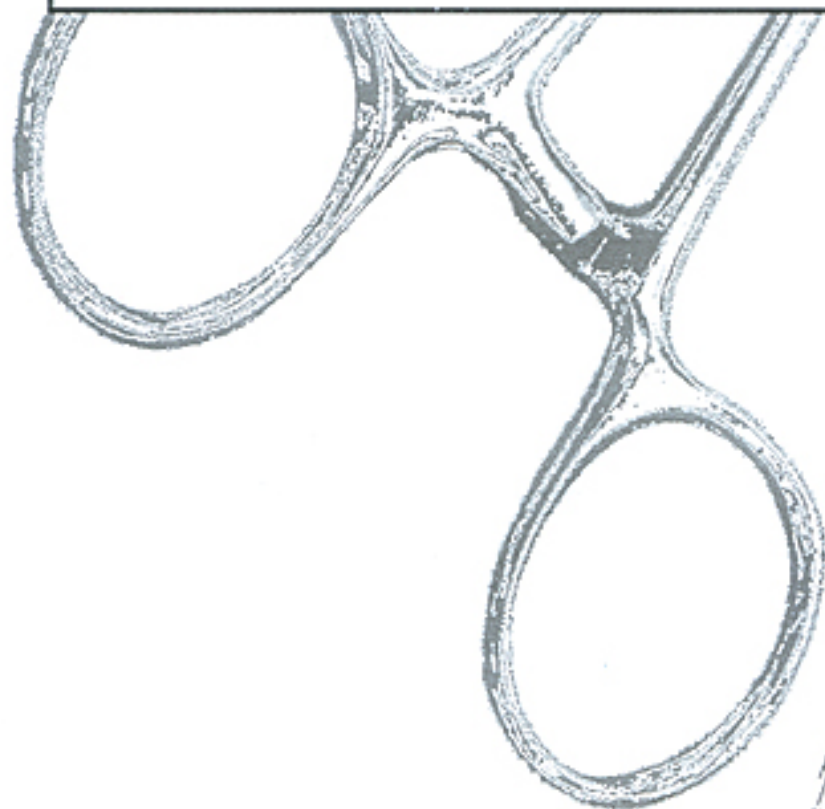

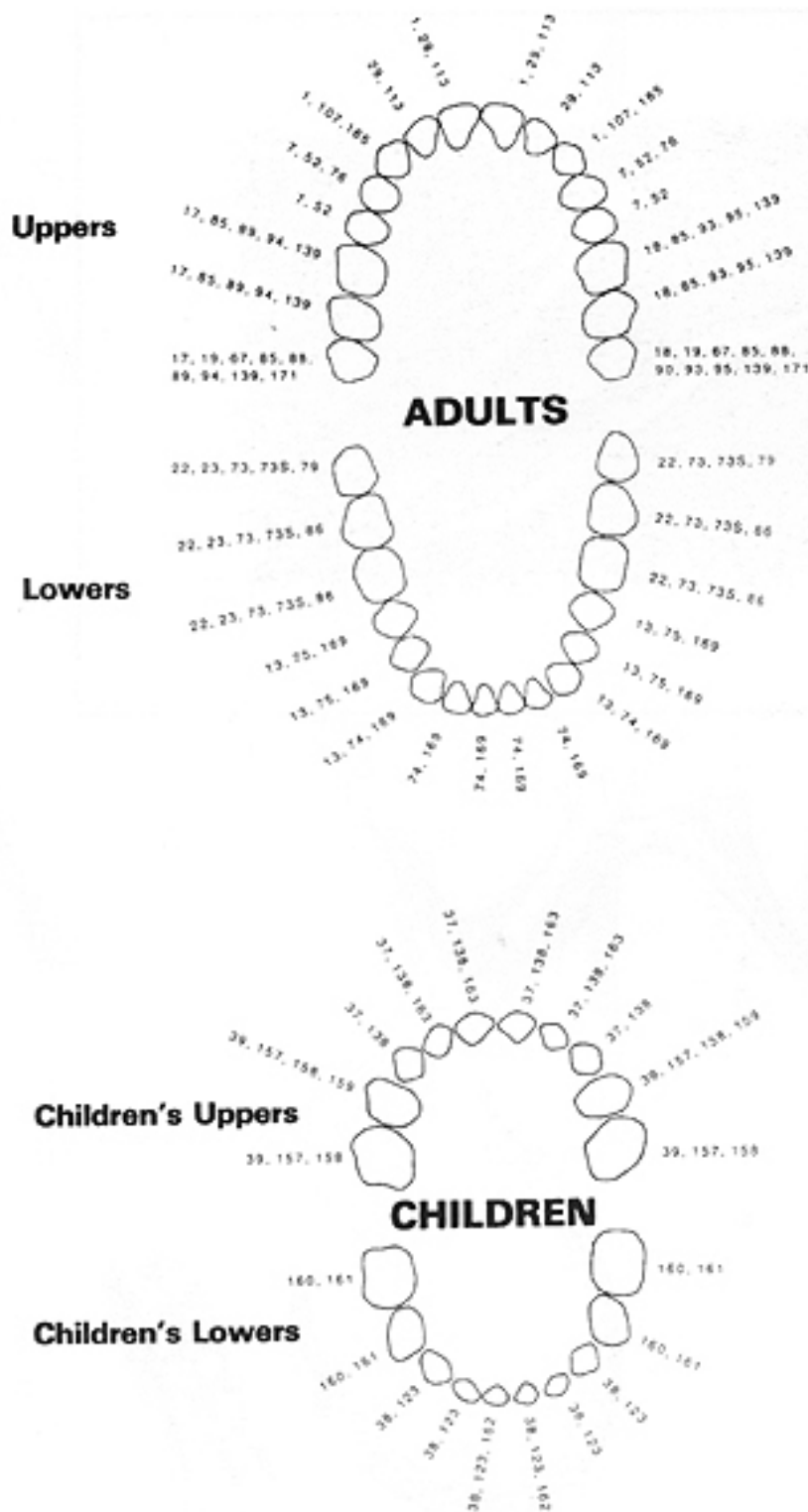

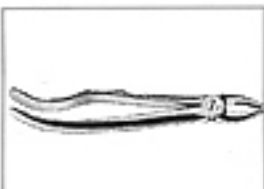

ARAIN

EXTRACTING FORCEPS, ENGLISH PATTERN
ZAHNZANGEN, ENGLISCHE FORM
FORCEPS DE EXTRACCION, FORMA ENGLESA

04

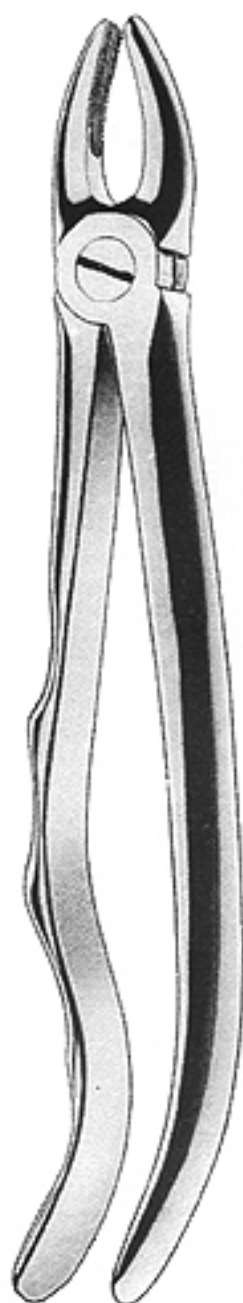

1
04-001-00



2
04-002-00



2 B
04-003-00



7
04-004-00



27
04-005-00



27 B
04-006-00



M. A. ARAIN & BROTHERS (PVT.) LTD.

49

EXTRACTING FORCEPS, ENGLISH PATTERN
ZAHNZANGEN, ENGLISCHE FORM
FORCEPS DE EXTRACCION, FORMA ENGLESA



ARAIN

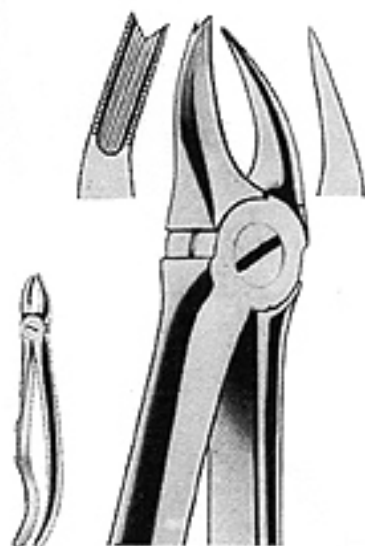

66 R
04-007-00

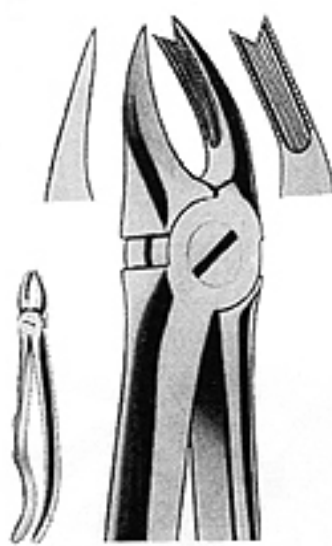

66 L
04-008-00



ARAIN

EXTRACTING FORCEPS, ENGLISH PATTERN
ZAHNZANGEN, ENGLISCHE FORM
FORCEPS DE EXTRACCION, FORMA ENGLESA

04

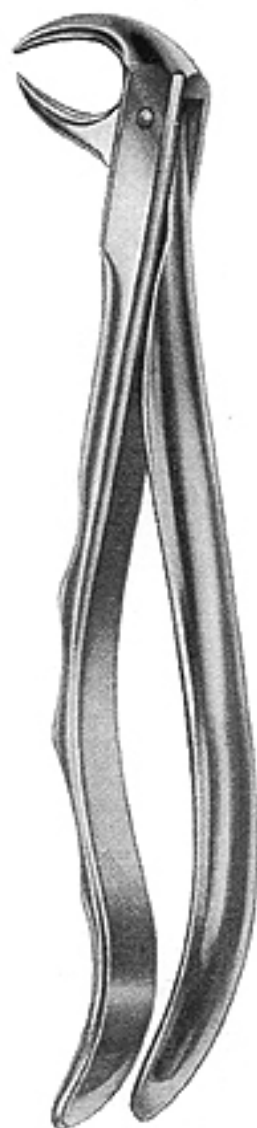

86
04-010-00



13
04-011-00



28
04-012-00



23 B
04-013-00

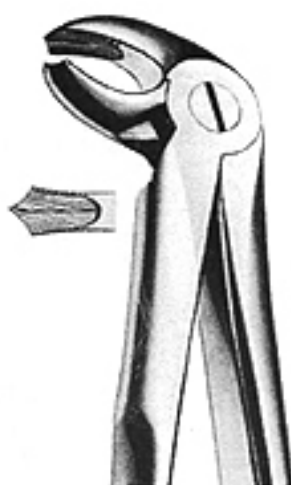

22
04-014-00

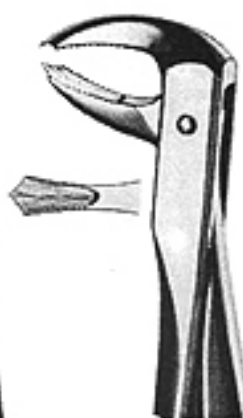

78
04-015-00



79
04-016-00

M. A. ARAIN & BROTHERS (PVT.) LTD.

51

EXTRACTING FORCEPS, ENGLISH PATTERN
 ZAHNZANGEN, ENGLISCHE FORM
 FORCEPS DE EXTRACCION, FORMA ENGLESA



ARAIN



97
04-017-00



59
04-018-00



74
04-019-00

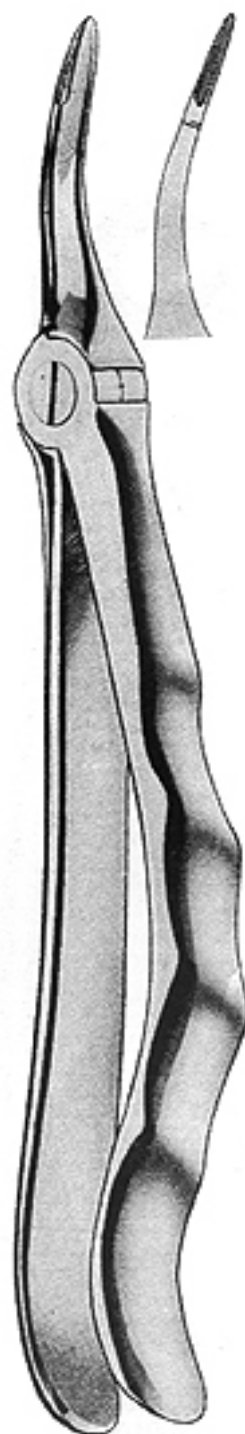

49
04-023-00

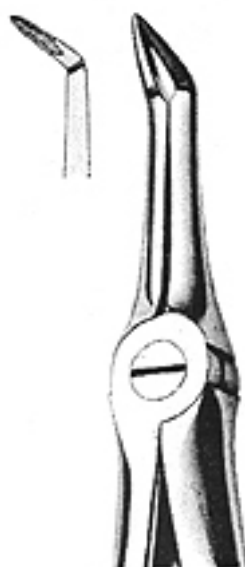

46
04-020-00



33
04-021-00



33 A
04-022-00

M.A. ARAIN & BROTHERS (PVT.) LTD.



ARAIN

EXTRACTING FORCEPS, ENGLISH PATTERN
ZAHNZANGEN, ENGLISCHE FORM
FORCEPS DE EXTRACCION, FORMA ENGLESA

04



1
04-024-00



1
04-025-00

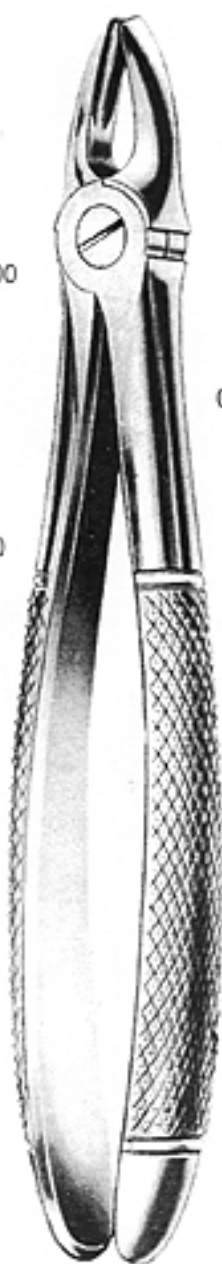

1
04-024-00



2
04-026-00

2
04-027-00

2
04-026-00



3
04-028-00

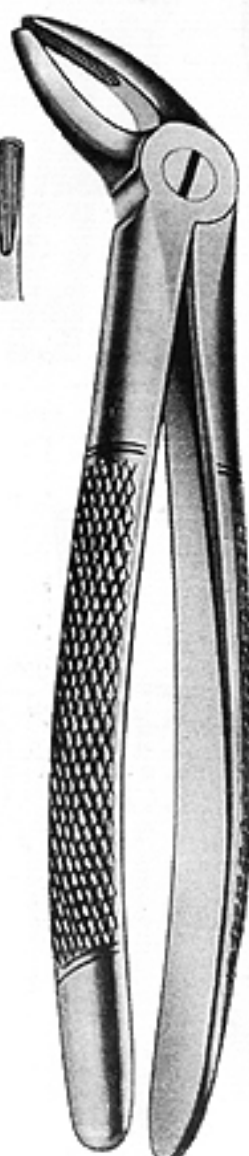

4
04-029-00

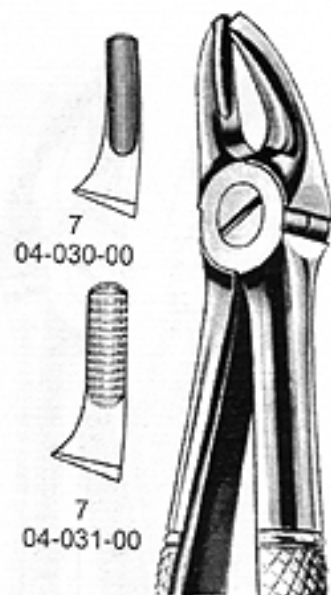

7
04-030-00

7
04-031-00

7
04-030-00



8
04-032-00

EXTRACTING FORCEPS, ENGLISH PATTERN
 ZAHNZANGEN, ENGLISCHE FORM
 FORCEPS DE EXTRACCION, FORMA ENGLESA

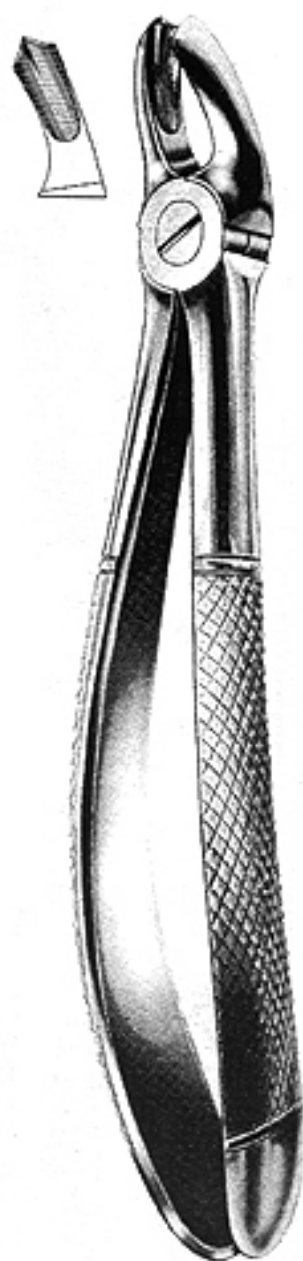

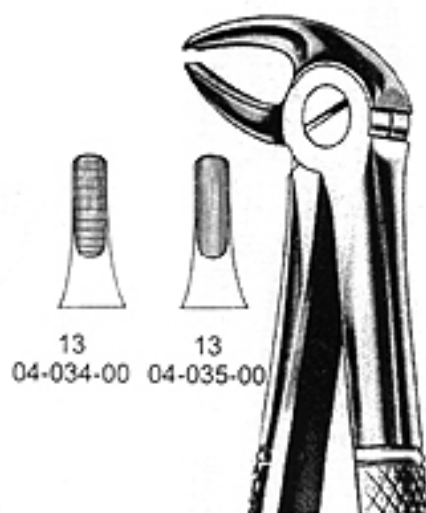

17
04-036-00
Right

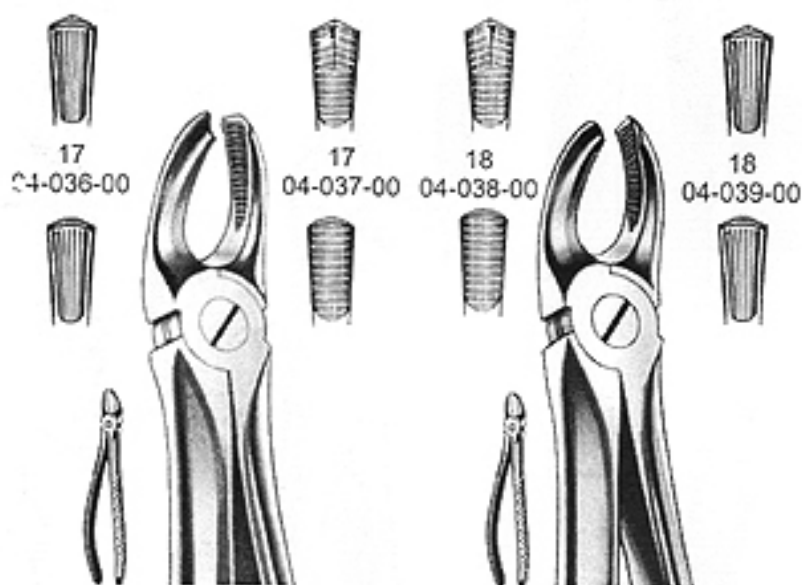

13 13
04-034-00 04-035-00

13
04-034-00



17
04-036-00

17
04-037-00

18
04-038-00

18
04-039-00

17
04-036-00
Right

18
04-038-00
Left



ARAIN

EXTRACTING FORCEPS, ENGLISH PATTERN
ZAHNZANGEN, ENGLISCHE FORM
FORCEPS DE EXTRACCION, FORMA ENGLESA

04



20
04-040-00
Molaron

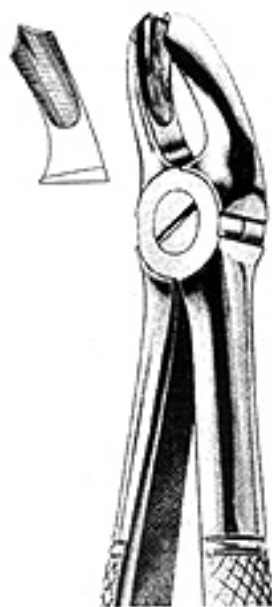

18 A
04-041-00

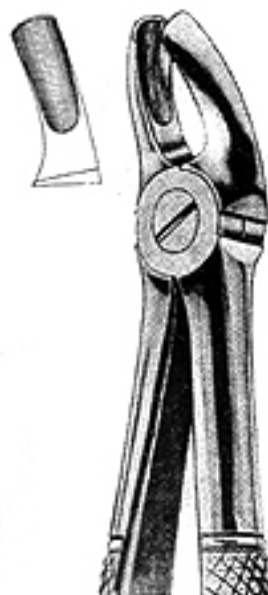

18 B
04-042-00



19
04-043-00



21
04-044-00



22
04-045-00



22 G
04-046-00

M. A. ARAIN & BROTHERS (PVT.) LTD.

55

EXTRACTING FORCEPS, ENGLISH PATTERN
 ZAHNZANGEN, ENGLISCHE FORM
 FORCEPS DE EXTRACCION, FORMA ENGLESA



ARAIN

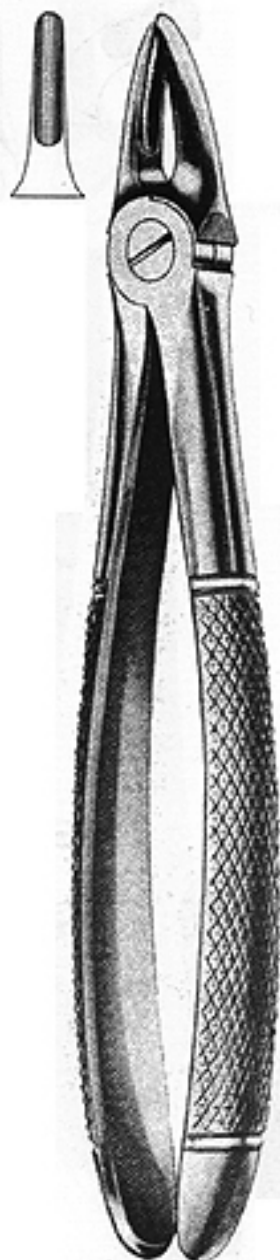

29
04-047-00



29 S
04-048-00

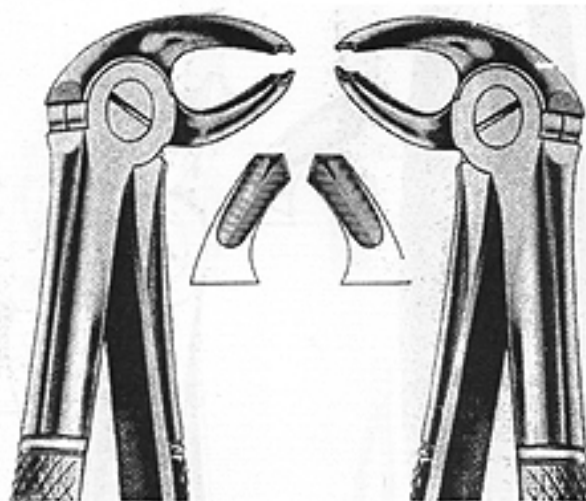

23
04-049-00
Right

24
04-050-00
Left



ARAIN

EXTRACTING FORCEPS, ENGLISH PATTERN
ZAHNZANGEN, ENGLISCHE FORM
FORCEPS DE EXTRACCION, FORMA ENGLESA

04



30
04-051-00

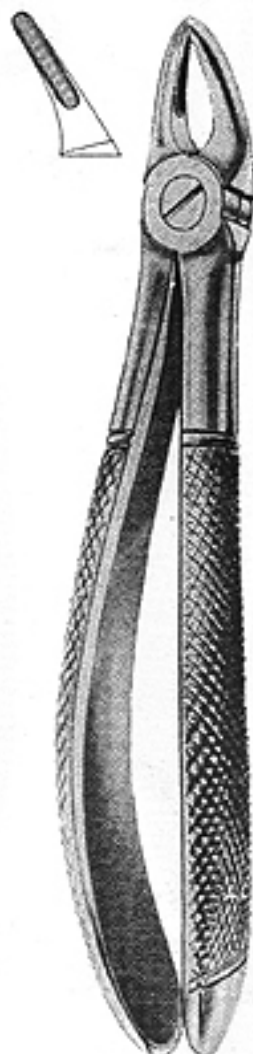

30 S
04-054-00



31
04-052-00



32
04-053-00

M. A. ARAIN & BROTHERS (PVT.) LTD.

57

EXTRACTING FORCEPS, ENGLISH PATTERN
 ZAHNZANGEN, ENGLISCHE FORM
 FORCEPS DE EXTRACCION, FORMA ENGLISA



ARAIN



33
04-055-00



33 S
04-056-00



33 A
04-057-00



33 B
04-058-00



33 L
04-059-00



ARAIN

EXTRACTING FORCEPS, ENGLISH PATTERN
ZAHNZANGEN, ENGLISCHE FORM
FORCEPS DE EXTRACCION, FORMA ENGLESA

04



39 L
04-060-00

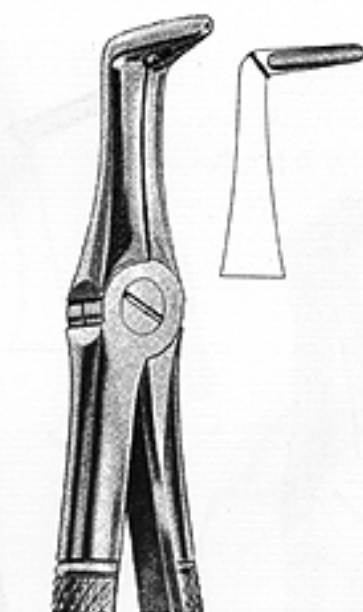

45
04-061-00

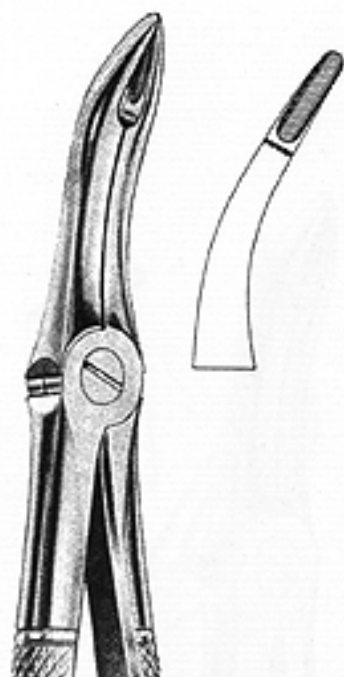

44
04-062-00



39 A
04-063-00



39 R
04-064-00

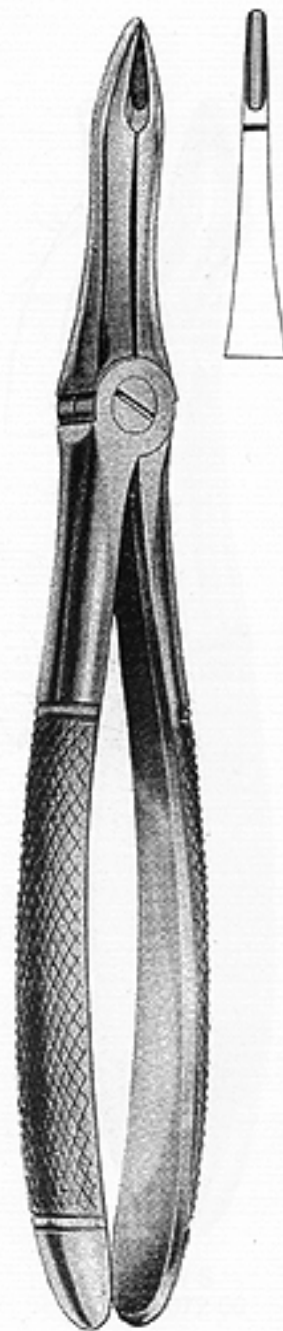

41
04-065-00

M. A. ARAIN & BROTHERS (PVT.) LTD.

59

EXTRACTING FORCEPS, ENGLISH PATTERN
 ZAHNZANGEN, ENGLISCHE FORM
 FORCEPS DE EXTRACCION, FORMA ENGLESA



ARAIN



48
04-066-00



49
04-067-00



50
04-068-00



ARAIN

EXTRACTING FORCEPS, ENGLISH PATTERN
ZAHNZANGEN, ENGLISCHE FORM
FORCEPS DE EXTRACCION, FORMA ENGLESA

04



52
04-069-00

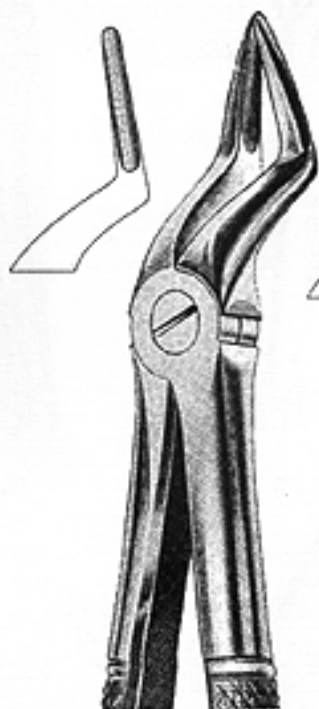

51A
04-070-00

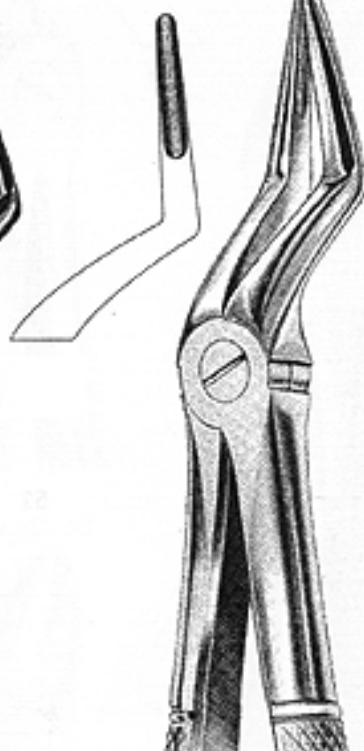

51L
04-071-00

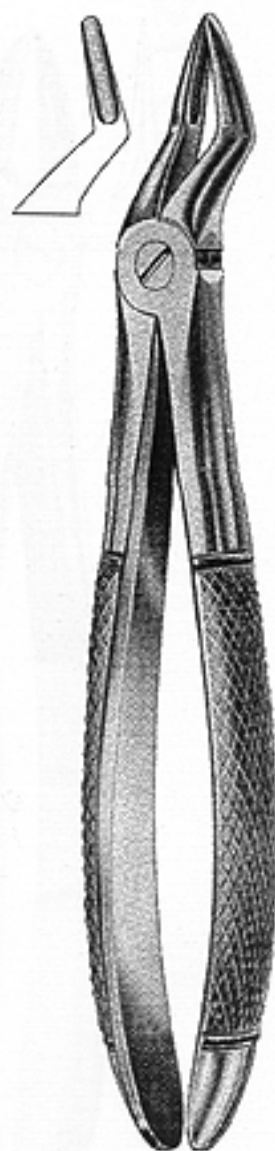

51 S
04-072-00

M. A. ARAIN & BROTHERS (PVT.) LTD.

61

EXTRACTING FORCEPS, ENGLISH PATTERN
 ZAHNZANGEN, ENGLISCHE FORM
 FORCEPS DE EXTRACCION, FORMA ENGLESA



ARAIN

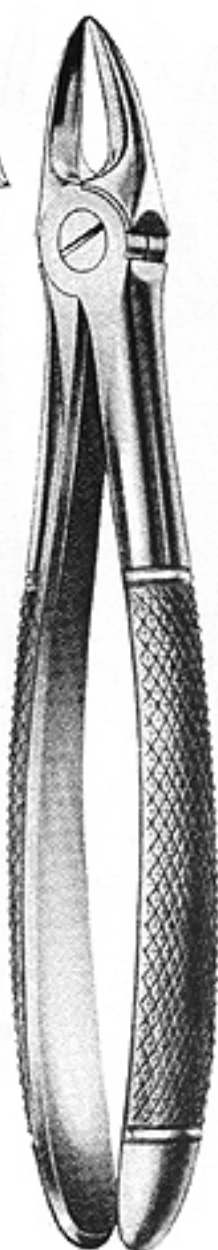

54
04-073-00

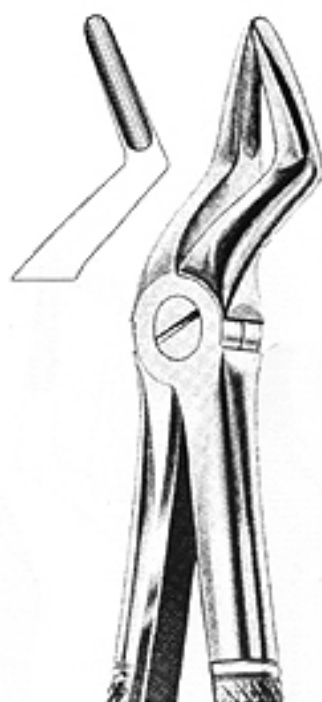

51
04-074-00

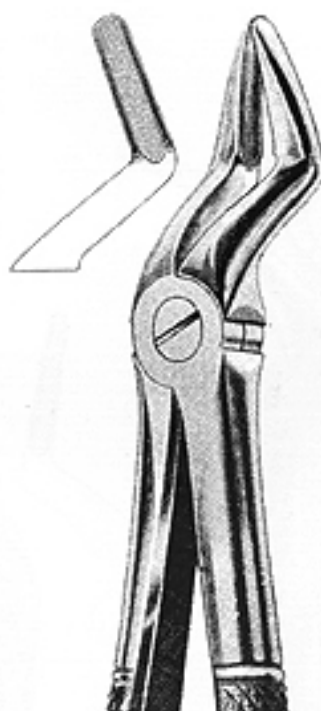

52 A
04-075-00



55
04-076-00



56
04-077-00



EXTRACTING FORCEPS, ENGLISH PATTERN
ZAHNZANGEN, ENGLISCHE FORM
FORCEPS DE EXTRACCION, FORMA ENGLESA

04



67½ L
04-078-00



67½ L
04-078-0C



67½ L
04-078-00



67½ R
04-081-00



67½ R
04-081-00



67½ R
04-081-00



65 R
04-079-00



65 L
04-080-00

EXTRACTING FORCEPS, ENGLISH PATTERN
 ZAHNZANGEN, ENGLISCHE FORM
 FORCEPS DE EXTRACCION, FORMA ENGLESA



ARAIN

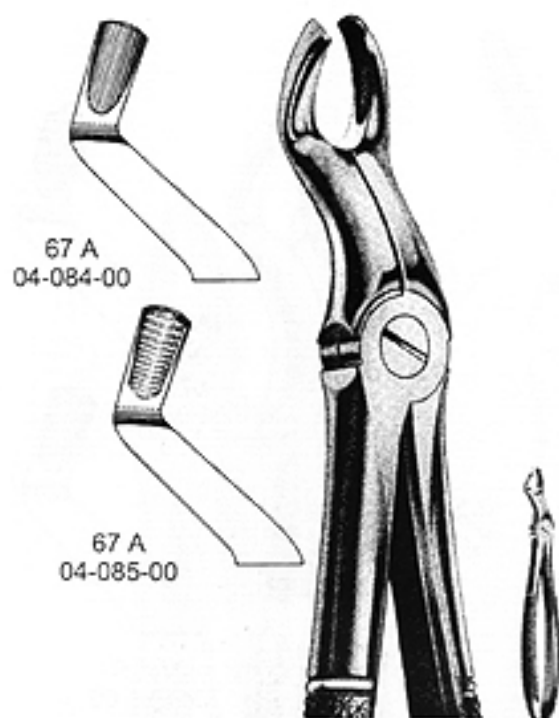

67 A
04-084-00

67 A
04-085-00

67 A
04-084-00

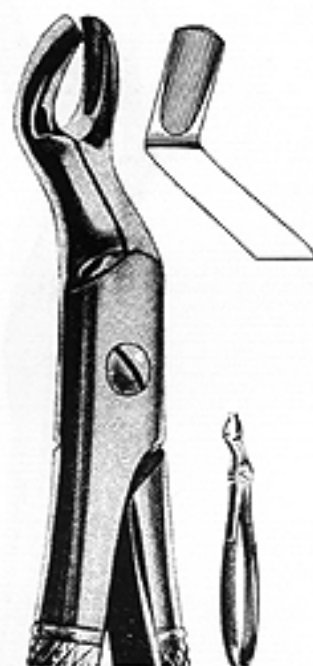

67
04-086-00

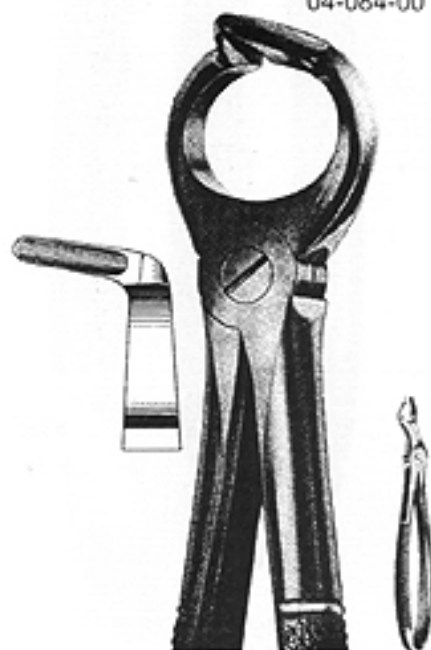

68
04-087-00



68 A
04-088-00



ARAIN

EXTRACTING FORCEPS, ENGLISH PATTERN
ZAHNZANGEN, ENGLISCHE FORM
FORCEPS DE EXTRACCION, FORMA ENGLESA

04



73 L
04-091-00



73 A
04-094-00



73 R
04-092-00

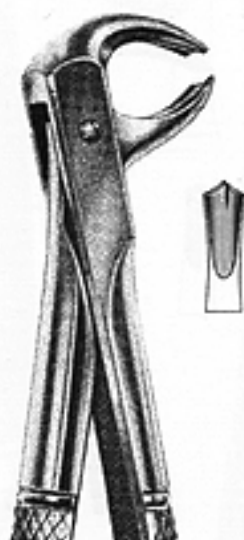

73
04-093-00

EXTRACTING FORCEPS, ENGLISH PATTERN
 ZAHNZANGEN, ENGLISCHE FORM
 FORCEPS DE EXTRACCION, FORMA ENGLESA



ARAIN



74 M
04-095-00

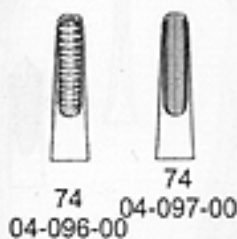

74
04-096-00

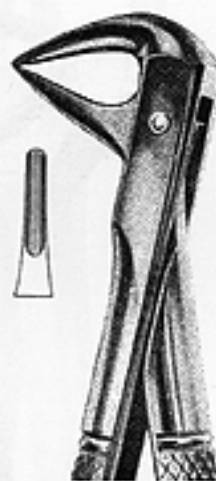

74 N
04-098-00



74 D
04-099-00



75
04-100-00



ARAIN

EXTRACTING FORCEPS, ENGLISH PATTERN
ZAHNZANGEN, ENGLISCHE FORM
FORCEPS DE EXTRACCION, FORMA ENGLESA

04

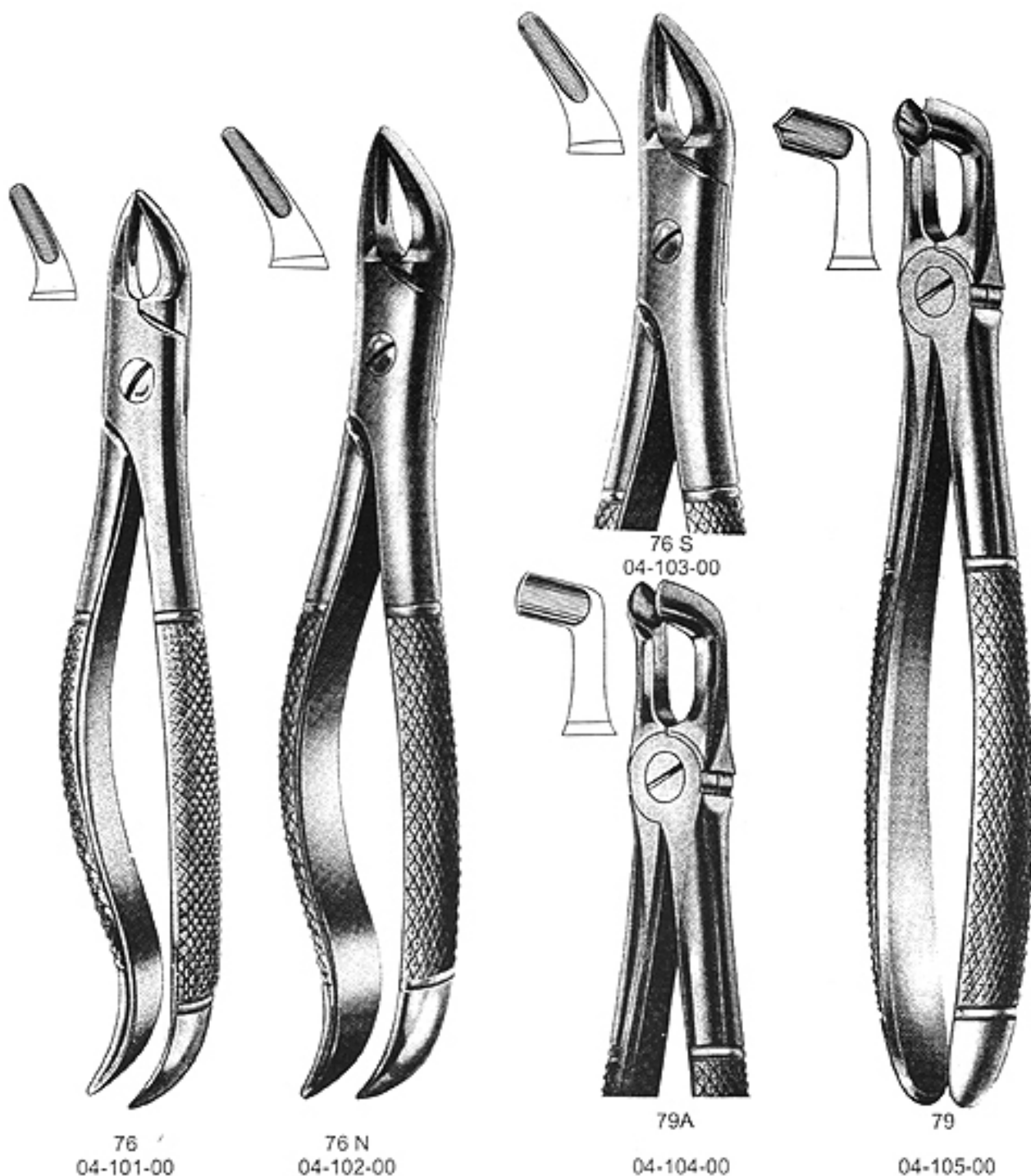

EXTRACTING FORCEPS, ENGLISH PATTERN
 ZAHNZANGEN, ENGLISCHE FORM
 FORCEPS DE EXTRACCION, FORMA ENGLESA



ARAIN

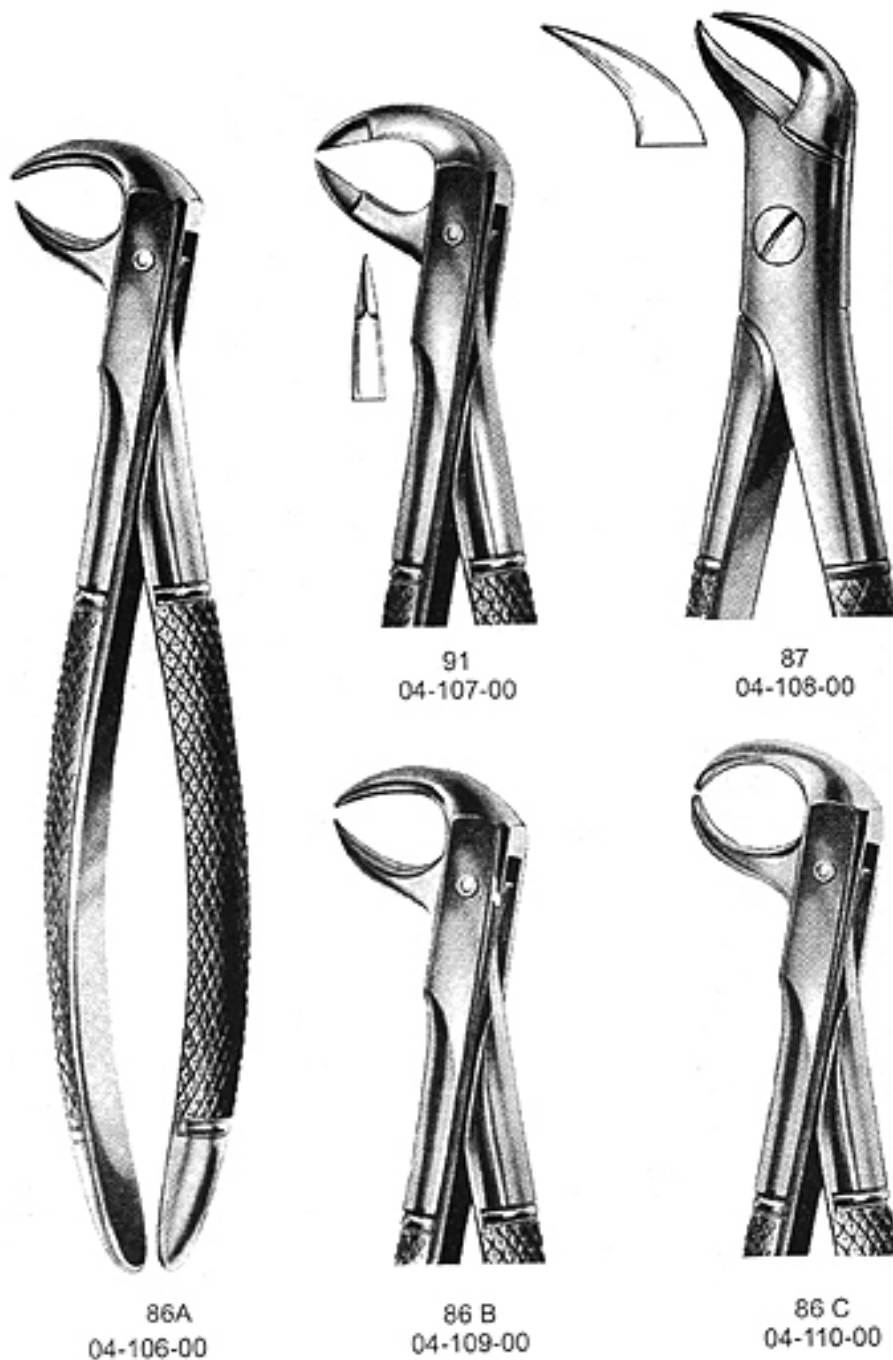



ARAIN

EXTRACTING FORCEPS, ENGLISH PATTERN
ZAHNZANGEN, ENGLISCHE FORM
FORCEPS DE EXTRACCION, FORMA ENGLESA

04

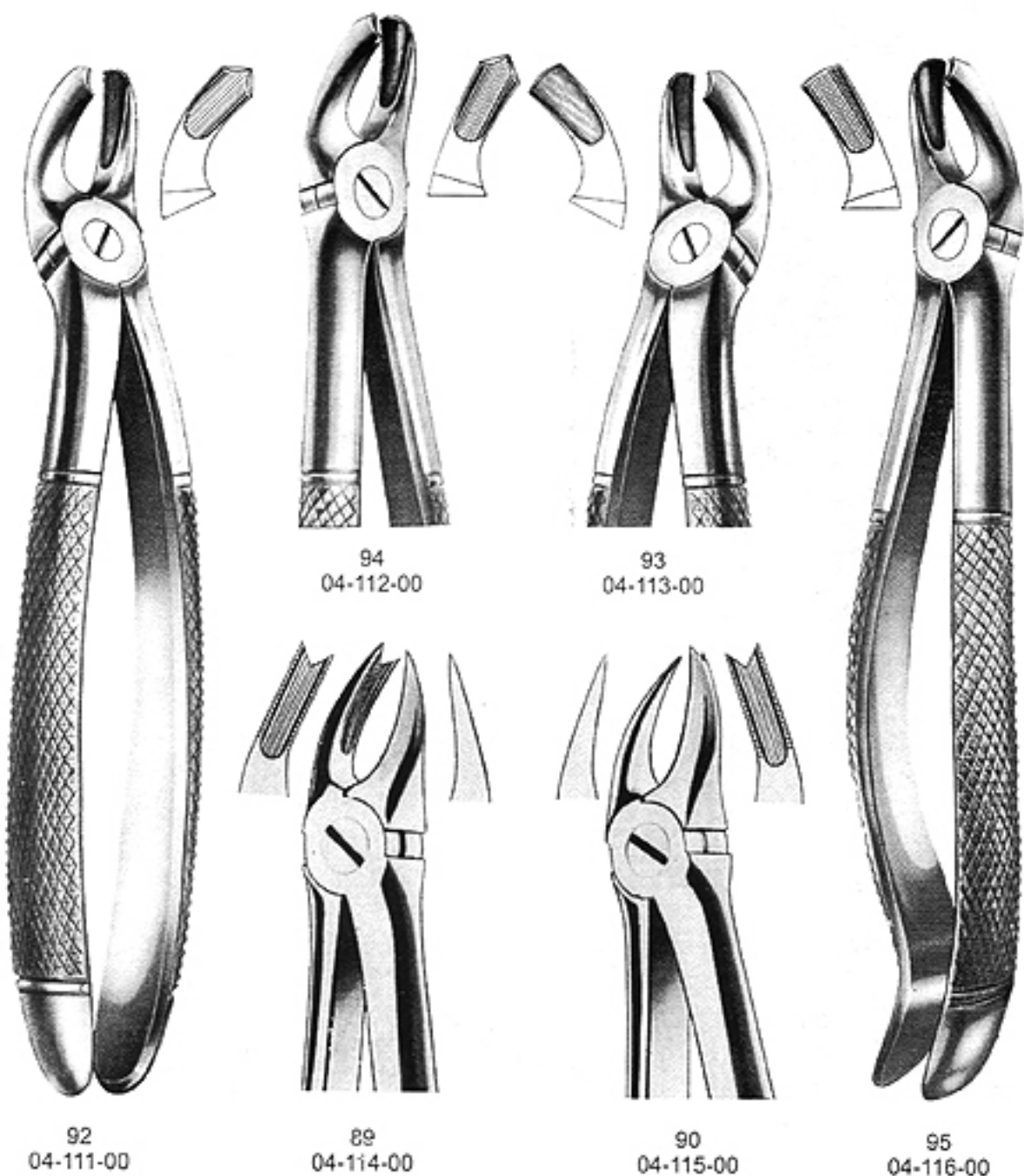

M. A. ARAIN & BROTHERS (PVT.) LTD.

EXTRACTING FORCEPS, ENGLISH PATTERN
 ZAHNZANGEN, ENGLISCHE FORM
 FORCEPS DE EXTRACCION, FORMA ENGLESA



ARAIN

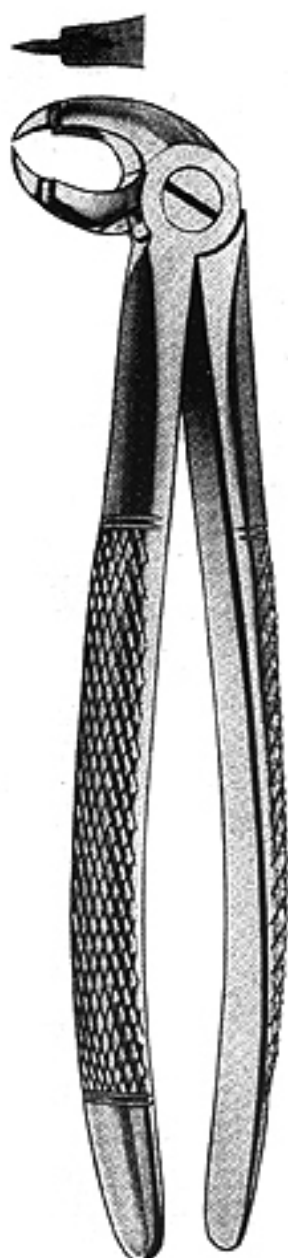

98
04-117-00



99
04-118-00

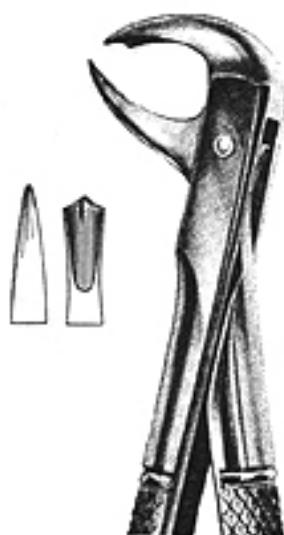

99 1/2
04-119-00

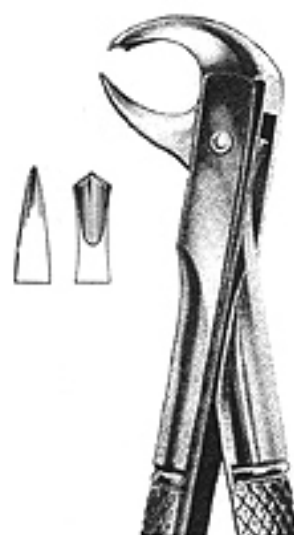

99 1/4
04-120-00



EXTRACTING FORCEPS, ENGLISH PATTERN
ZAHNZANGEN, ENGLISCHE FORM
FORCEPS DE EXTRACCION, FORMA ENGLESA

04

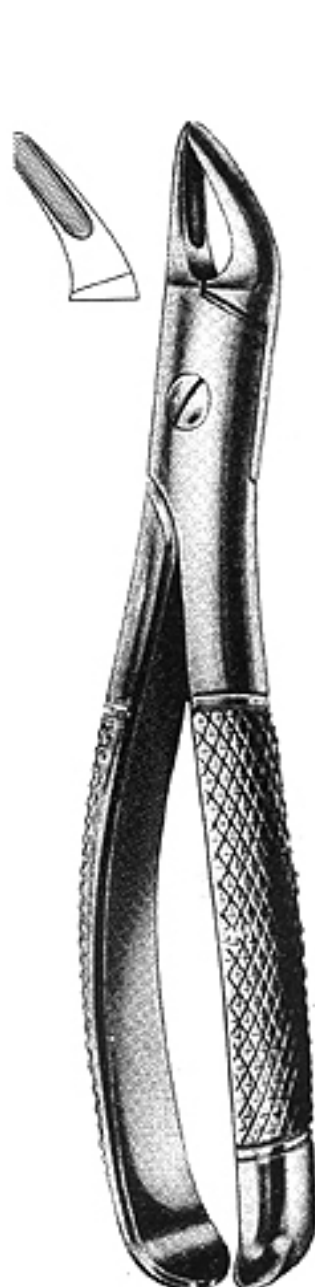

100
04-121-00

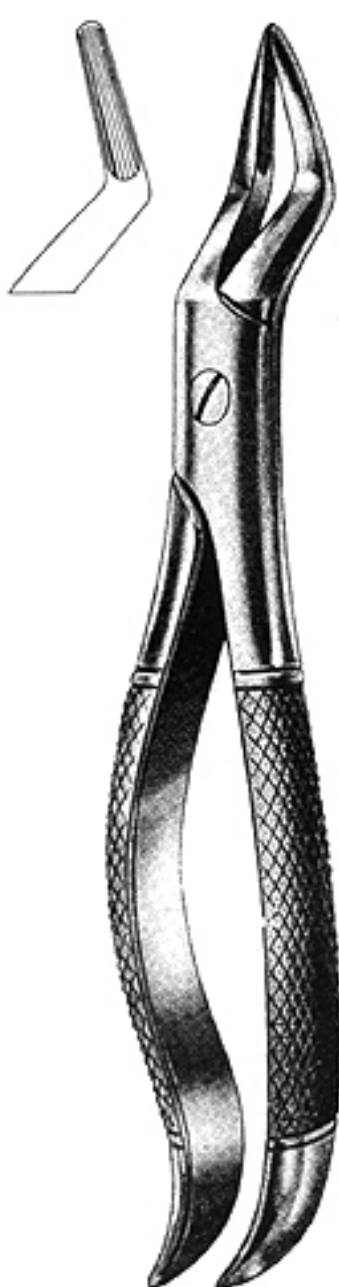

101
04-122-00

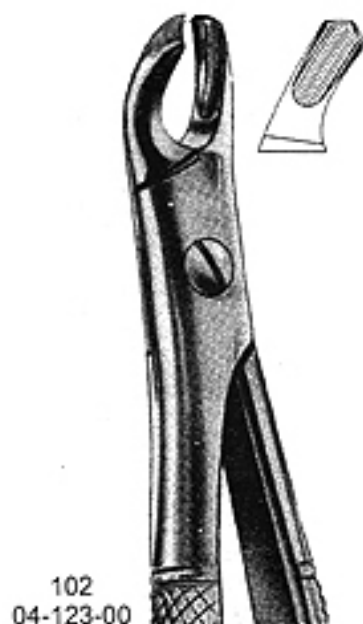

102
04-123-00



103
04-124-00

EXTRACTING FORCEPS, ENGLISH PATTERN
 ZAHNZANGEN, ENGLISCHE FORM
 FORCEPS DE EXTRACCION, FORMA ENGLESA



ARAIN

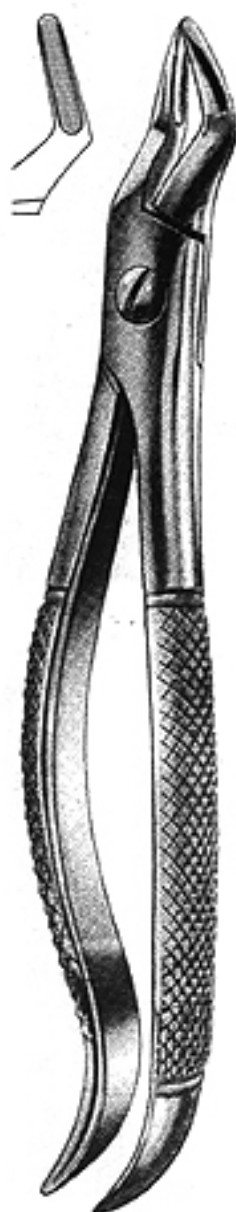

104
04-125-00



105
04-126-00

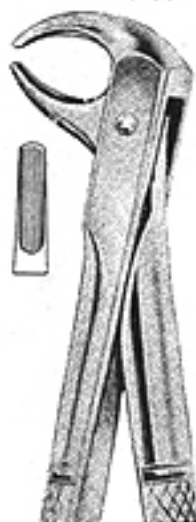

106
04-127-00

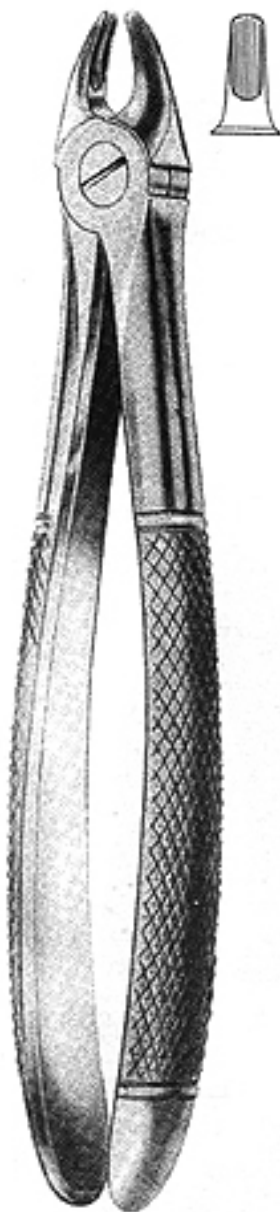

107
04-128-00



ARAIN

EXTRACTING FORCEPS, ENGLISH PATTERN
ZAHNZANGEN, ENGLISCHE FORM
FORCEPS DE EXTRACCION, FORMA ENGLESA

04

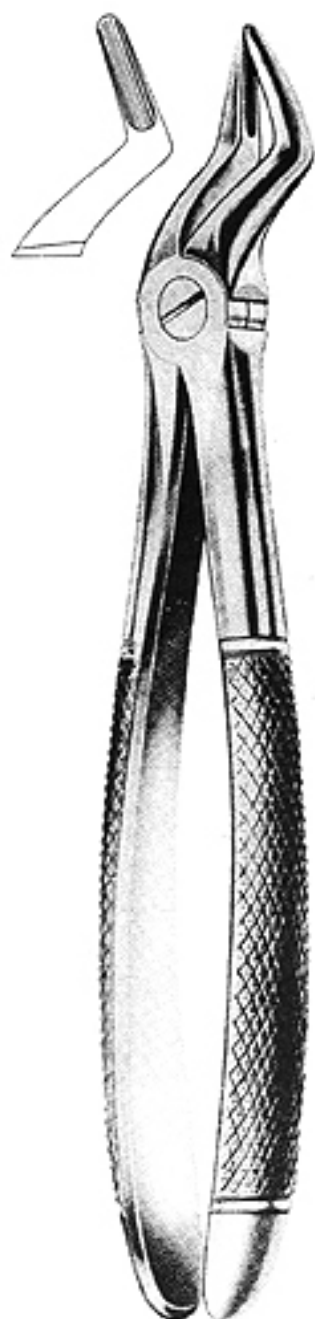

112
04-129-00



113
04-130-00



114
04-131-00

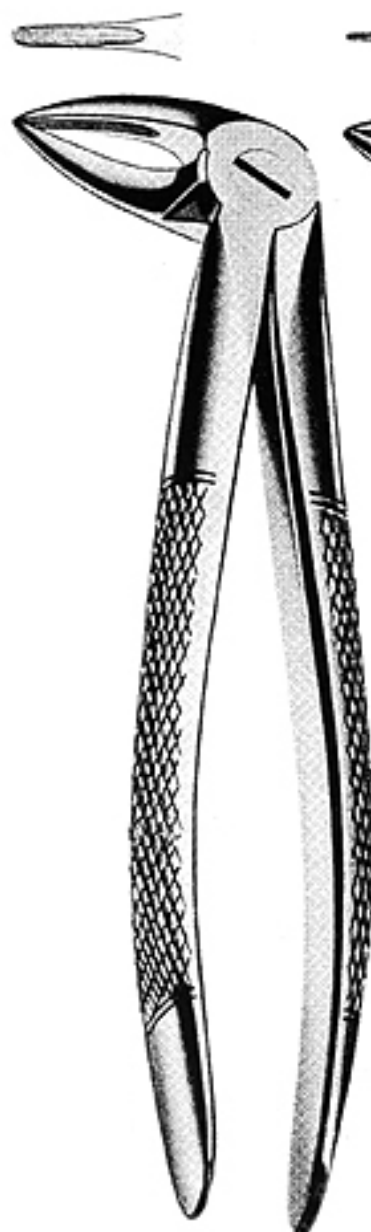

133 1/2
04-132-00

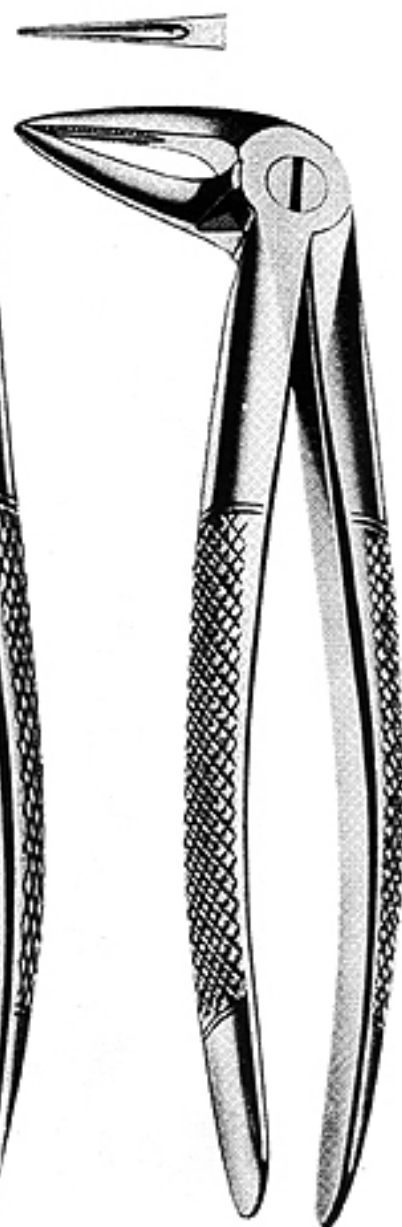

33 1/2
04-133-00

M. A. ARAIN & BROTHERS (PVT.) LTD.

73

EXTRACTING FORCEPS, ENGLISH PATTERN
 ZAHNZANGEN, ENGLISCHE FORM
 FORCEPS DE EXTRACCION, FORMA ENGLESA



ARAIN

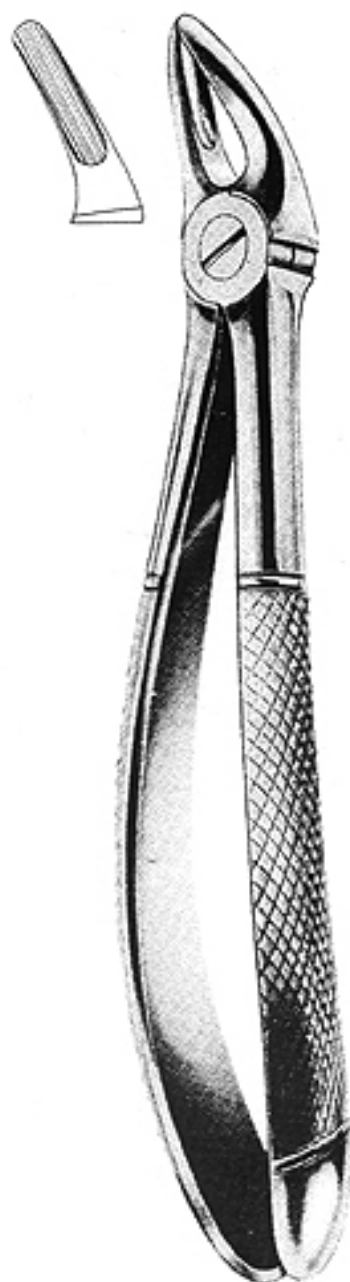

136
04-134-00

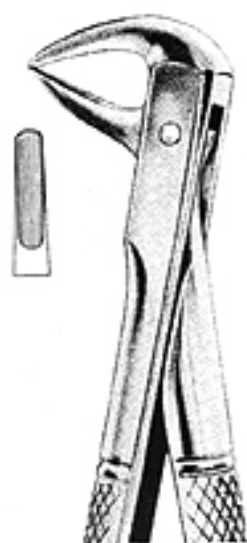

137
04-135-00



143
04-136-00

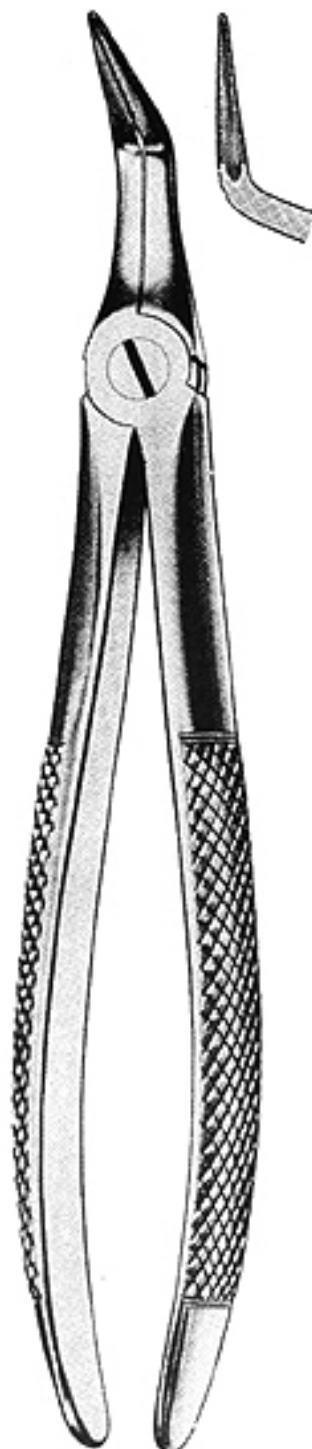

145
04-137-00

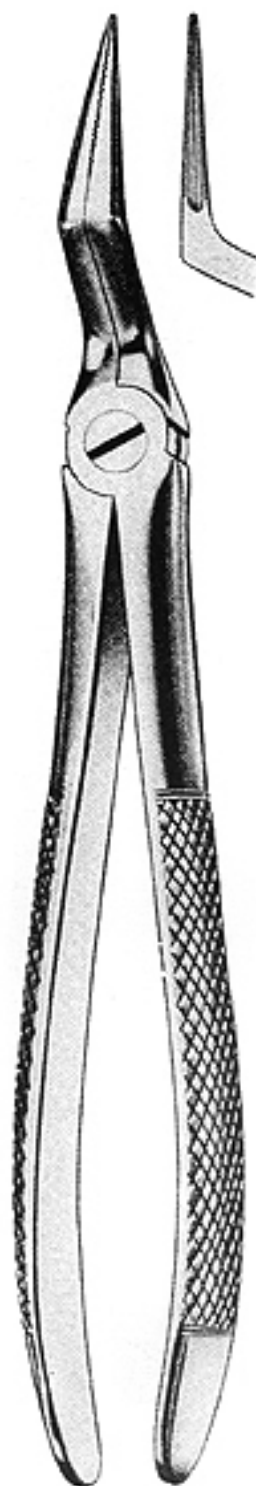

151 1/2
04-138-00



STUDENTS SET
CONSISTING 10 EXTRACTIONS FORCEPS

04

STUDENT SET, AVAILABLE
TEN PIECE IN ONE PACKING

ONE SET CONTAINS:

1 X# 2	1 X# 51
1 X# 7	1 X# 67
1 X# 13	1 X# 73
1 X# 18	1 X# 74
1 X# 17	1 X# 79A

04-175-00

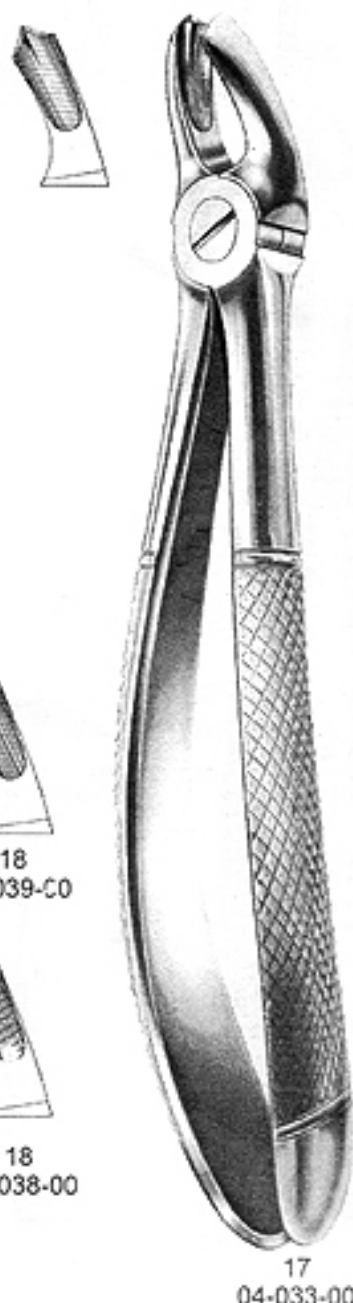
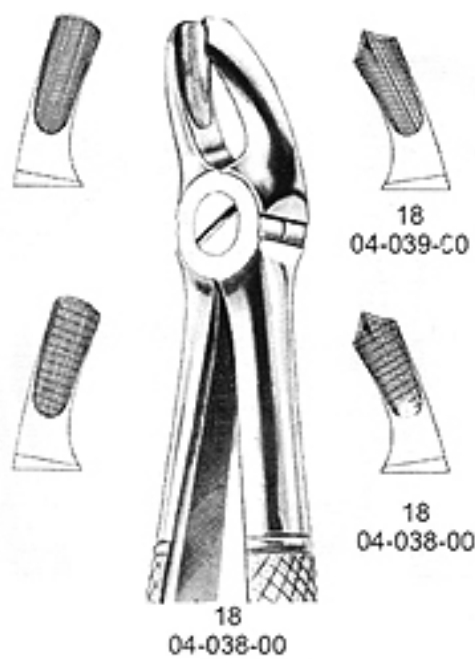
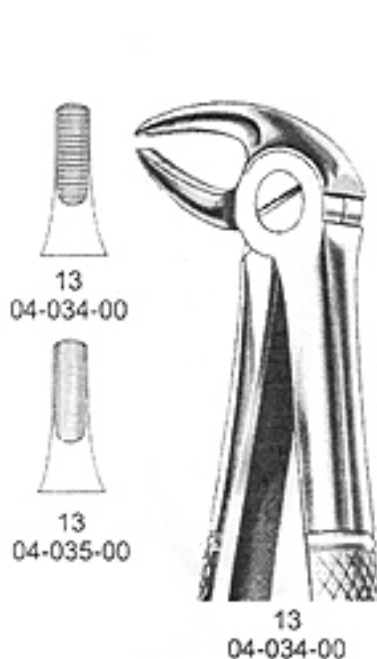
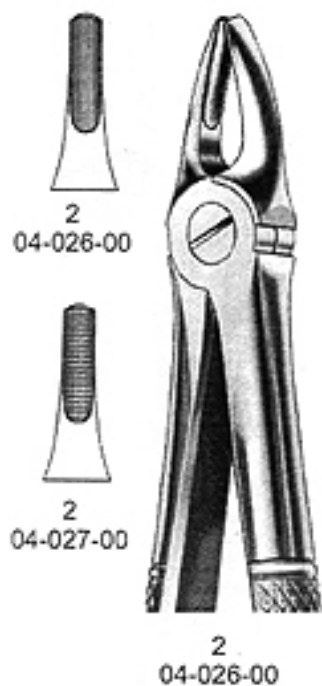

M. A. ARAIN & BROTHERS (PVT.) LTD.

STUDENTS SET
CONSISTING 10 EXTRACTIONS FORCEPS



ONE SET CONTAINS:

1 X # 2	04-026-00, 04-027-00	1 X # 51	04-069-00, 04-070-00
1 X # 7	04-030-00, 04-031-00	1 X # 67	04-086-00.
1 X # 13	04-034-00, 04-035-00	1 X # 73	04-093-00.
1 X # 18	04-038-00, 04-039-00	1 X # 74	04-096-00, 04-097-00
1 X # 17	04-033-00.	1 X # 79A	04-105-00

STUDENT SET, AVAILABLE
TEN PIECE IN ONE PACKING

04-175-00



51
04-069-00

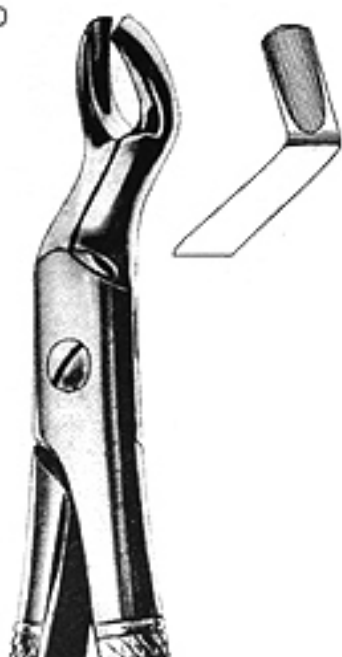

67
04-086-00

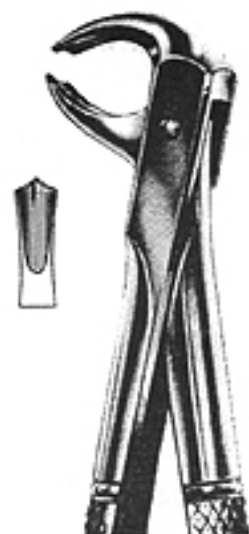

73
04-093-00



74
04-097-00



74
04-096-00



74
04-096-00

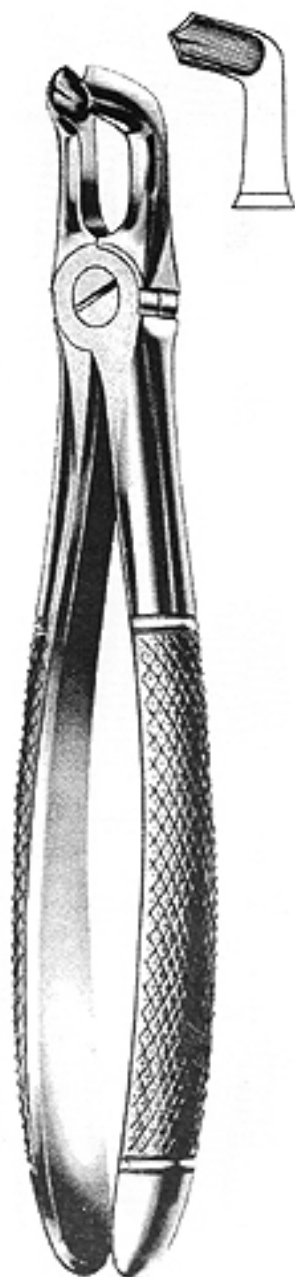

79
04-105-00



STUDENTS SET
EXTRACTING FORCEPS FOR CHILDREN, ENGLISH PATTERN
FOR CHILDREN PACK OF 5 PIECES

04



1
04-275-00

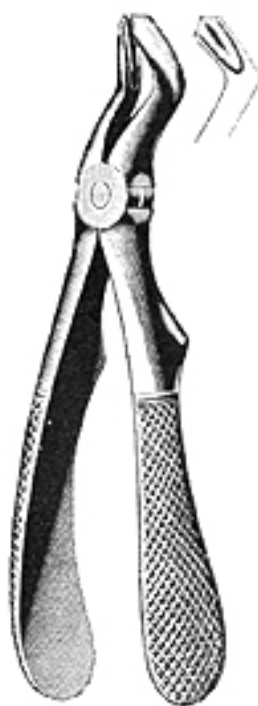

3
04-276-00

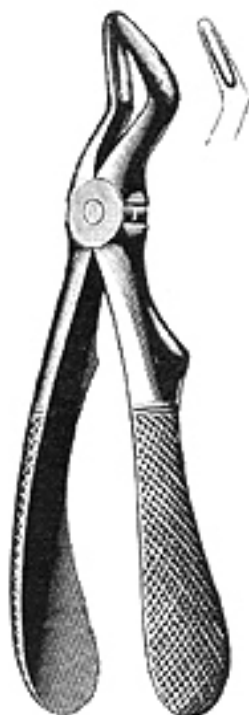

4
04-280-00

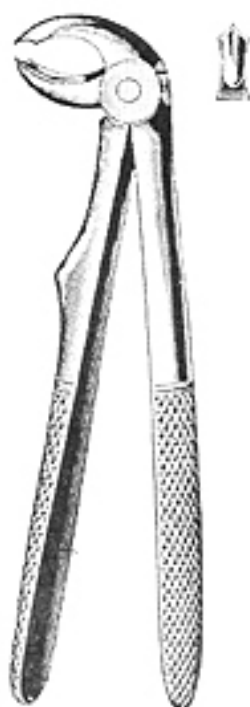

6
04-281-00

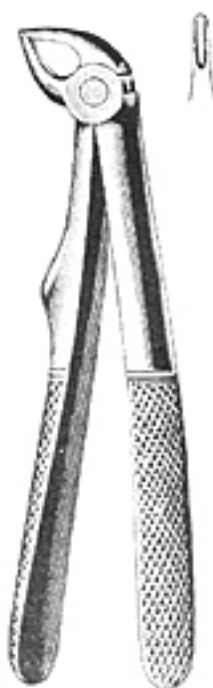

7
04-278-00

ONE SET CONTAINS:

- 1 X # 1 04-275-00
- 1 X # 3 04-276-00
- 1 X # 4 04-280-00
- 1 X # 6 04-281-00
- 1 X # 7 04-278-00

04-176-00

WITH SPRING

04-177-00

RESECTION FORCEPS
 PINCES A RESECCION
 FORCEPS DE RESECCION



ARAIN

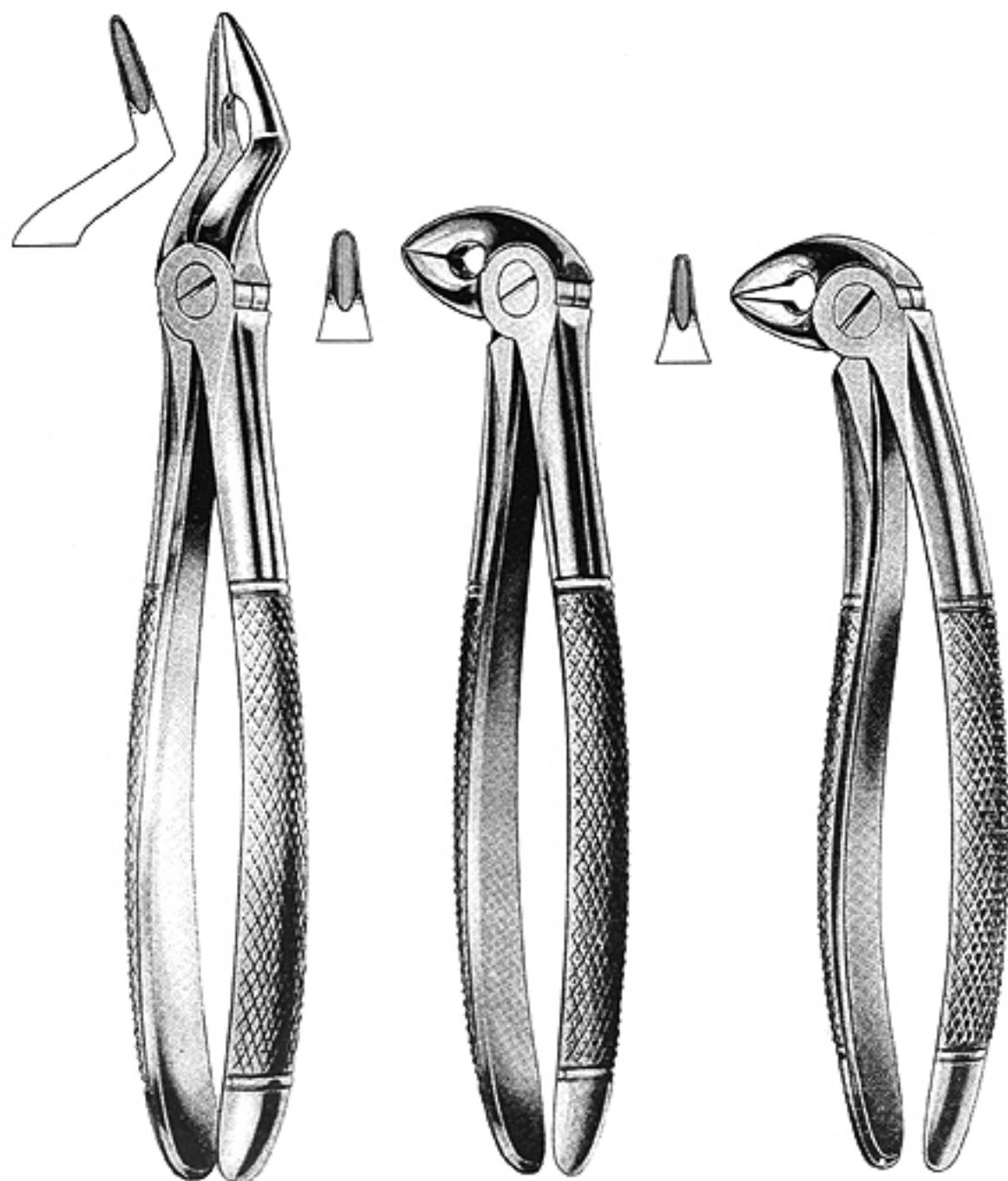

04-161-00
 Witzel

04-162-00

Busch

04-163-00



ARAIN

EXTRACTING FORCEPS
DAVIERS
FORCEPS DE EXTRACCION

ENGLISH PATTERN
FORME ANGLAISE
FORMA INGLESA

04



04-164-00



04-165-00



04-166-00

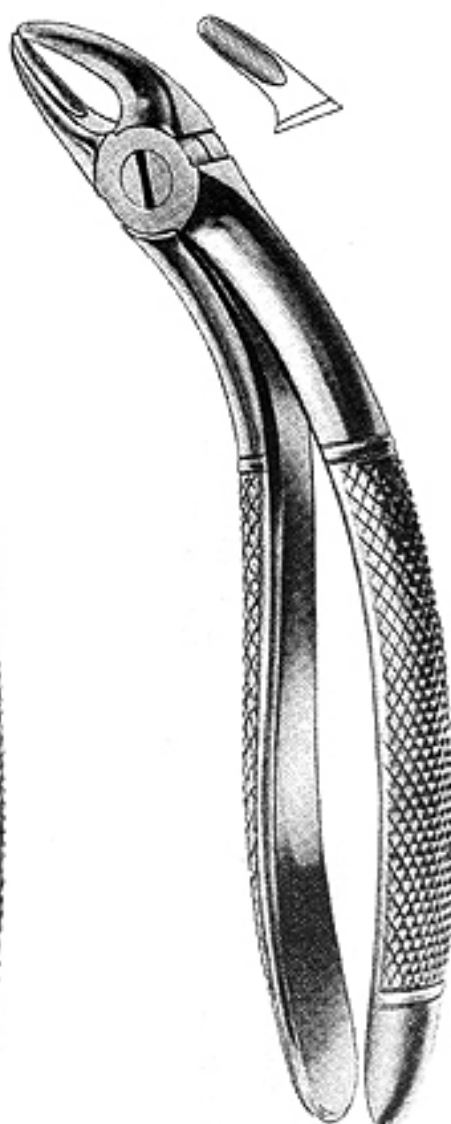

04-167-00

Stiksa

Hertz

M. A. ARAIN & BROTHERS (PVT.) LTD.

79

WISDOM EXTRACTING FORCEPS
 DAVIERS POUR DENTS DE SAGESSE
 FORCEPS PARA CORDALES



ARAIN

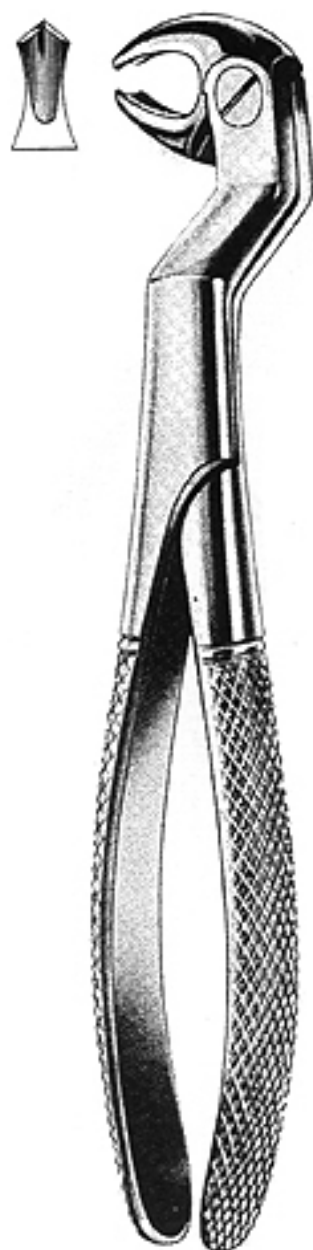

22 ½ L
 04-168-00



33 ½ L
 04-169-00



33 ½ R
 04-170-00

Routurier



22 ½ R
 04-171-00

Routurier

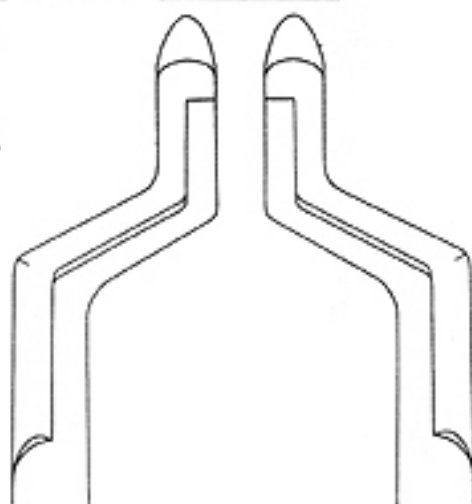



ARAIN

ROOT SPLINTER FORCEPS
PINCES A FRAGMENTOS
PINZAS PARA FRAGMENTOS

04

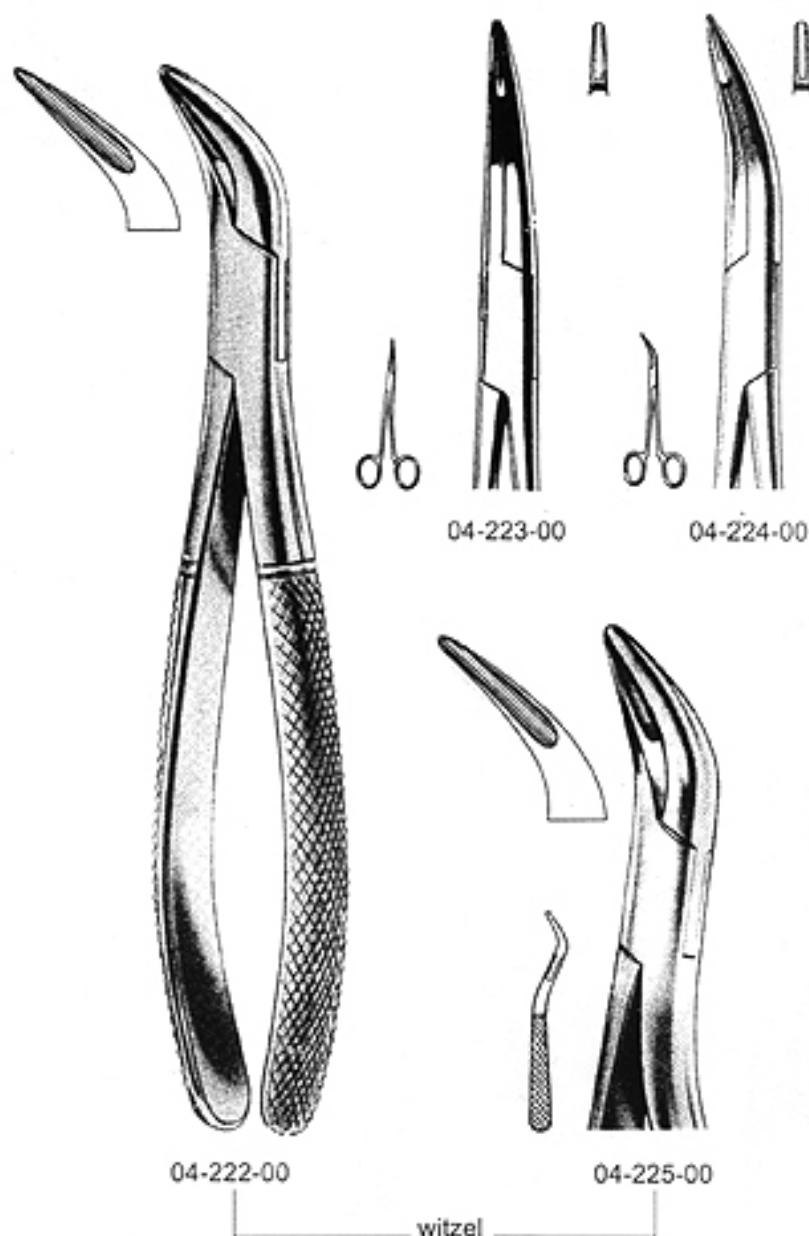

EXTRACTING FORCEPS, FOR CHILDREN, ENGLISH PATTERN
 ZAHNZANGE FÜR KINDER MIT, ENGLISCHE FORM
 FORCEPS DE EXTRACCION PARA CON, FORMA ENGLISH



ARAIN



1
04 275-00



3
04 276-00



5
04 277-00



7
04 278-00

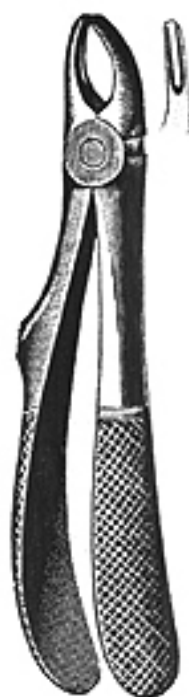

2
04 279-00



4
04-280-00



6
04-281-00



ARAIN

EXTRACTING FORCEPS, FOR CHILDREN, ENGLISH PATTERN
ZAHNZANGE FÜR KINDER MIT FEDER, ENGLISCHE FORM
FORCEPS DE EXTRACCION PARA CON REAORTE, FORMA
ENGLISH

04



137
04-282-00



139
04-283-00



51
04-284-00

Klein

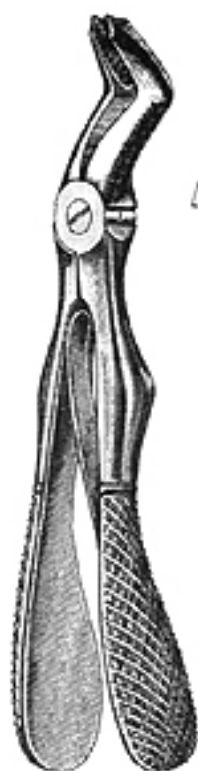

3
04-285-00

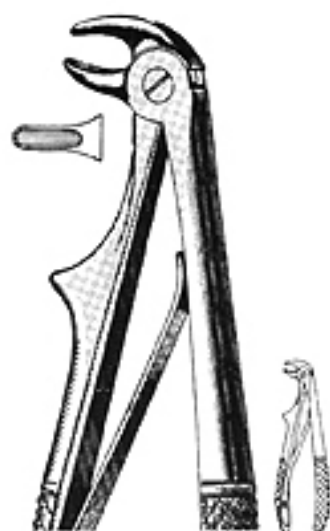

5
04-286-00



6
04-287-00

Klein

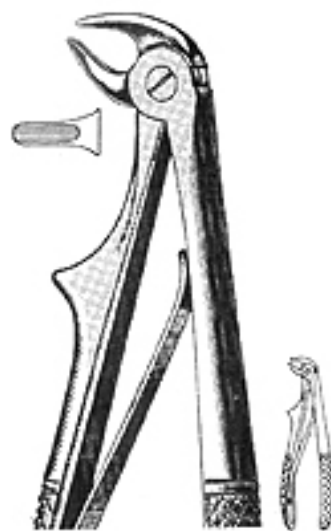

7
04-288-00

EXTRACTING FORCEPS, ENGLISH PATTERN
 ZAHNZANGE ENGLISCHE FORM
 FORCEPS DE EXTRACCION FORMA ENGLESA



ARAIN



13 K
04-289-00



33 K
04-290-00



40
04-291-00



22 K
04-292-00



38
04-293-00



73 K
04-294-00



ARAIN

EXTRACTING FORCEPS, ENGLISH PATTERN
ZAHNZANGE ENGLISCHE FORM
FORCEPS DE EXTRACCION FORMA ENGLESA

04



17 K
04-295-00



18 K
04-296-00



18 K
04-297-00



29 K
04-298-00



51 K
04-299-00



39 K
04-300-00



37
04-301-00

M. A. ARAIN & BROTHERS (PVT.) LTD.

85

EXTRACTING FORCEPS, ENGLISH PATTERN
 ZAHNZANGE ENGLISCHE FORM
 FORCEPS DE EXTRACCION FORMA ENGLESA



ARAIN



**WITH DIAMOND
 DUST COATING**

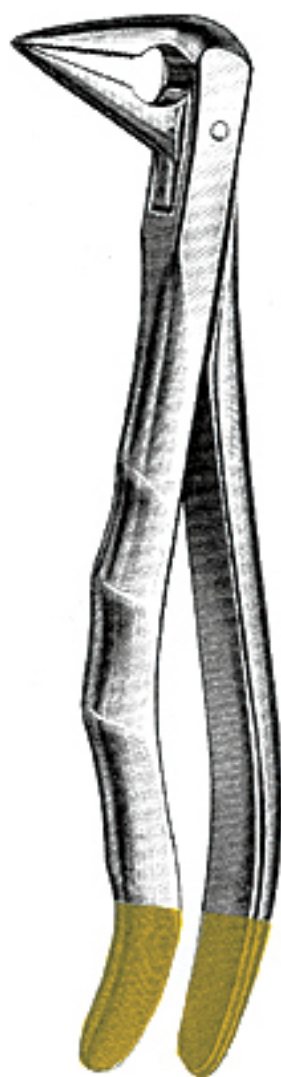

59
 04-351-00

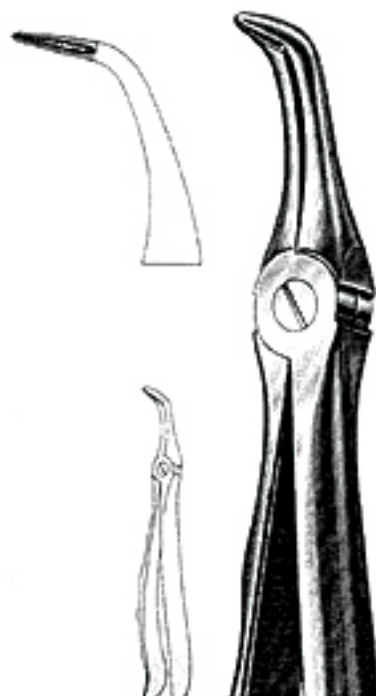

46
 04-352-00

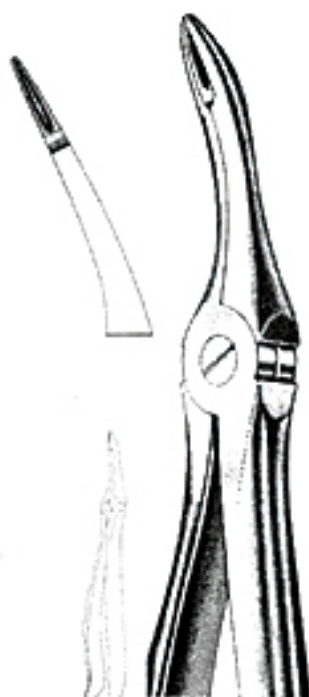

49
 04-353-00

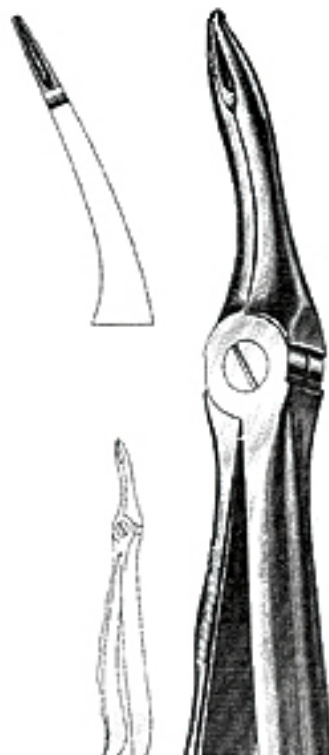

44
 04-354-00



EXTRACTING FORCEPS, AMERICAN PATTERN
ZAHNZANGE AMERICAN FORM
FORCEPS DE EXTRACCION FORMA AMERICANA

04



1
04-405-00
Standard

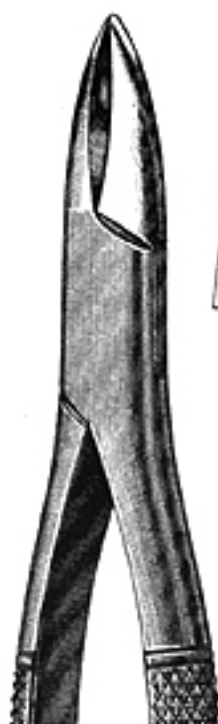

1 A
04-406-00
Henahan

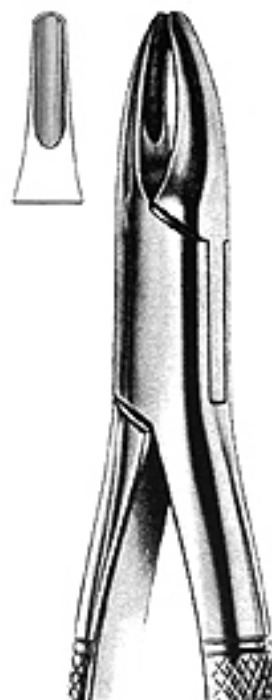

1 B
04-407-00
Normal



2
04-408-00

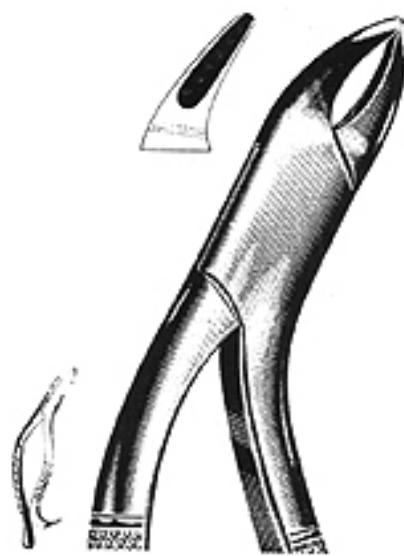

3
04-409-00

EXTRACTING FORCEPS, AMERICAN PATTERN
 ZAHNZANGE AMERICAN FORM
 FORCEPS DE EXTRACCION FORMA AMERICANA

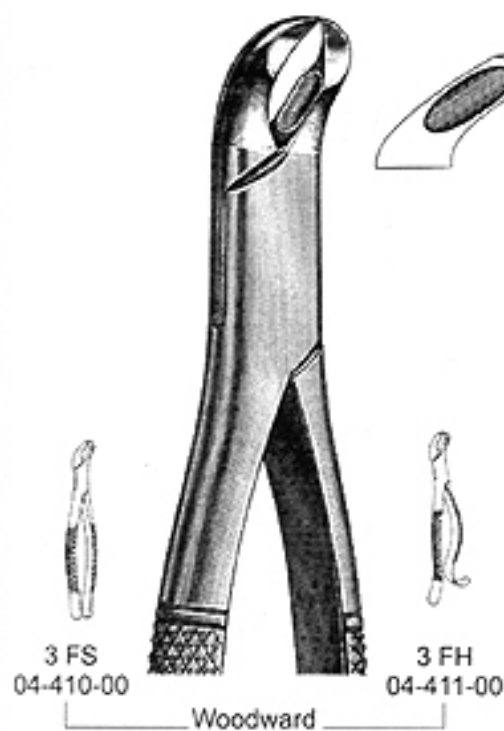
10 S
04-413-00
Standard

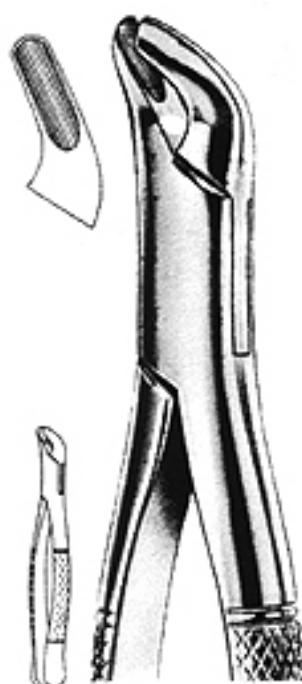
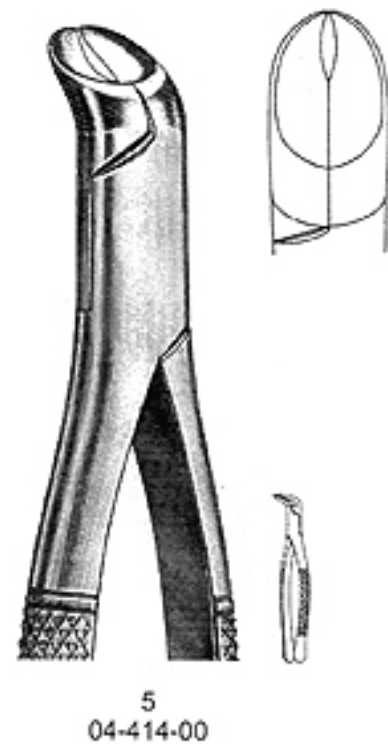

4
04-412-00

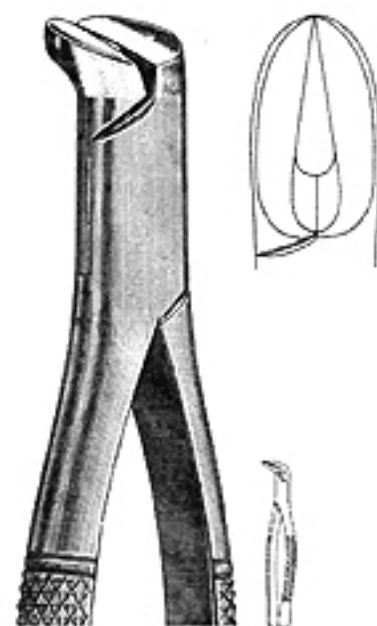

6
04-415-00



EXTRACTING FORCEPS, AMERICAN PATTERN
ZAHNZANGEN AMERICAN FORM
FORCEPS DE EXTRACCION FORMA AMERICANA

04

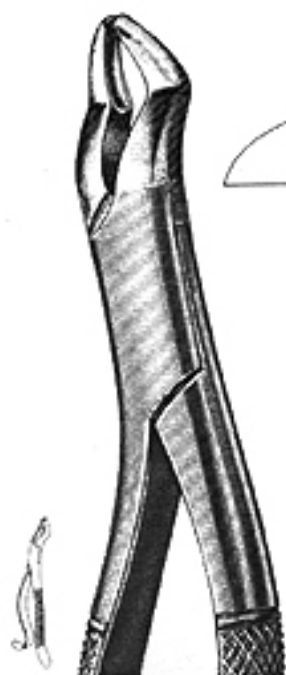

10 H
04-416-00



13
04-417-00



14
04-418-00

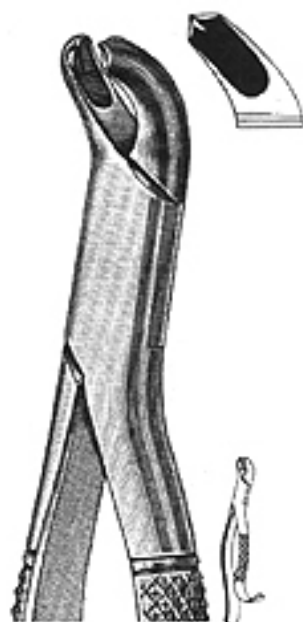

15
04-419-00
Harris

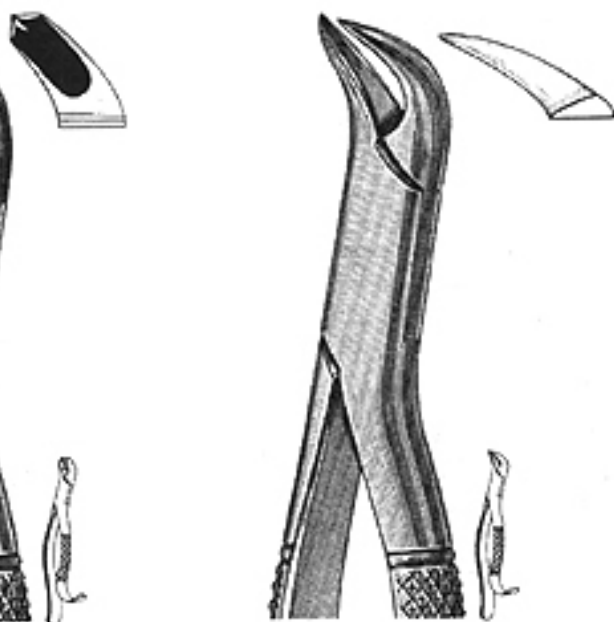

16
04-420-00



16 S
04-421-00

EXTRACTING FORCEPS, AMERICAN PATTERN
 ZAHNZANGE AMERICAN FORM
 FORCEPS DE EXTRACCION FORMA AMERICANA



ARAIN

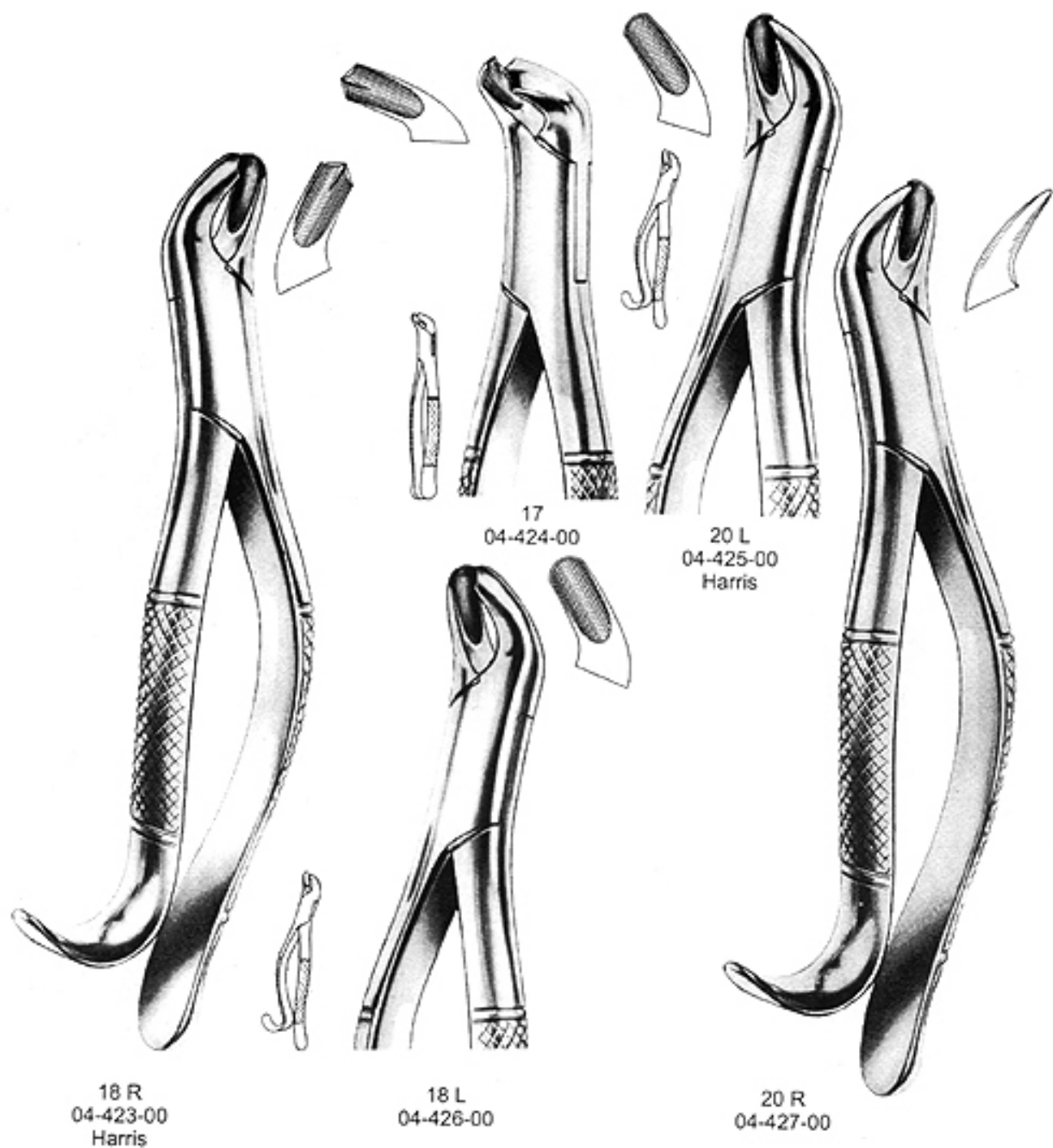



ARAIN

EXTRACTING FORCEPS, AMERICAN PATTERN
ZAHNZANGEN AMERICAN FORM
FORCEPS DE EXTRACCION FORMA AMERICANA

04



23
04-428-00

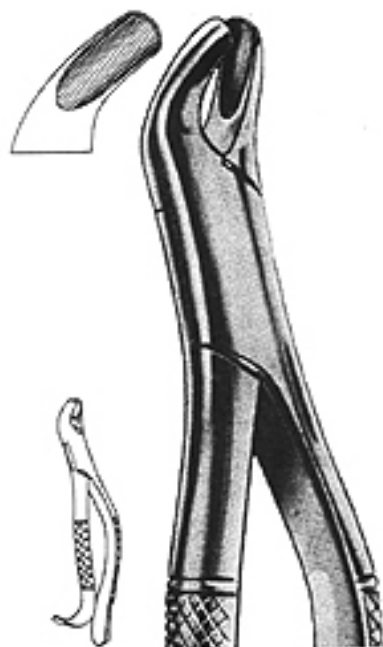

24
04-429-00

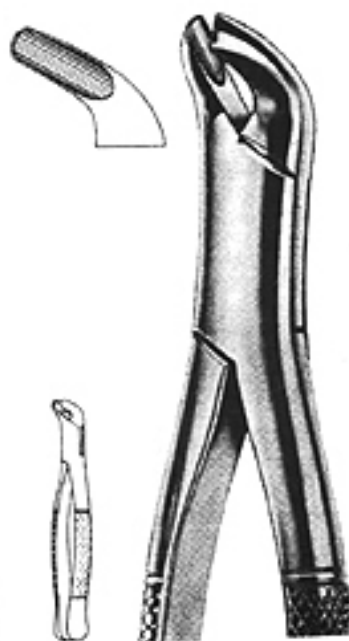

27
04-430-00

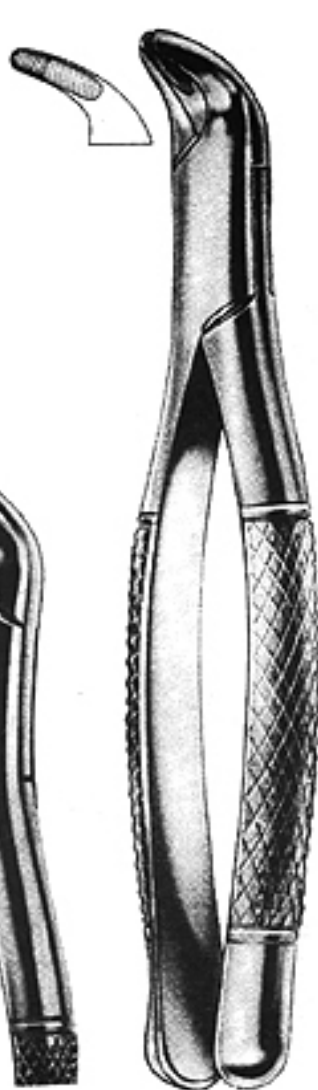

29 S
04-431-00

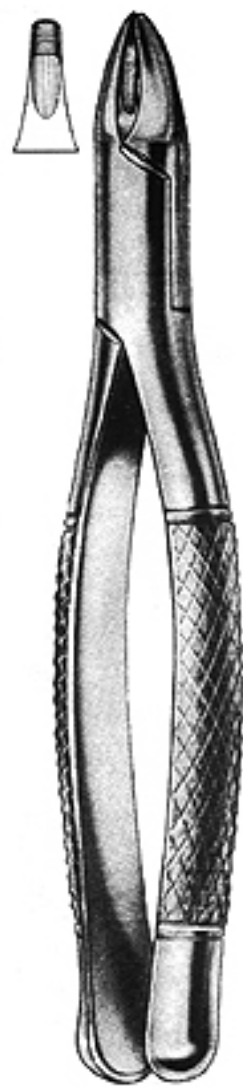

30 S
04-432-00

M. A. ARAIN & BROTHERS (PVT.) LTD.

EXTRACTING FORCEPS, AMERICAN PATTERN
 ZAHNZANGE AMERICAN FORM
 FORCEPS DE EXTRACCION FORMA AMERICANA



ARAIN

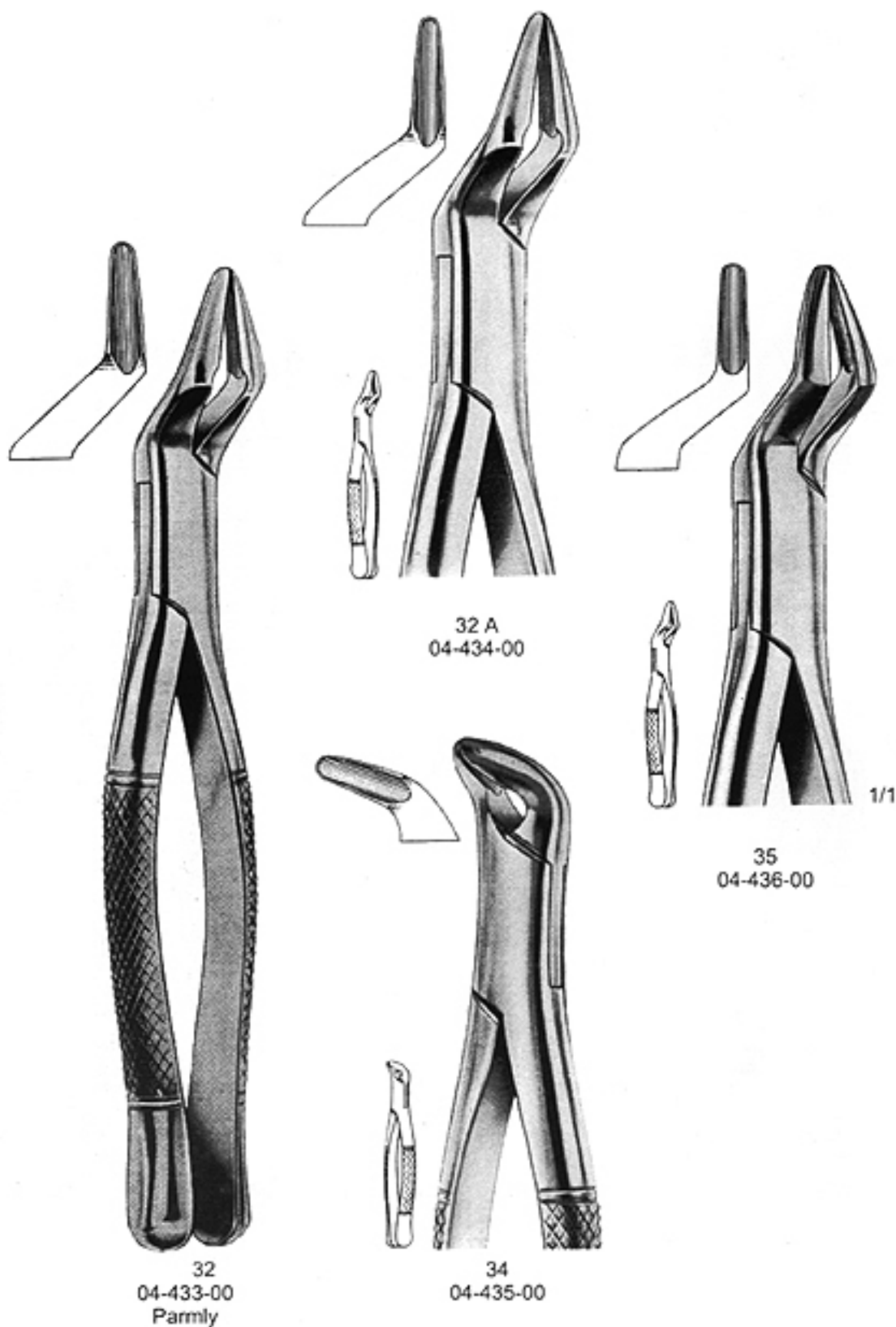



EXTRACTING FORCEPS, AMERICAN PATTERN
ZAHNZANGE AMERICAN FORM
FORCEPS DE EXTRACCION FORMA AMERICANA

04

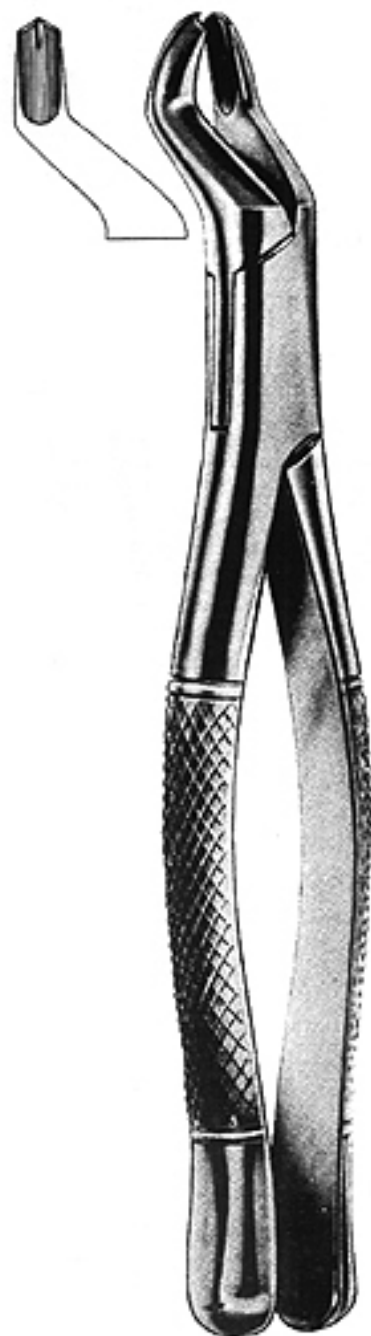

53 R
04-437-00

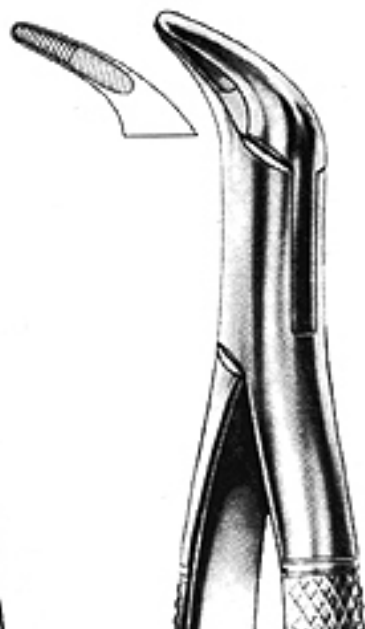

36
04-438-00

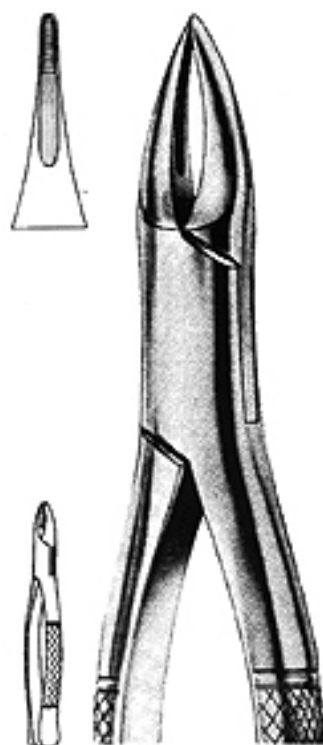

38
04-439-00

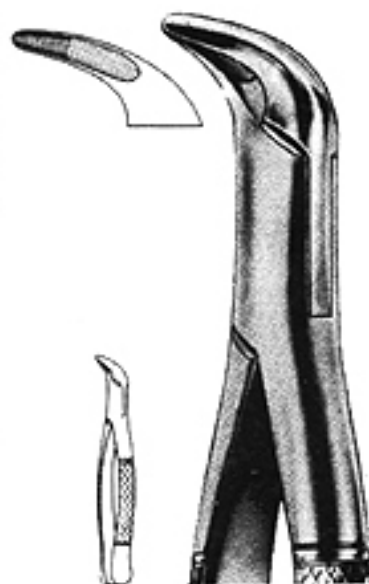

37
04-440-00

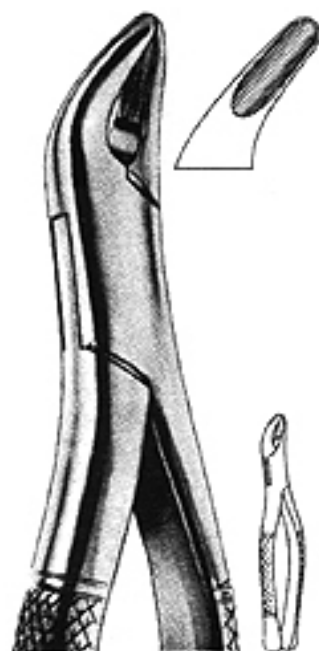

62
04-441-00

EXTRACTING FORCEPS, AMERICAN PATTERN
 ZAHNZANGE AMERICAN FORM
 FORCEPS DE EXTRACCION FORMA AMERICANA



ARAIN

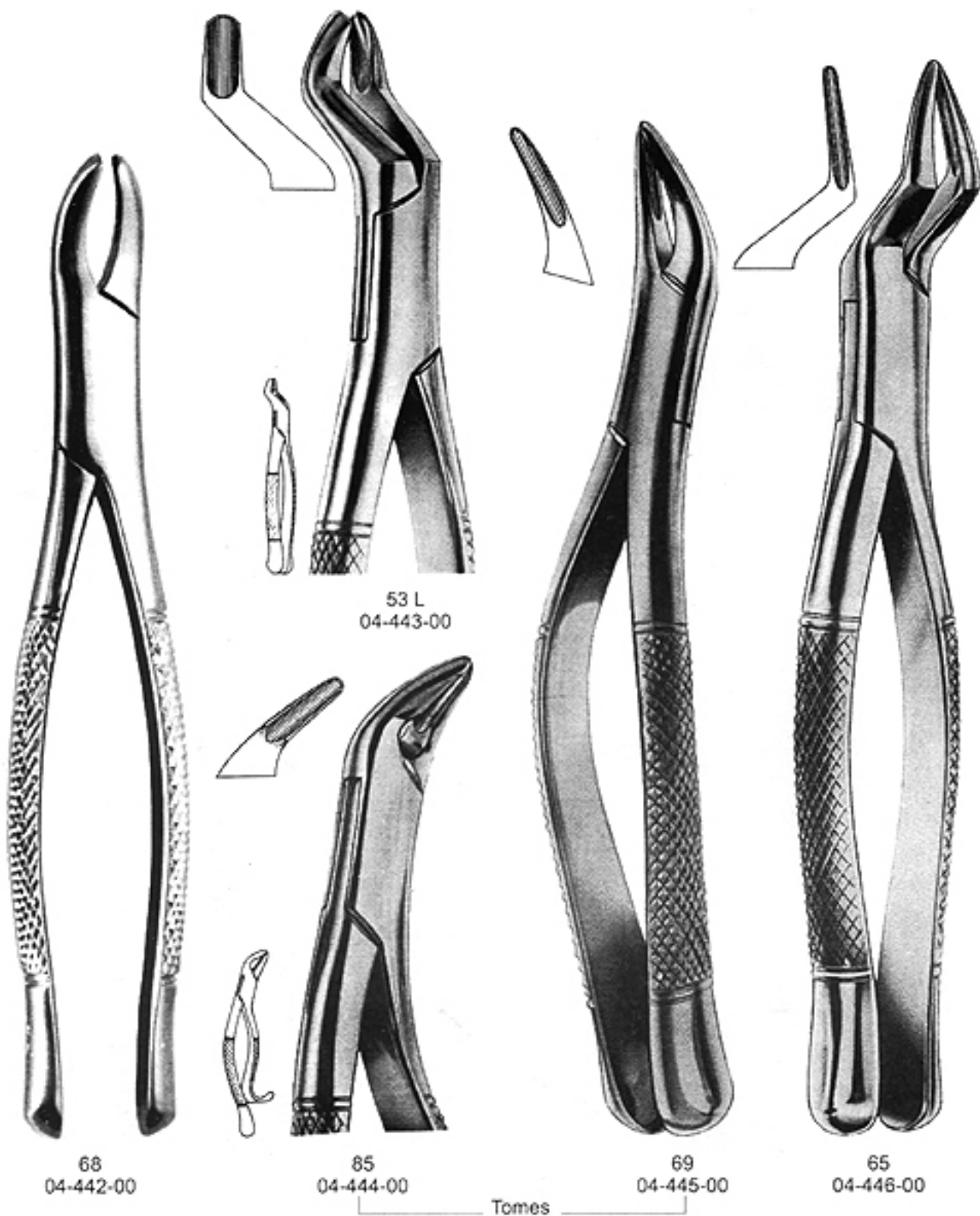



EXTRACTING FORCEPS, AMERICAN PATTERN
 ZAHNZANGE AMERICAN FORM
 FORCEPS DE EXTRACCION FORMA AMERICANA

04

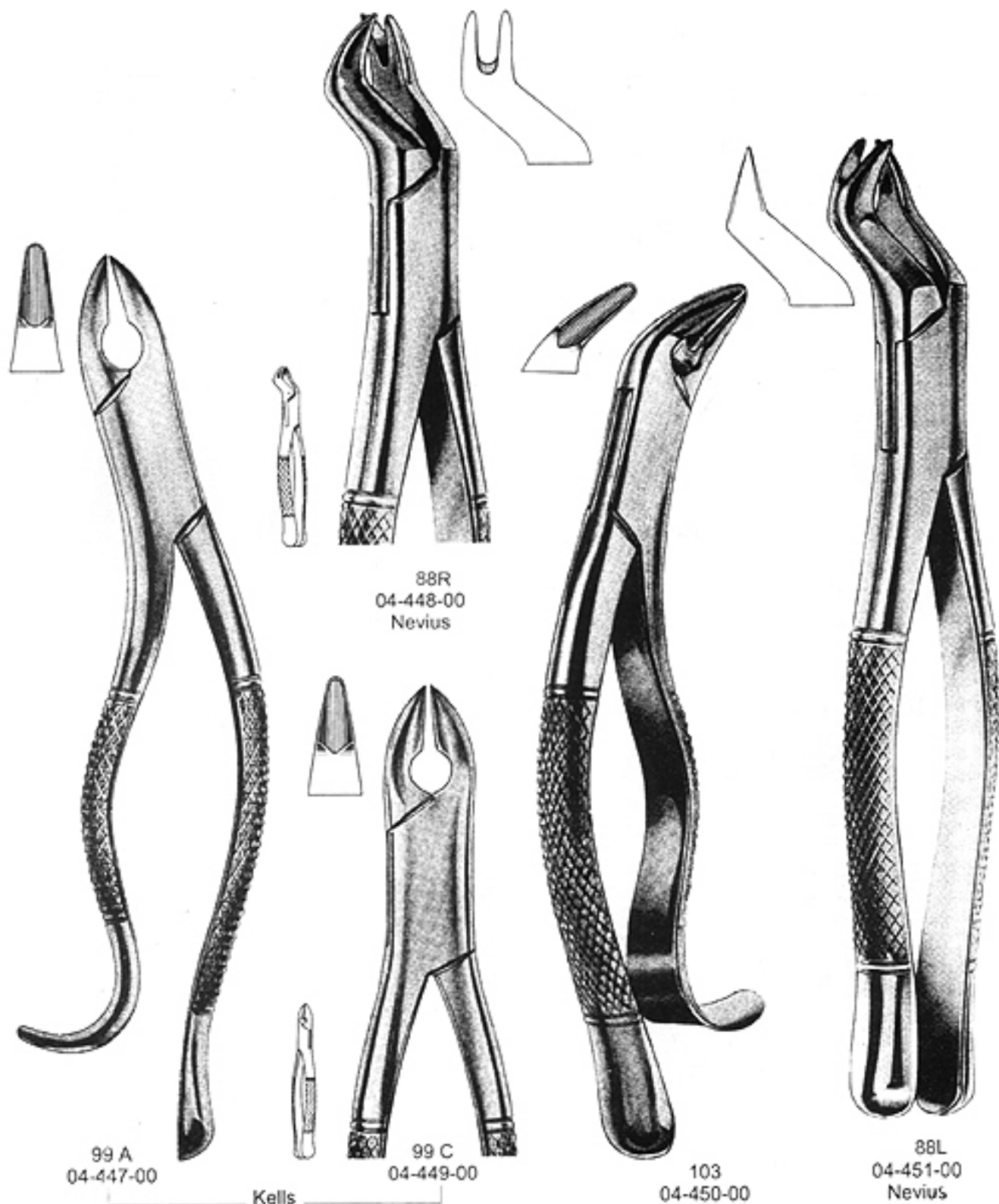

99 A
04-447-00

88R
04-448-00
Nevius

99 C
04-449-00

103
04-450-00

88L
04-451-00
Nevius

Kells

EXTRACTING FORCEPS, AMERICAN PATTERN
 ZAHNZANGE AMERICAN FORM
 FORCEPS DE EXTRACCION FORMA AMERICANA



ARAIN

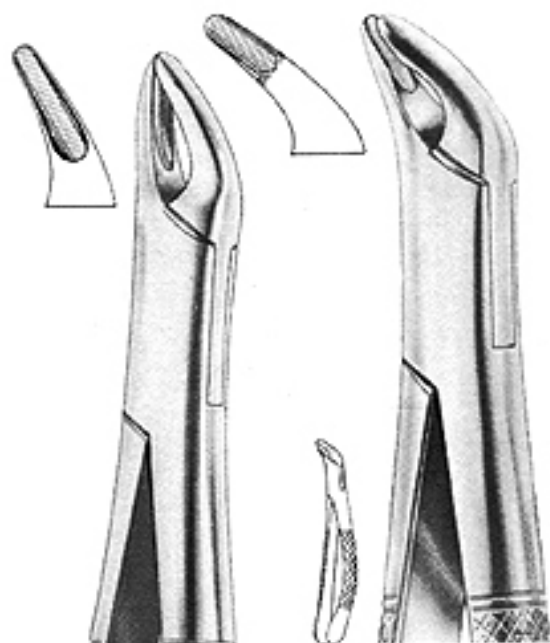

150 A
 04-453-00

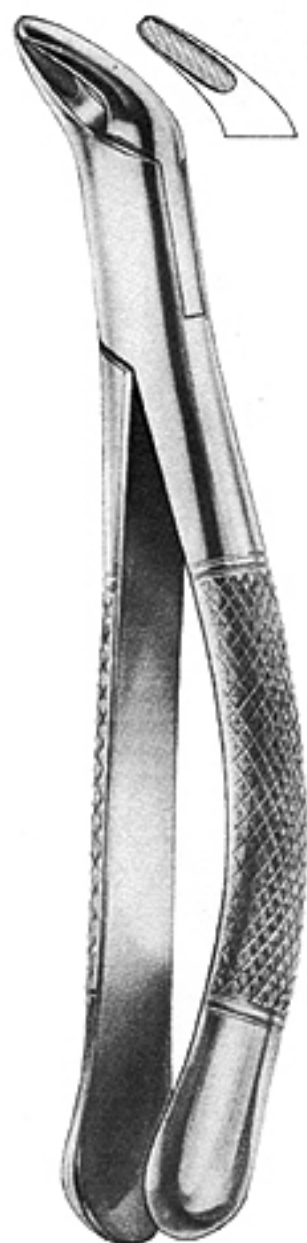

151
 04-455-00

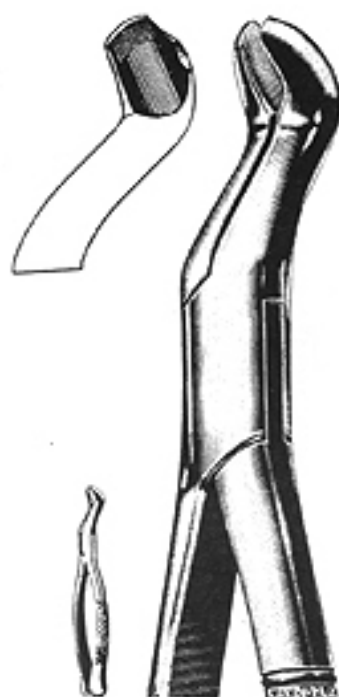

121
 04-456-00

150 S
 04-452-00

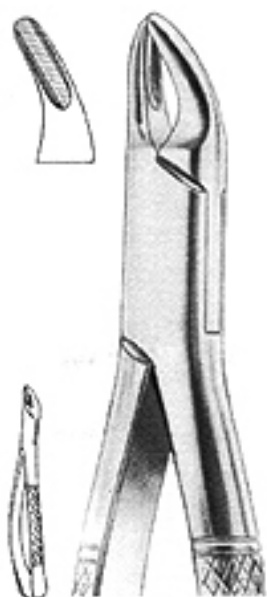

150
 04-454-00
 cryer

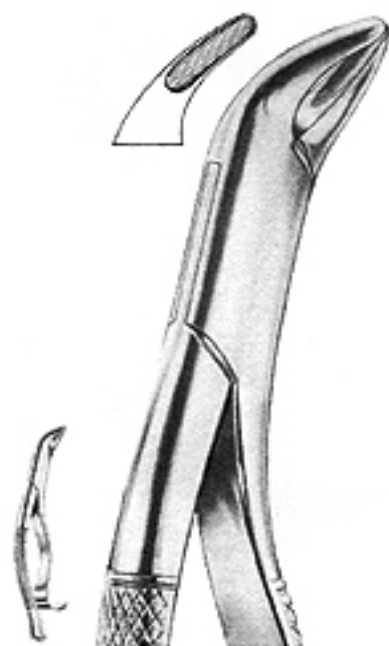

103
 04-457-00



EXTRACTING FORCEPS, AMERICAN PATTERN
ZAHNZANGEN AMERICAN FORM
FORCEPS DE EXTRACCION FORMA AMERICANA

04

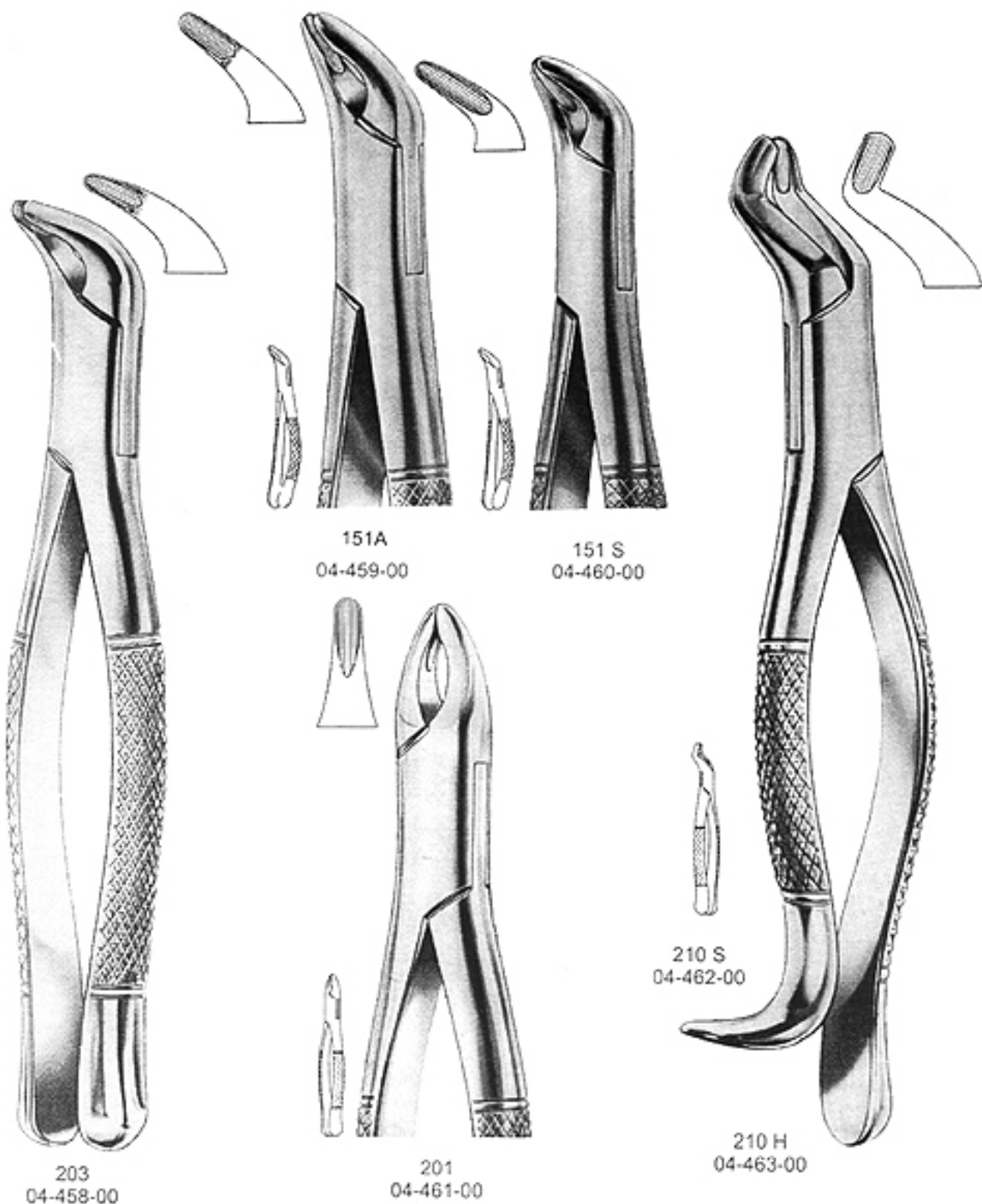

EXTRACTING FORCEPS, AMERICAN PATTERN
 ZAHNZANGE AMERICAN FORM
 FORCEPS DE EXTRACCION FORMA AMERICANA



ARAIN

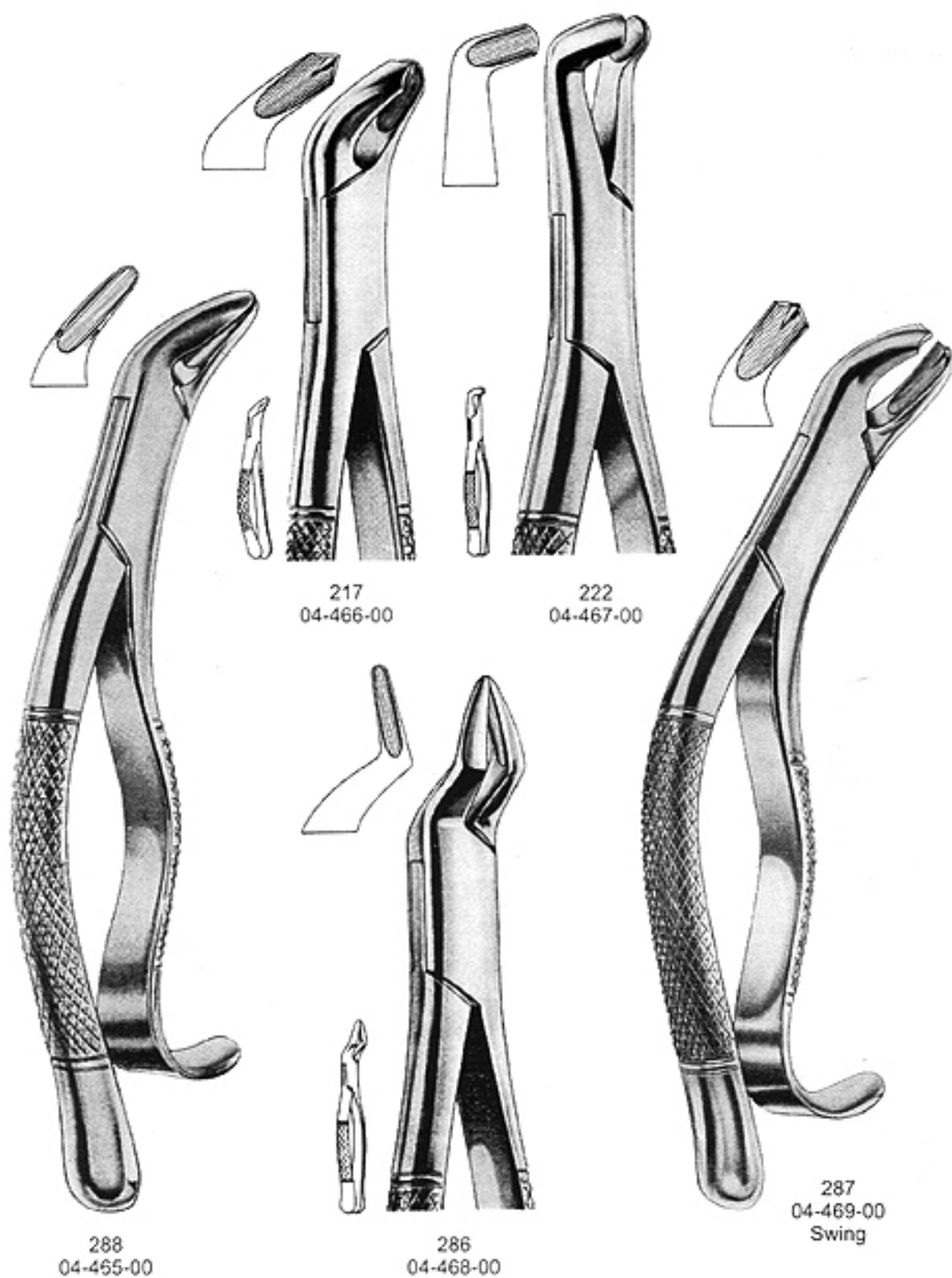



ARAIN

EXTRACTING FORCEPS, AMERICAN PATTERN
ZAHNZANGEN AMERICAN FORM
FORCEPS DE EXTRACCION FORMA AMERICANA

04

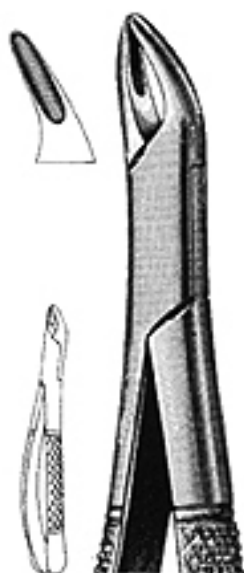

150 S
04-470-00

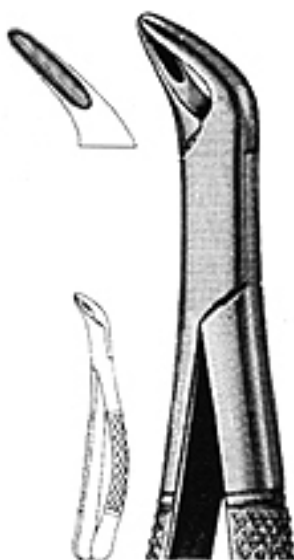

151 S
04-471-00

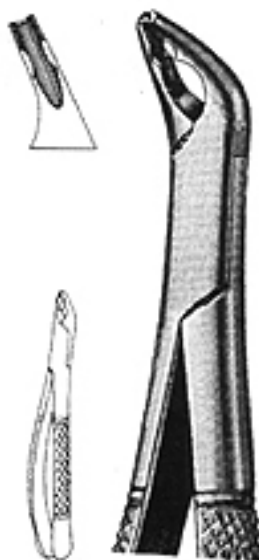

151 XAS
04-473-00

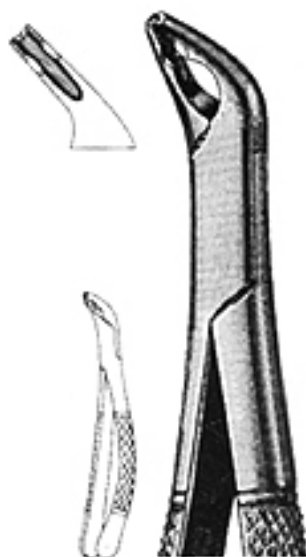

151 XAS
04-473-00

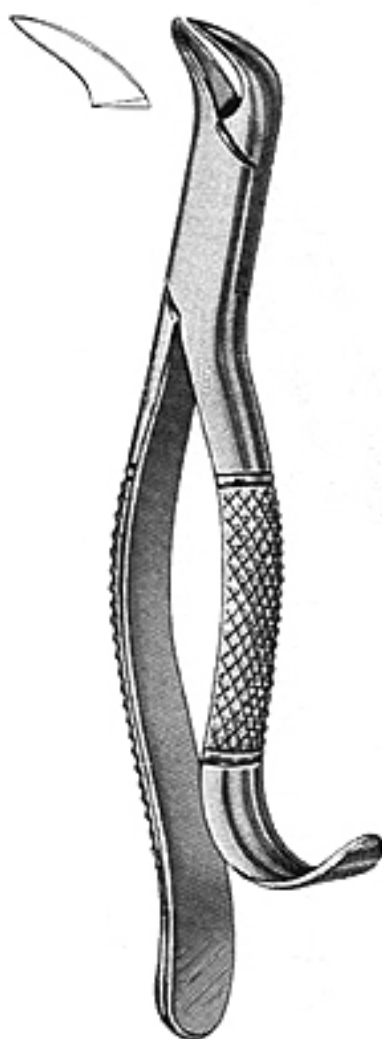

16 S
04-474-00

EXTRACTING FORCEPS, AMERICAN PATTER
 ZAHNZANGE AMERICAN FORM
 FORCEPS DE EXTRACCION FORMA AMERICANA



ARAIN



17 SK
 04-475-00



23 SK
 04-477-00

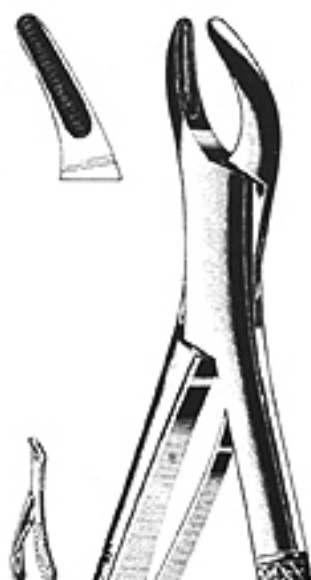

150 SK
 04-476-00



151 SK
 04-478-00



ROOT FRAGMENT FORCEPS
WURZELSPLITZERZANGEN
FORCEPS PARA FRAGMENTOS DE RAICES

04

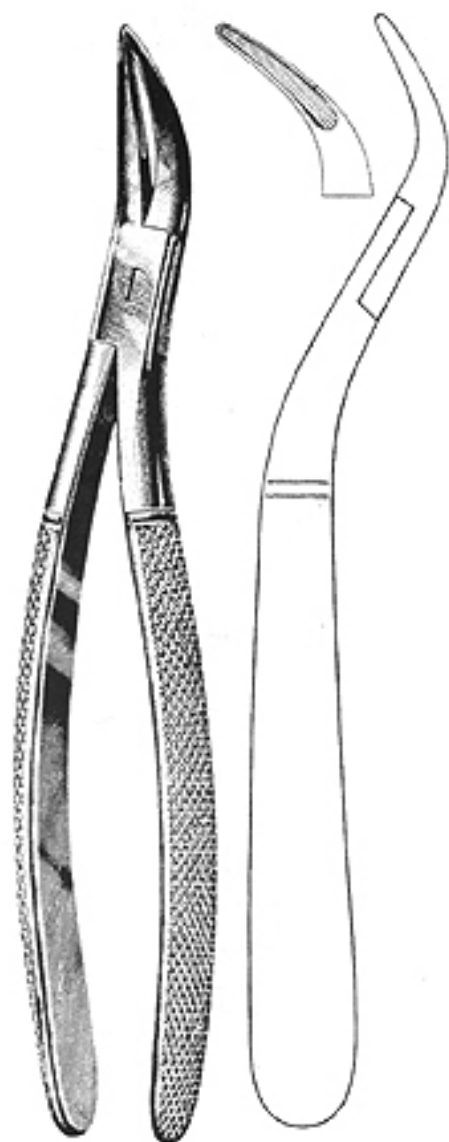

04-529-00

Witzel

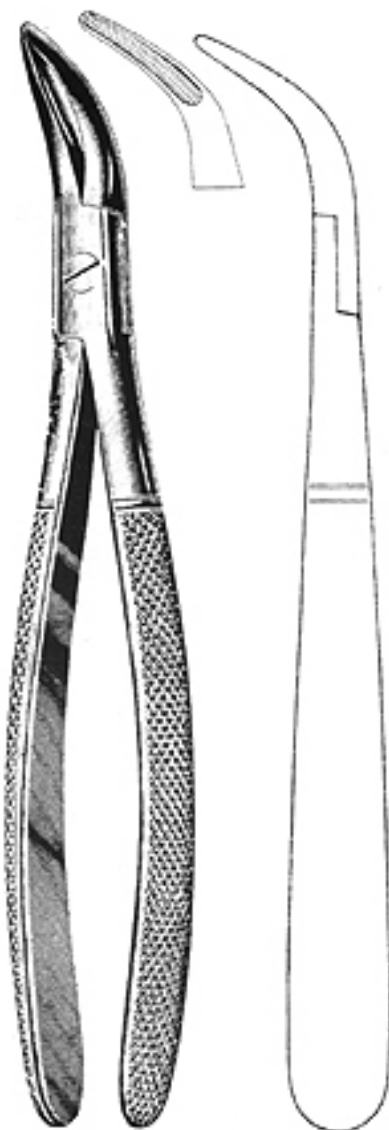

04-530-00



04-531-16
16.5 cm
Brom-Allen



04-532-16
16 cm
Albrecht



04-533-16
16 cm



**WITH DIAMOND
 DUST COATING**



1
 04-584-00



99
 04-585-00



04-586-00

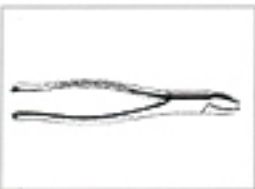

EXTRACTING FORCEPS, AMERICAN PATTERN
ZAHNZANGEN AMERICAN FORM
FORCEPS DE EXTRACCION FORMA AMERICANA

04

**WITH DIAMOND
DUST COATING**

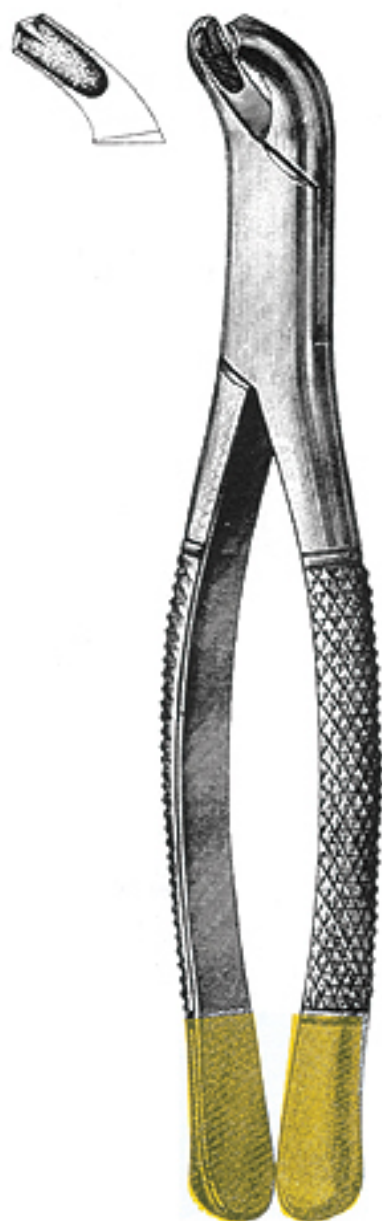

17
04-587-00

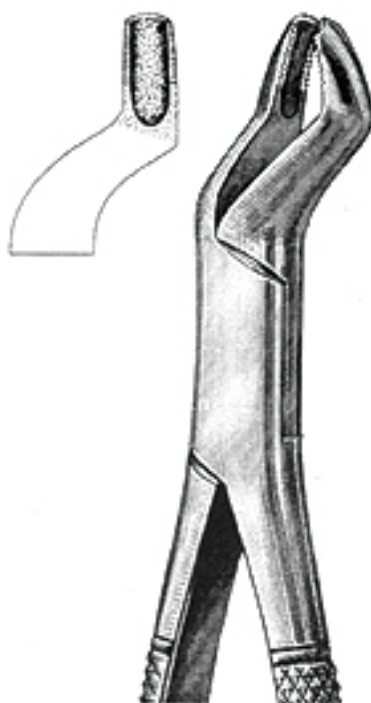

53 L
04-588-00

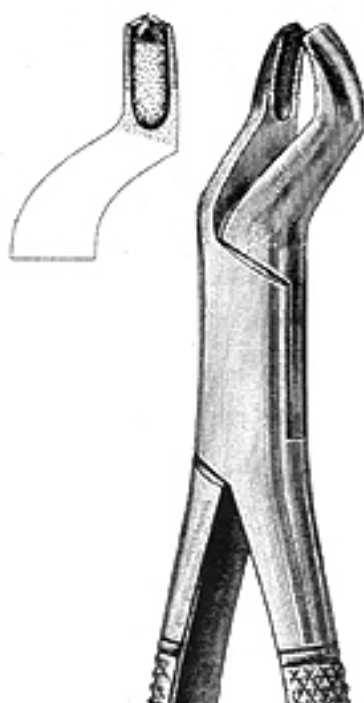

53 R
04-589-00

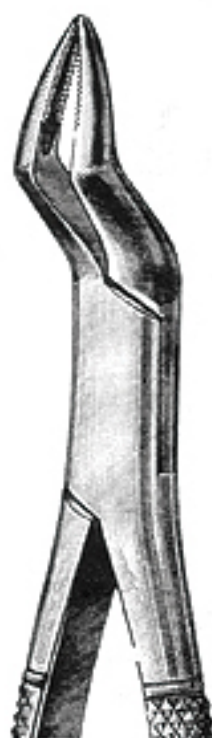

65
04-590-00

M.A. ARAIN & BROTHERS (PVT.) LTD.

103



WITH DIAMOND DUST COATING

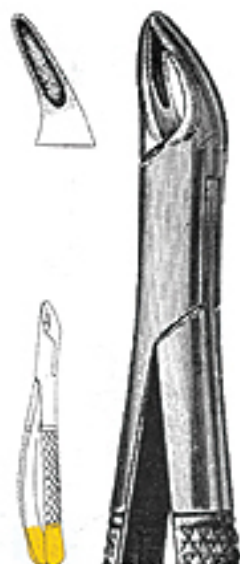

150 S
 04-591-00

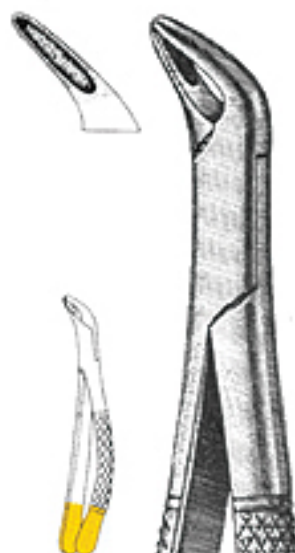

151 S
 04-592-00

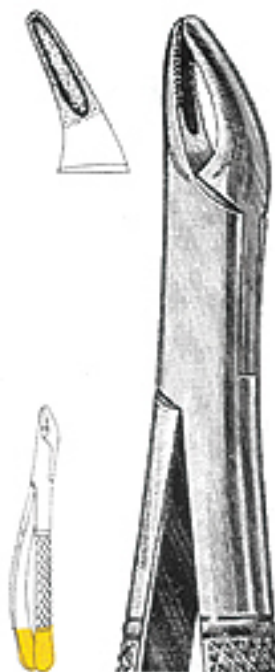

150
 04-593-00

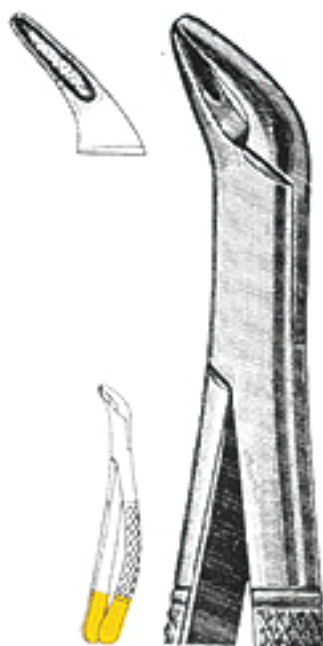

151
 04-594-00

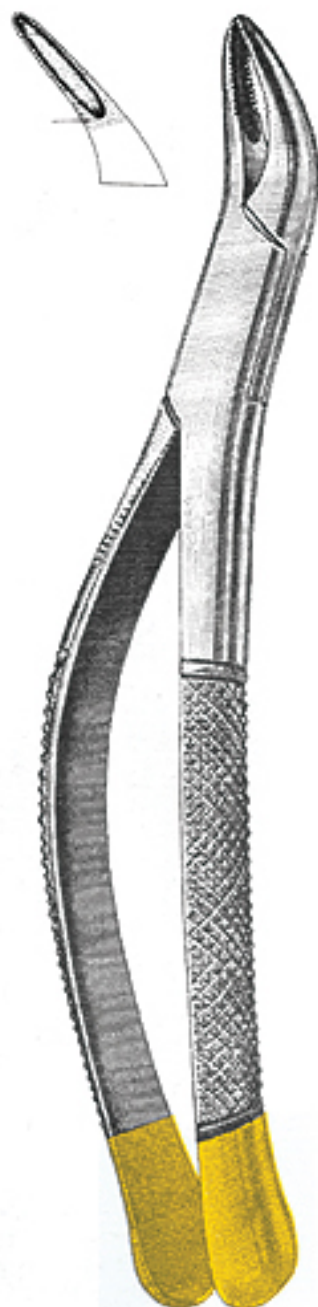

69
 04-595-00

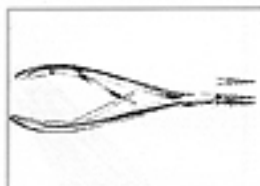

ARAIN

SPLINTER FORCEPS
PINCES A FRAGMENTOS
PINZAS PARA FRAGMENTOS

04

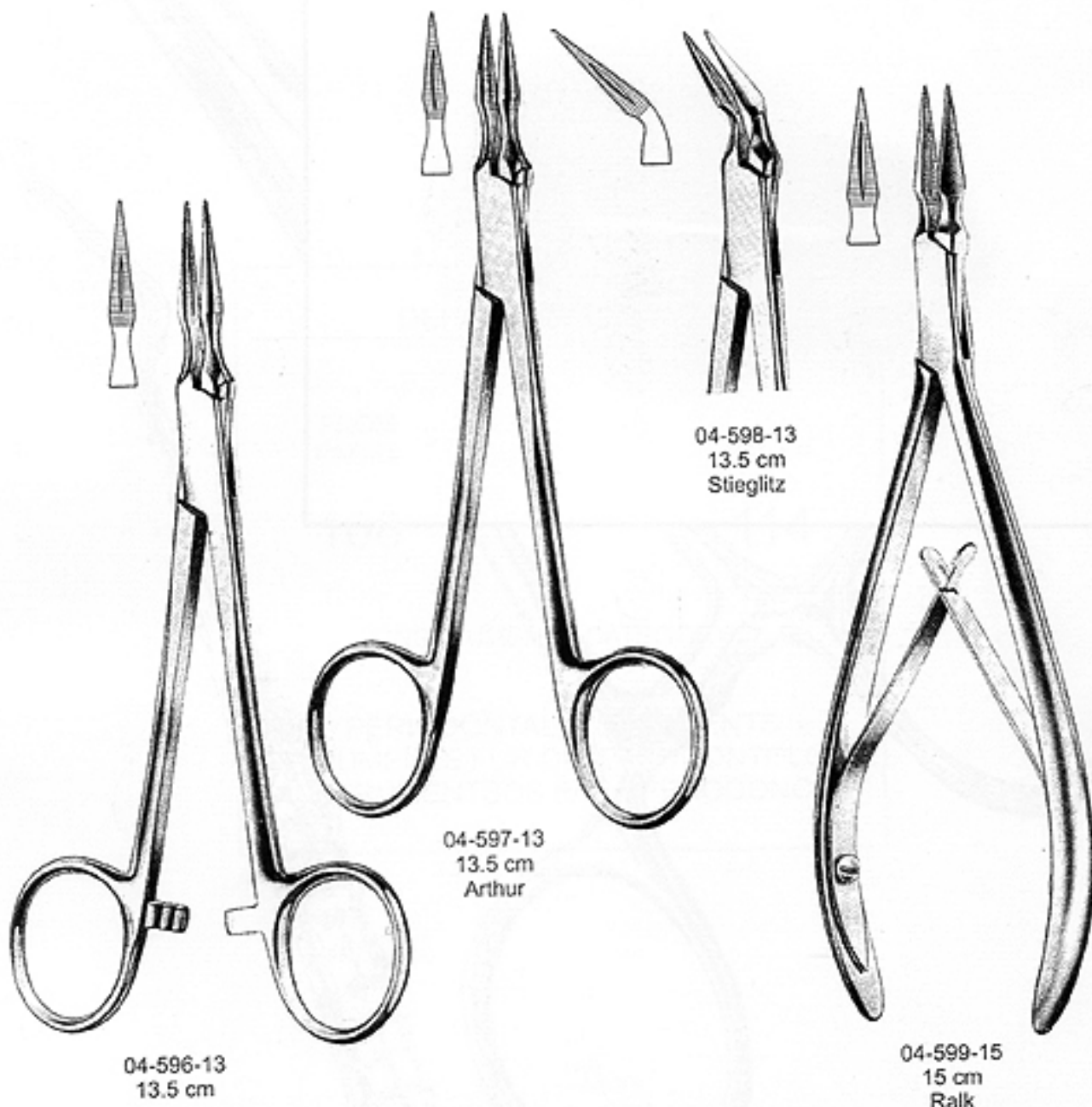

Department

05

PERIODONTAL INSTRUMENTS
INSTRUMENTE FÜR DIE PARODONTOLOGIE
INSTRUMENTSOS PARA PERODONCIA

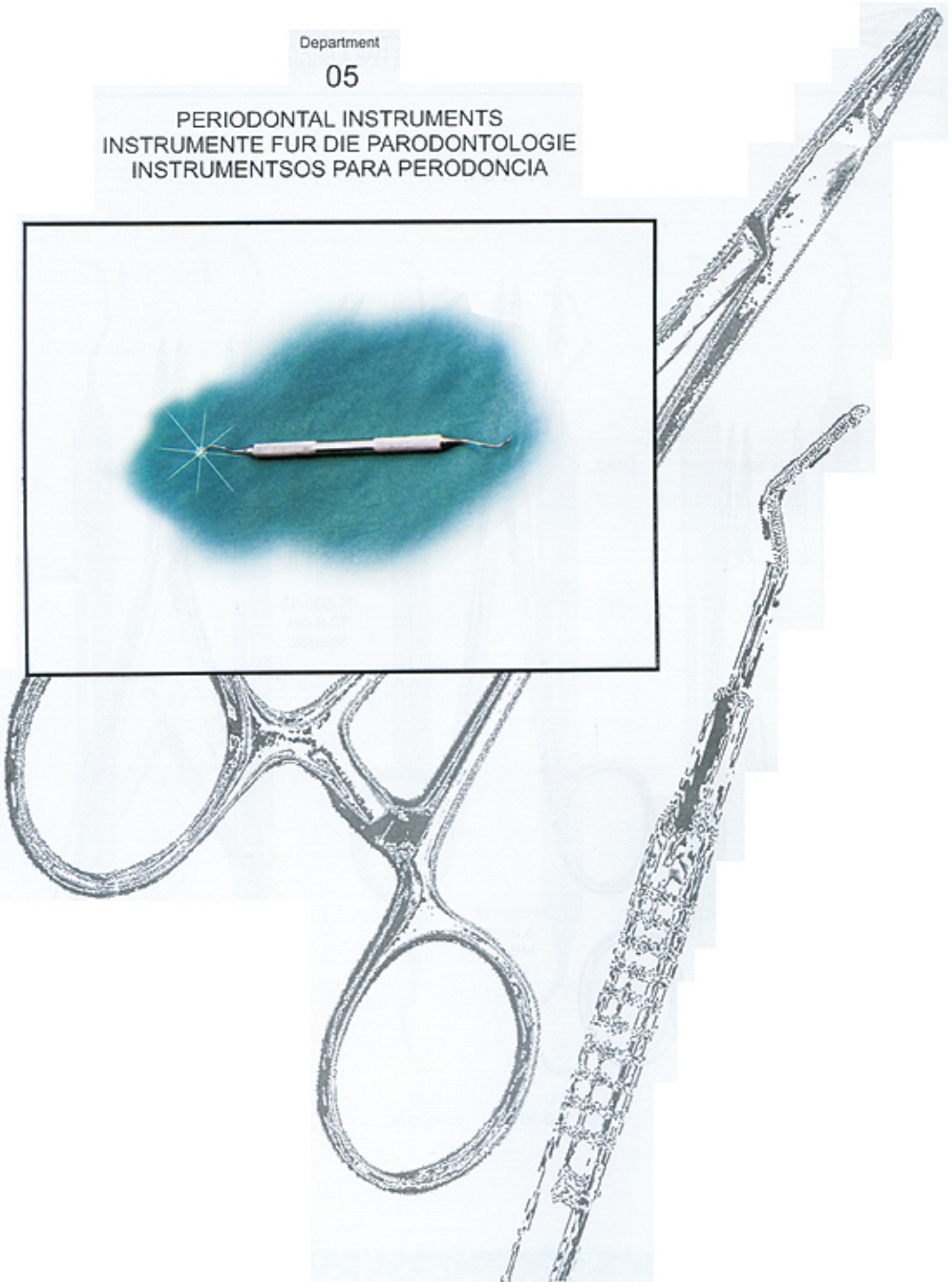
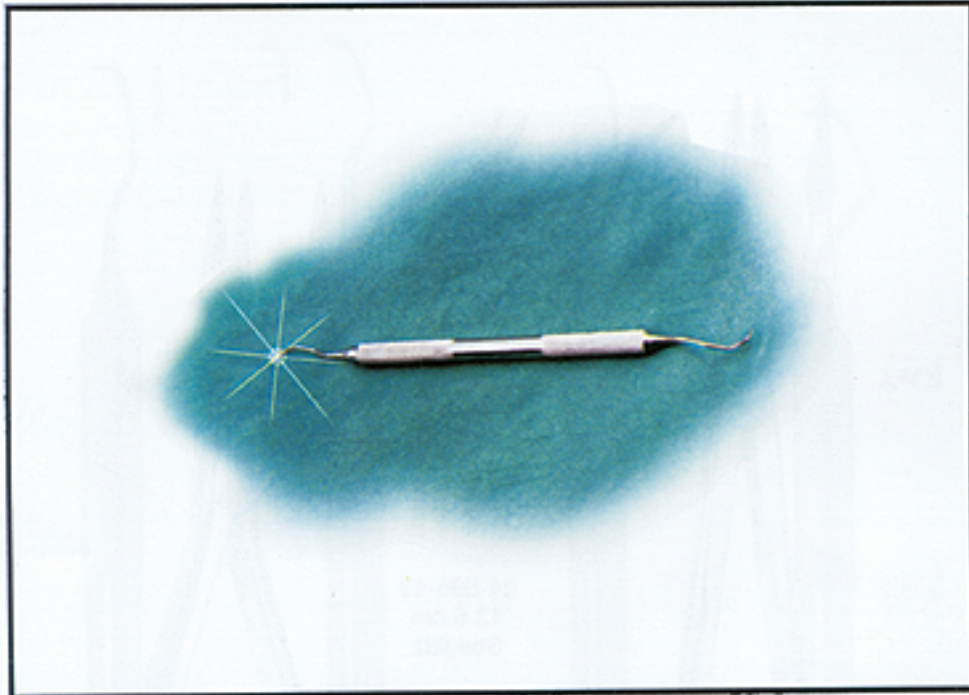

DEPARTMENT NO. 5

FROM
PAGE#

106

TO
PAGE#

114

INSTRUMENTS CATEGORY

PERIODONTAL INSTRUMENTS
INSTRUMENTE FÜR DIE PARODONTOLOGIE
INSTRUMENTSOS PARA PERODONCIA



HANDLE SELECTION GUIDE
GRIFFE SIND AUSWAHLBAR
MANGO CHOICE



AA

AA
 OCTA-Classic
 Solid handle Ø5.5 mm



BB

BB
 SLIM-Action
 Solid handle Ø6 mm



CC

CC
 COBRA-Series
 Hollow handle Ø8 mm



DD

DD
 RING-O-Lite
 Hollow handle Ø8 mm



EE

EE
 FEATHER Feel
 Hollow handle Ø8 mm



FF

FF
 SOFTHOLD
 Hollow handle Ø8 mm



GG

GG
 MAX GRIP
 (For detail: Please read catalogue page no. 133)

NOTE: Any one of the above handles can be choosed for hand instruments just by given reference of any required HANDLE.

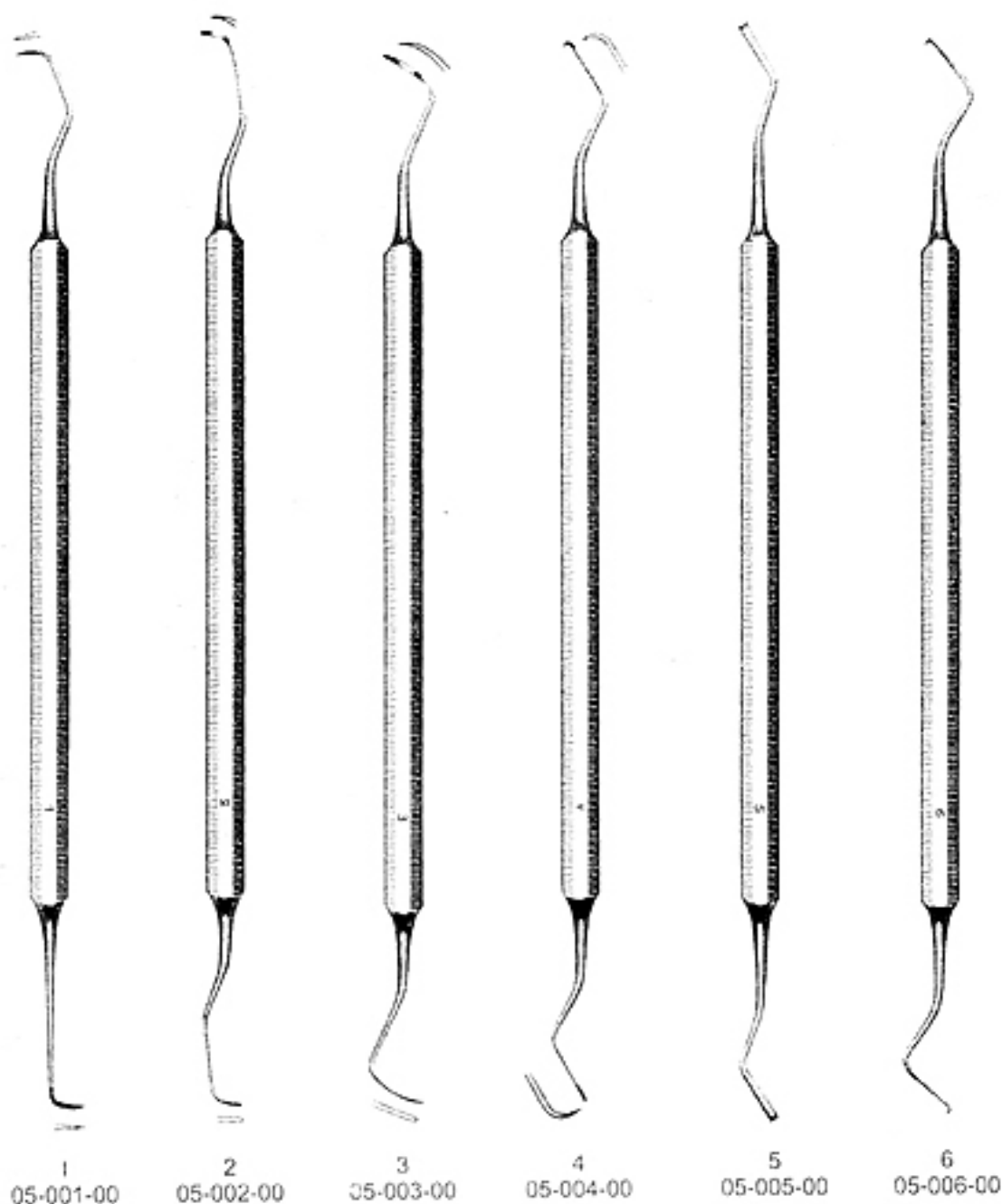



7
05-007-00



8
05-008-00



9
05-009-00



10
05-010-00



11
05-011-00

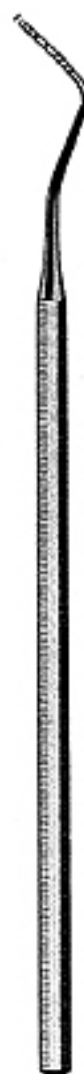

05-012-00

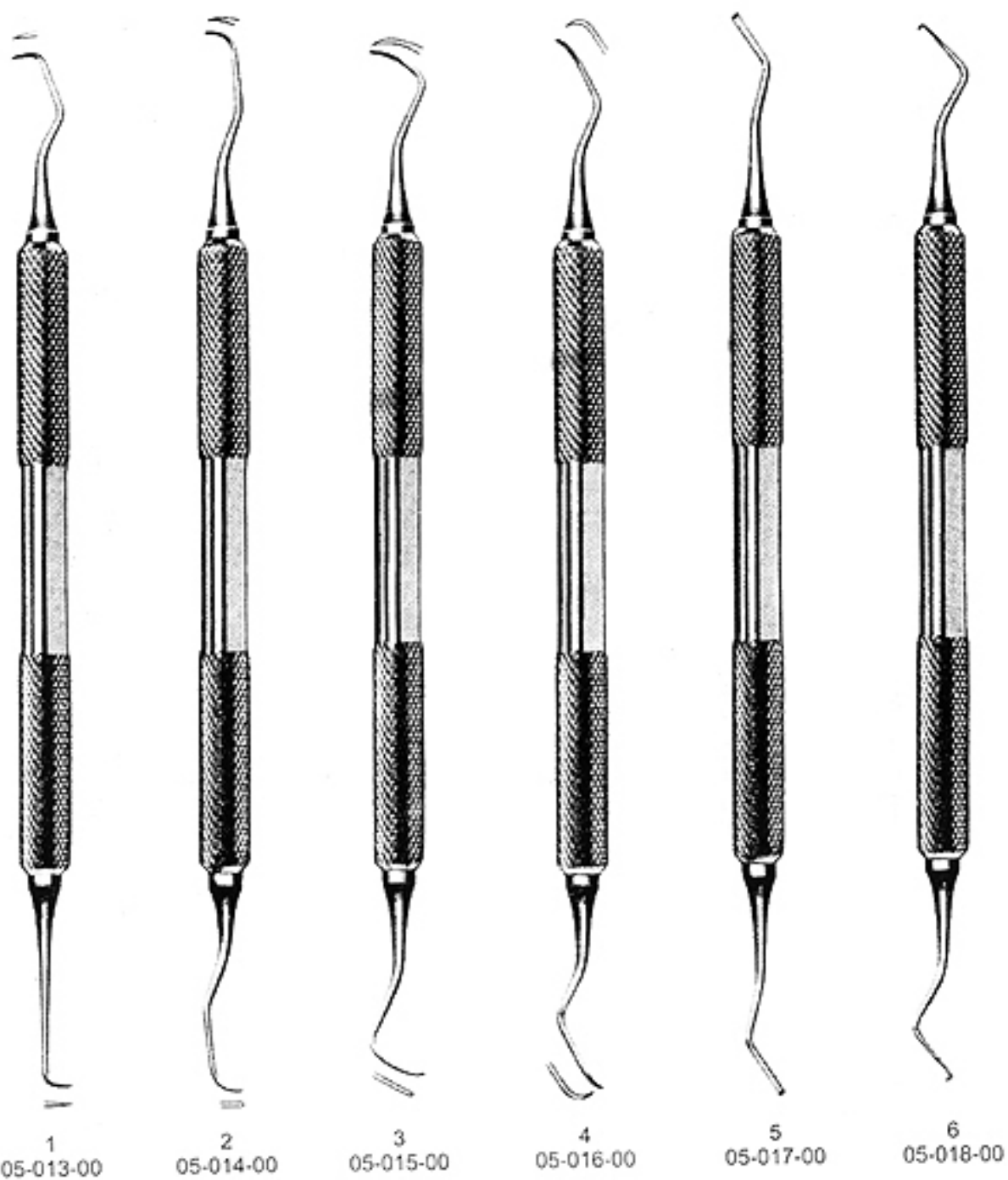



PERIODONTAL INSTRUMENTS
INSTRUMENTE FÜR DIE PARODONTOLOGIE
INSTRUMENTSOS PARA PERODONCIA

05

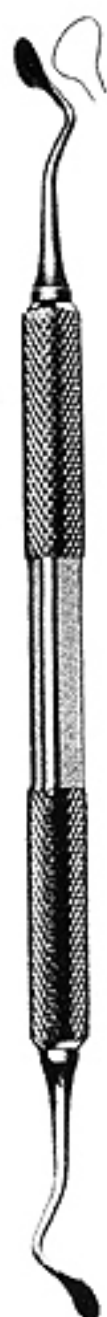

7
05-019-00

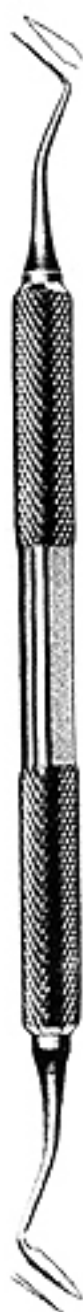

8
05-020-00

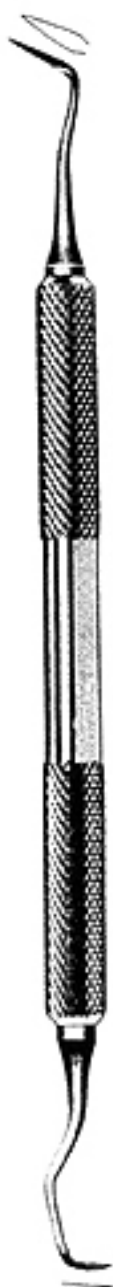

9
05-021-00



10
05-022-00

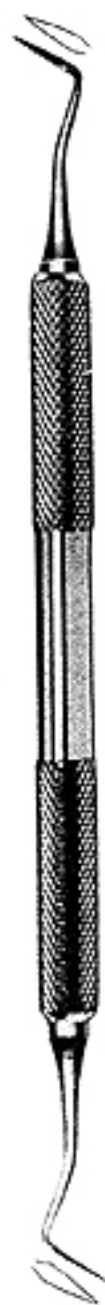

11
05-023-00



1-2
 05-024-00
 Subgingival



3-4
 05-025-00

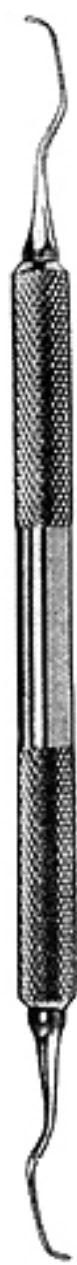

5-6
 05-026-00

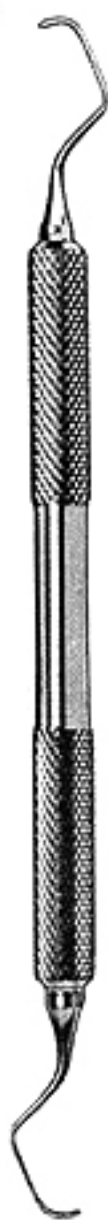

7-8
 05-027-00

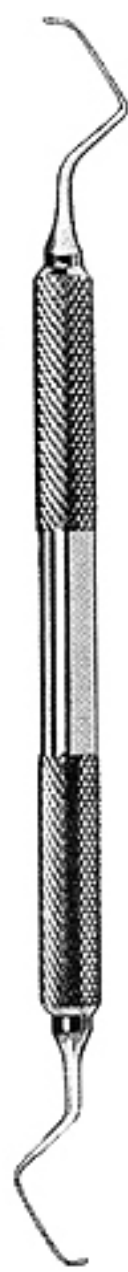

9-10
 05-028-00

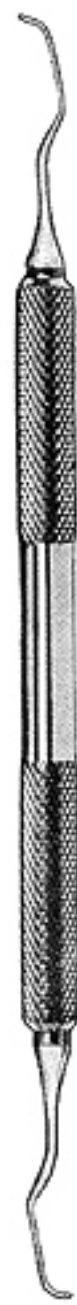

11-12
 05-029-00



PERIODONTAL INSTRUMENTS
INSTRUMENTE FÜR DIE PARODONTOLOGIE
INSTRUMENTSOS PARA PERODONCIA

05



13-14
05-030-00

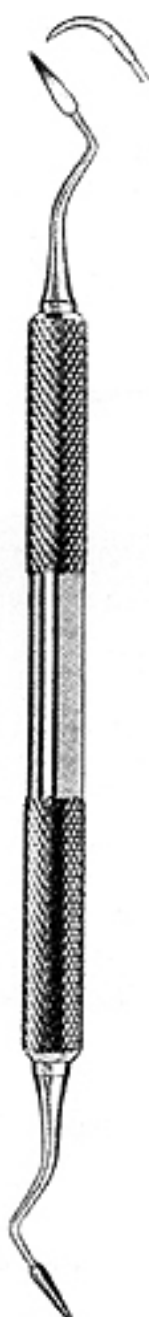

CK 6
05-031-00
Crane-Kaplan

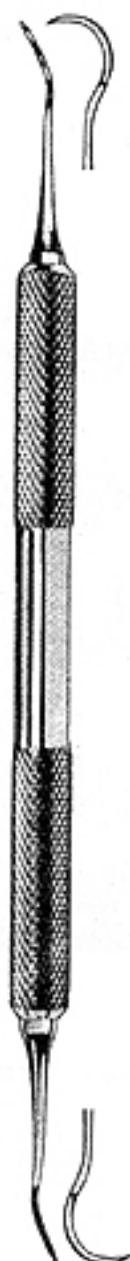

H6-H7
05-032-00

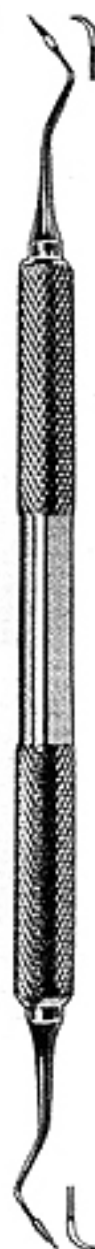

T2-T3
05-033-00
Taylor

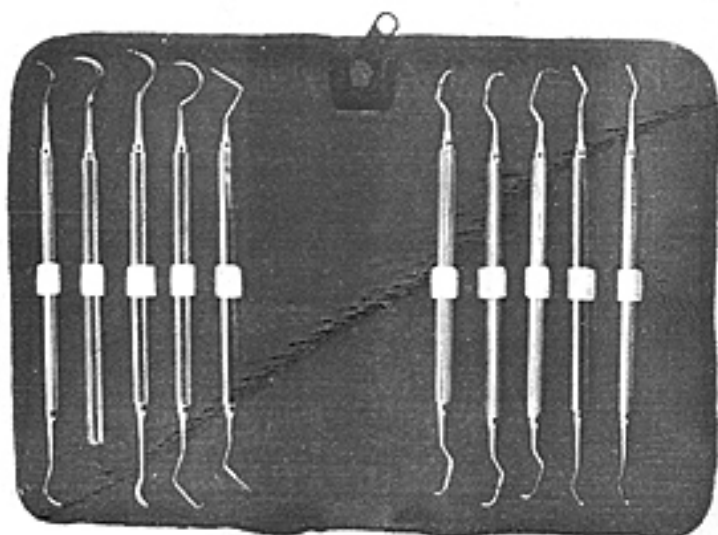

05-034-00

Subgingival Curette Set Consisting Of: 10 Pieces

- 1- Goldman fox pocket probe, double ended.
- 1- Explorer, double ended # 5
- 1- Jaquette scaler, single ended # 15
- 1- Jaquette scaler, double ended, # U 15/33
- 1- McCall curette, double ended, # 17S/18S
- 1- Langer curette, double ended # L 1/2
- 1- Langer curette, double ended # L 3/4
- 1- Langer curette, double ended # L 5/6
- 1- Periodontal curette, double ended, # H 3/7
- 1- Periodontal curette, double ended, # H 5/11



Department

06

SCALERS
ZAHNREINIGER
LIMPIADORES DE SARRO

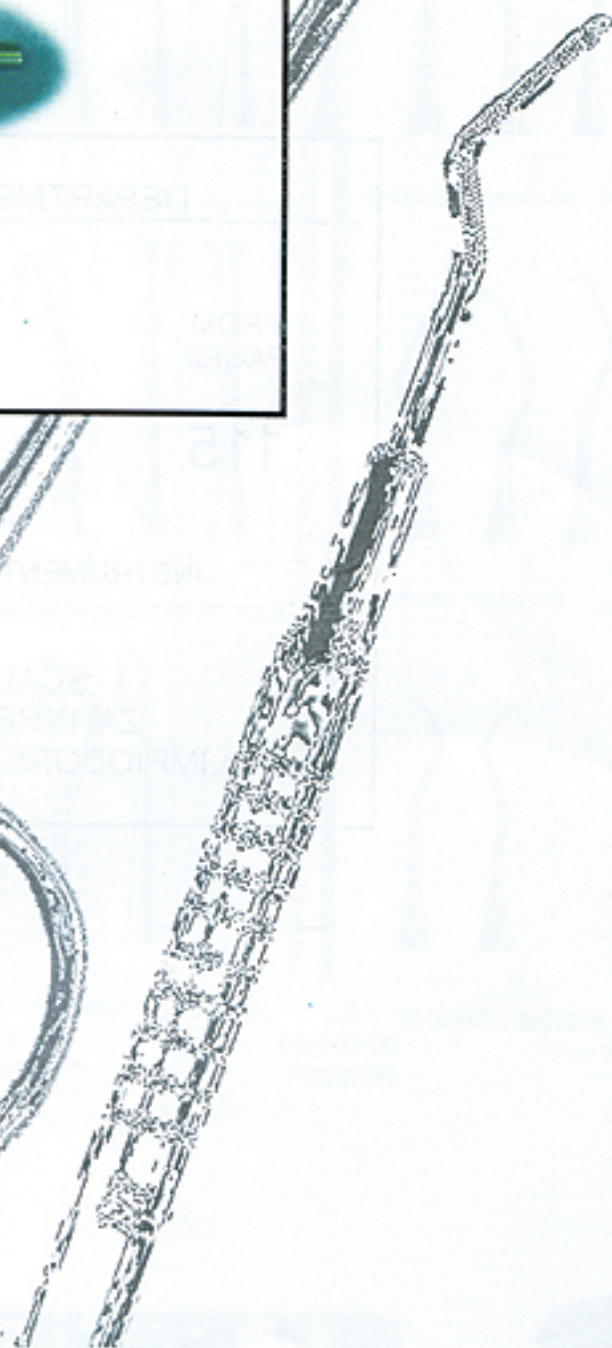
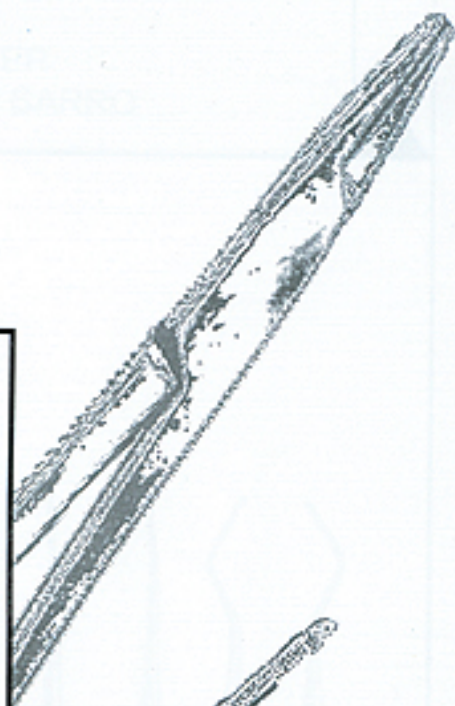
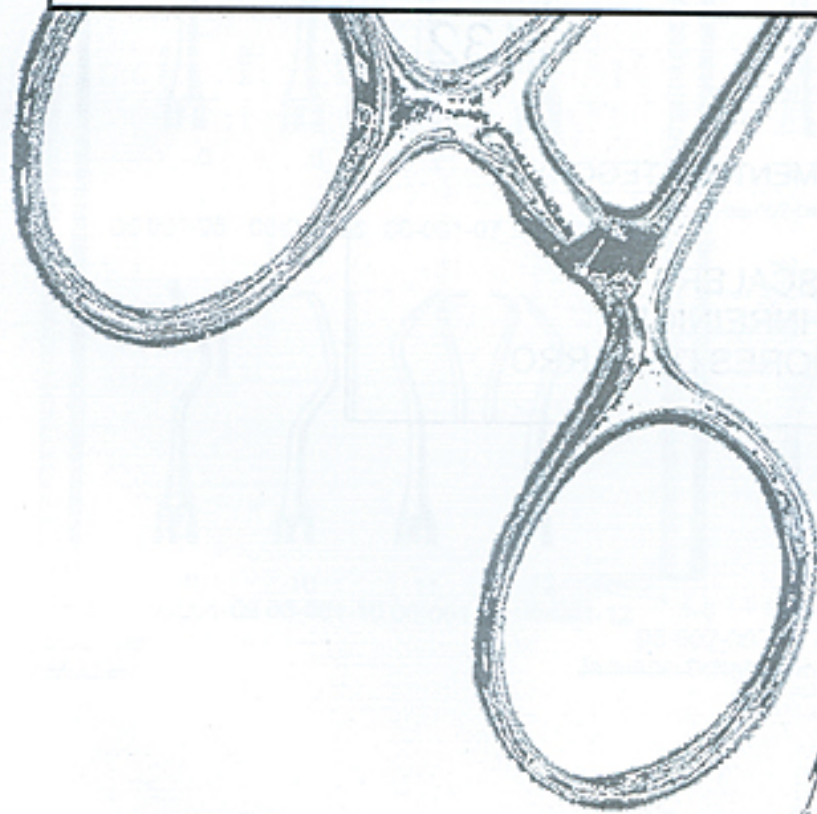
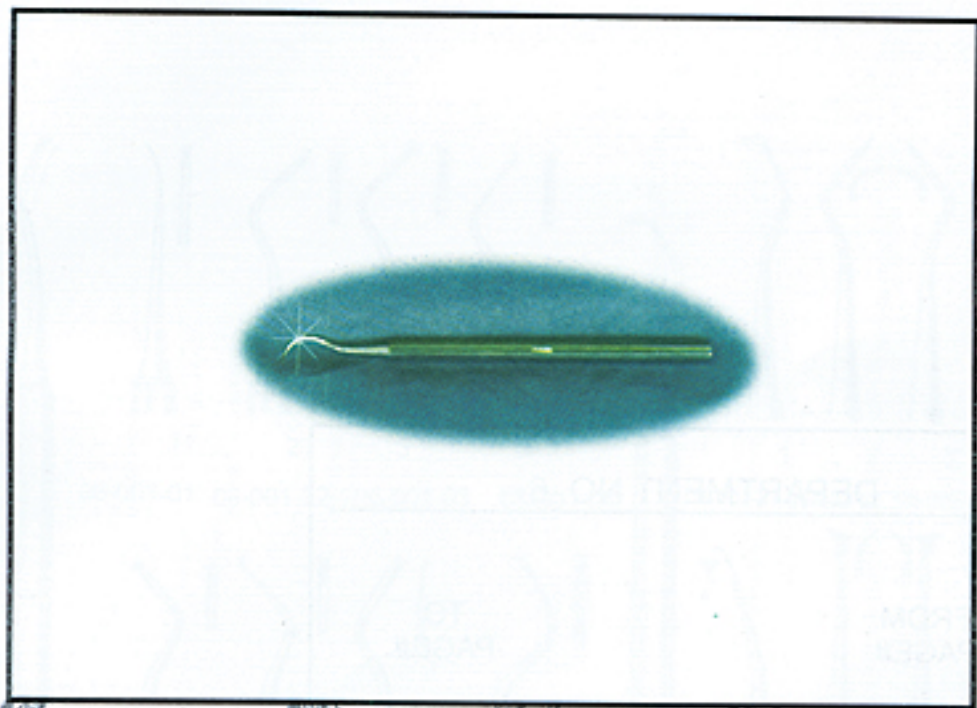

DEPARTMENT NO. 6

FROM
PAGE#

TO
PAGE#

115

132

INSTRUMENTS CATEGORY

SCALERS
ZAHNREINIGER
LIMPIADORES DE SARRO



SCALERS
ZAHNREINIGER
LIMPIODORES DE SARRO

06

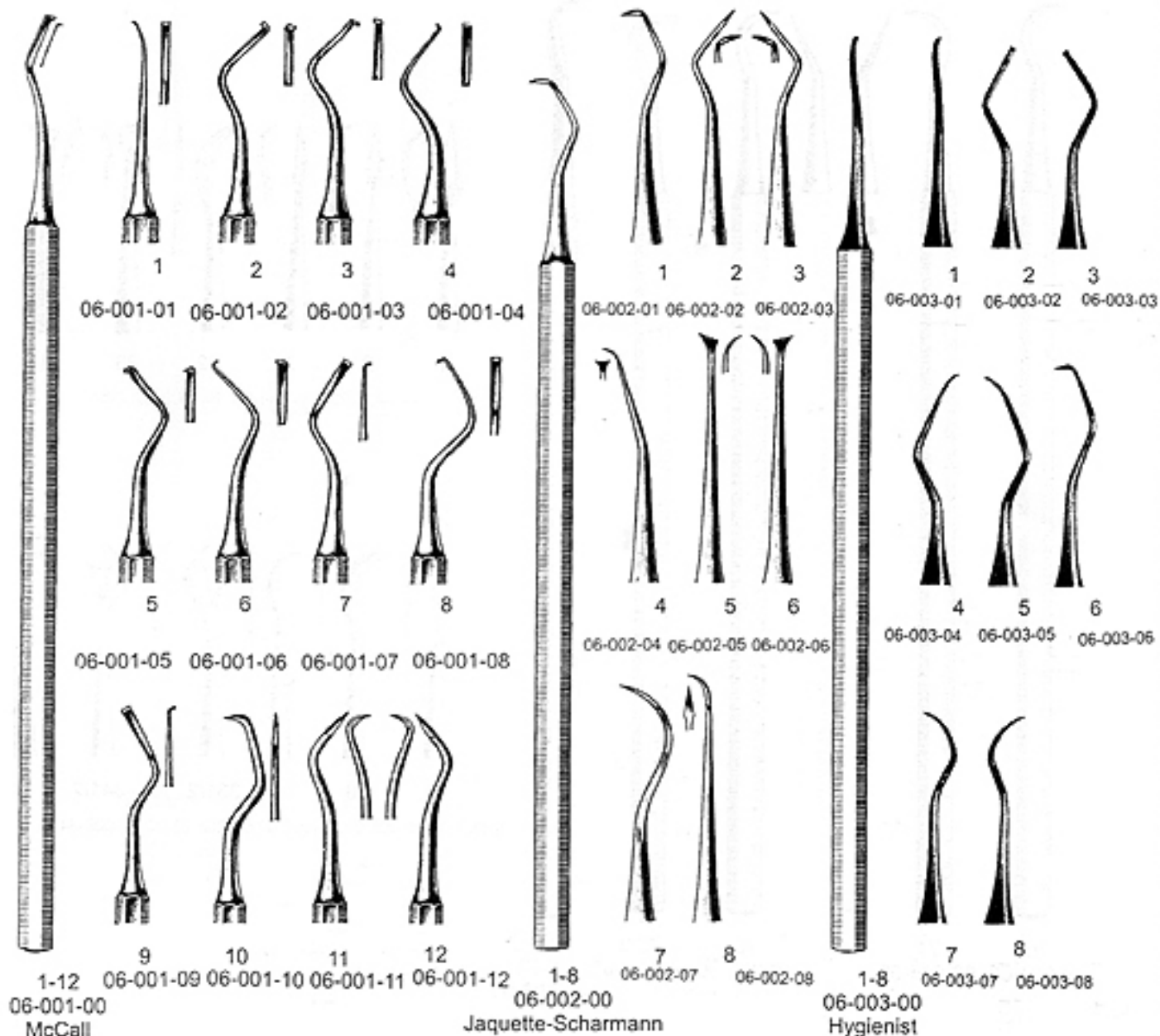

SCALERS
ZAHNREINIGER
LIMPIODORES DE SARRO

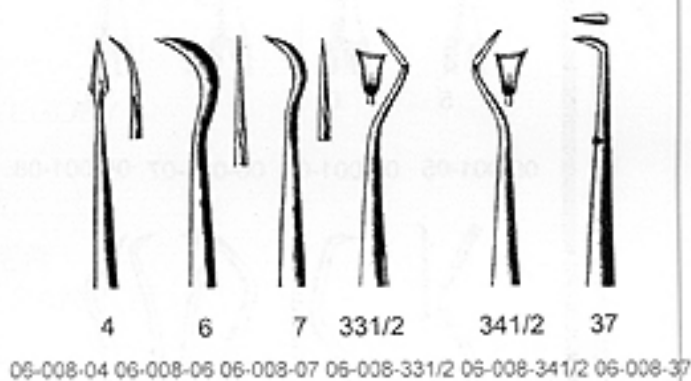
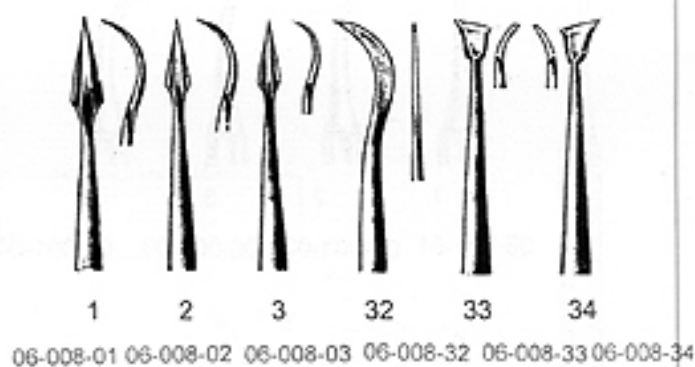
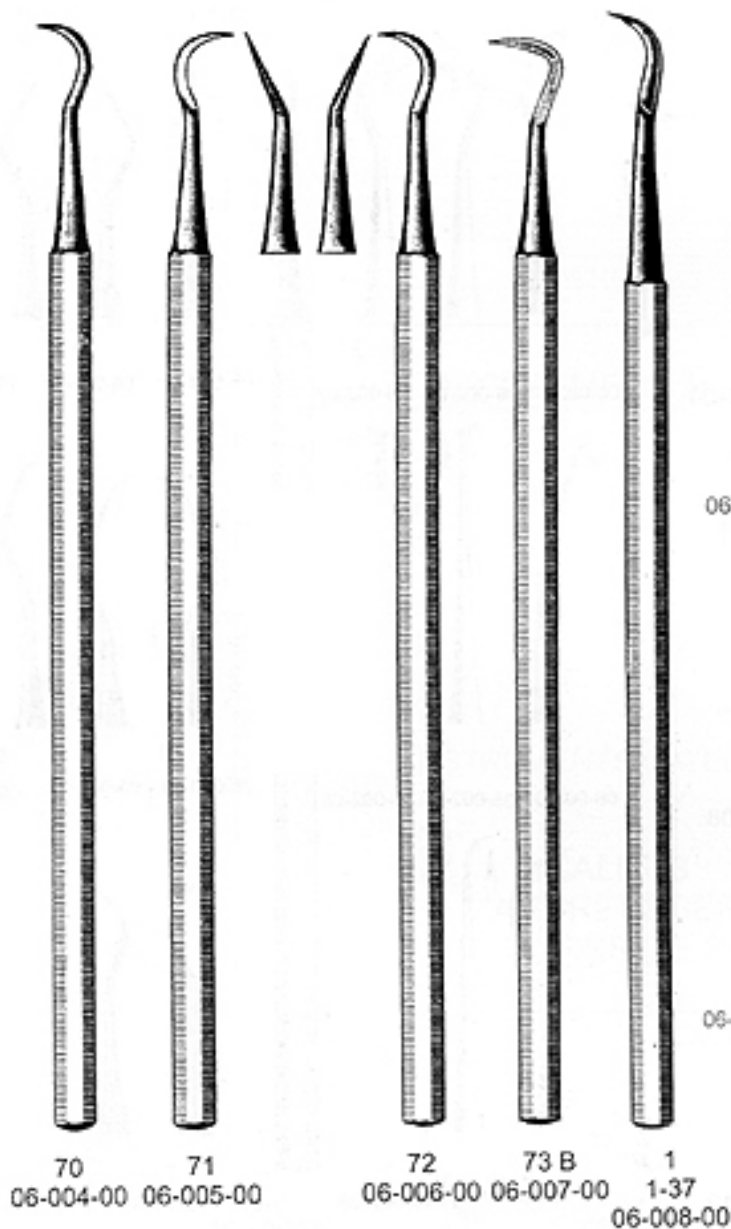

SCALERS
INSTRUMENTS A DETARTRER
LIMPIADORES DE SARRO

06

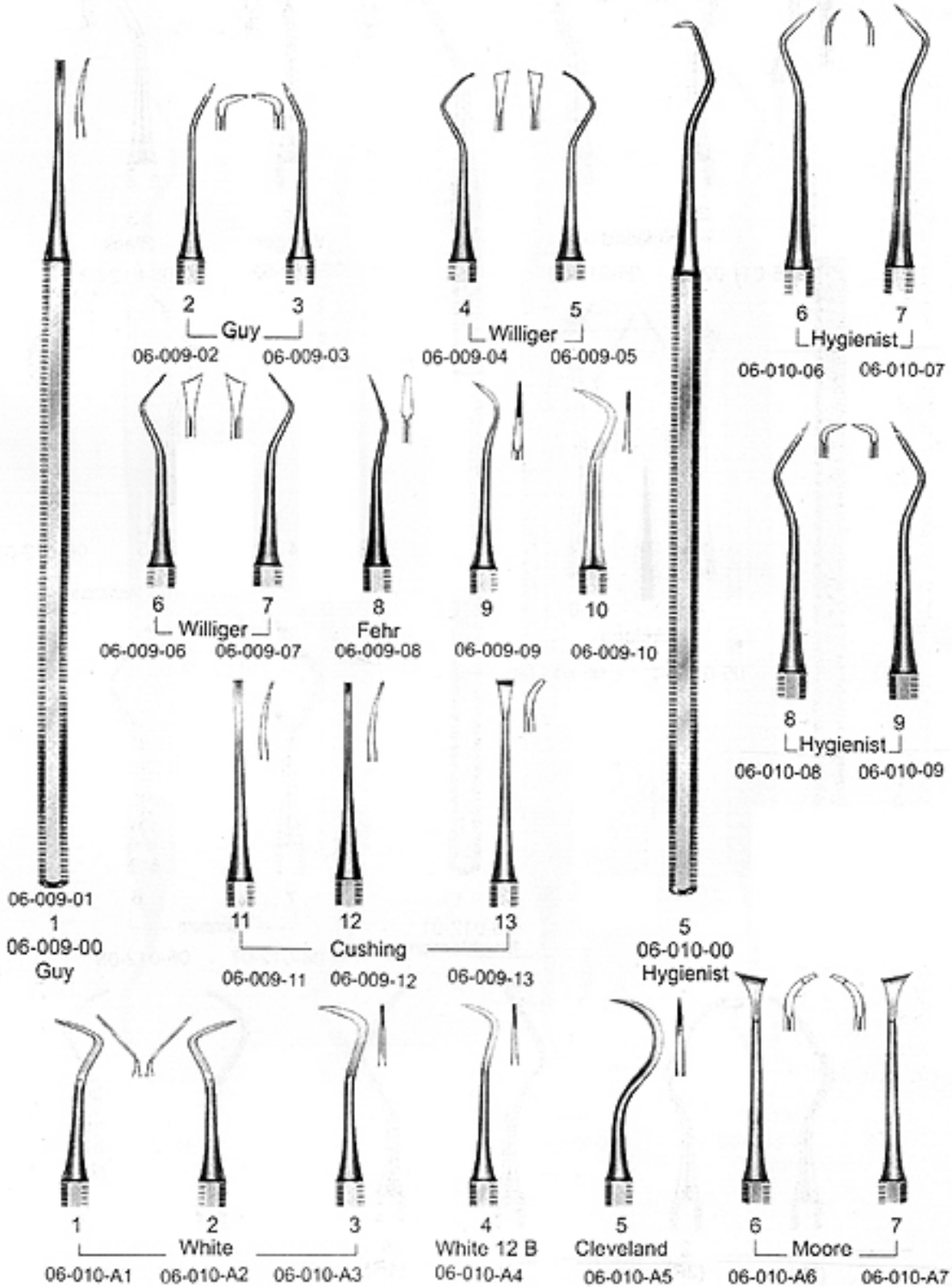

SCALERS
INSTRUMENTS A DETARTRER
LIMPIADORES DE SARRO

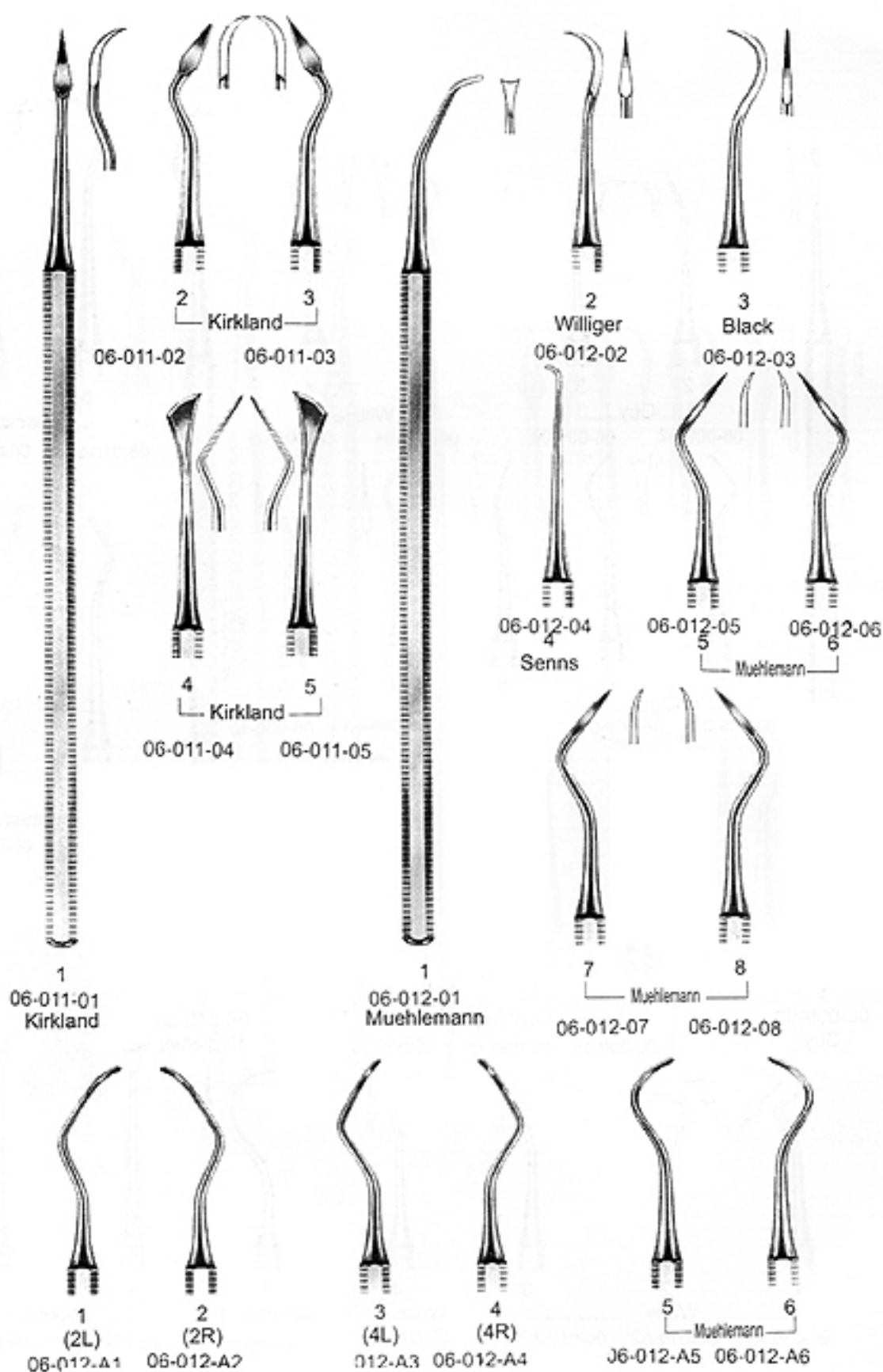

SCALERS
INSTRUMENTS A DETARTRE
LIMPIADORES DE SARRO

06



2
06-013-00



06-014-00
Cumine



06-015-00
Fher



06-016-00
White



06-017-00
Globe



06-018-00
13-14



06-019-00
77-78



06-020-00
79-80

Black

SCALERS
INSTRUMENTS A DETARTRER
LIMPIADORES DE SARRO

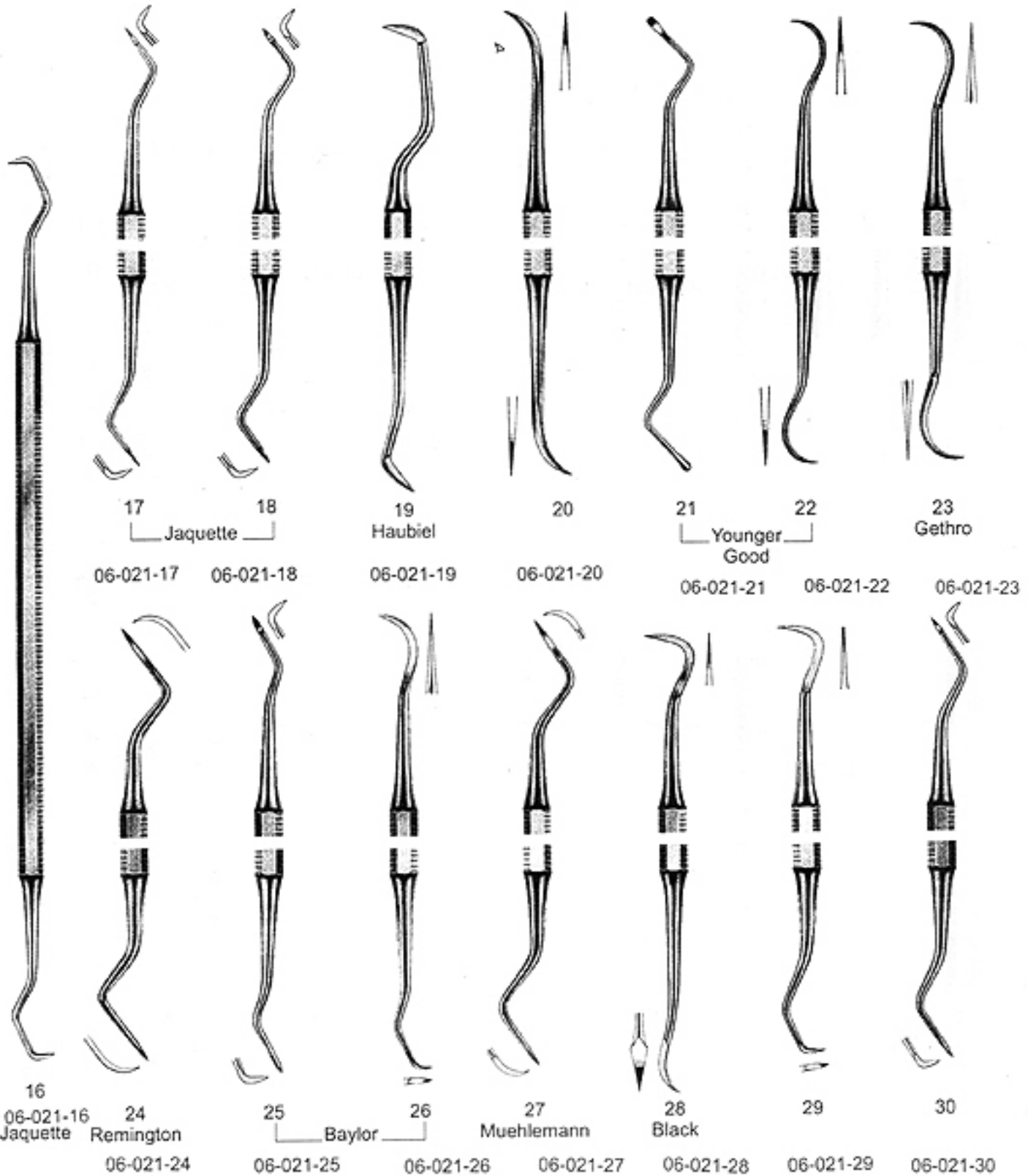

SCALERS
INSTRUMENTS A DETARTRER
LIMPIADORES DE SARRO

06

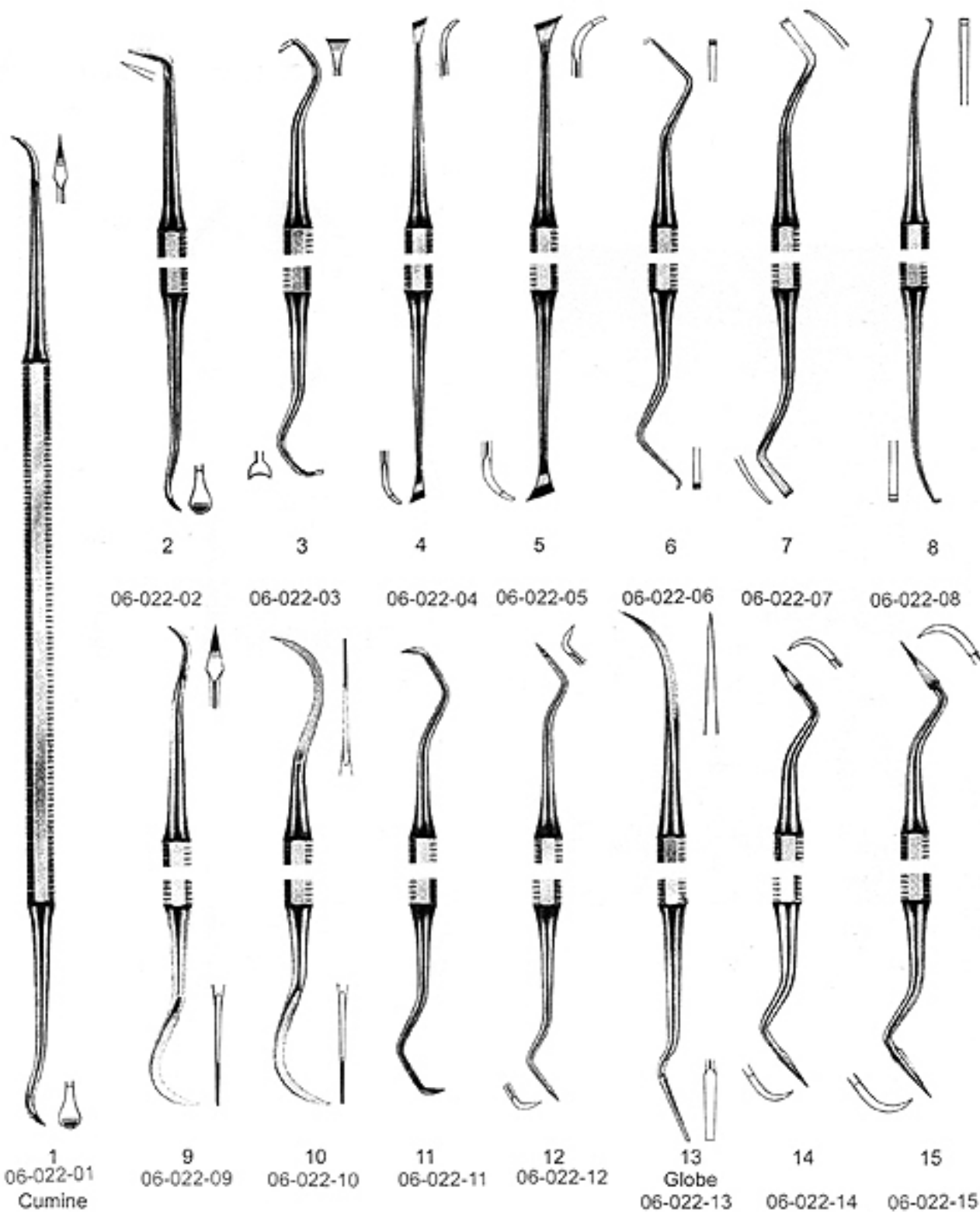

SCALERS
INSTRUMENTS A DETARTRER
LIMPIODORES DE SARRO

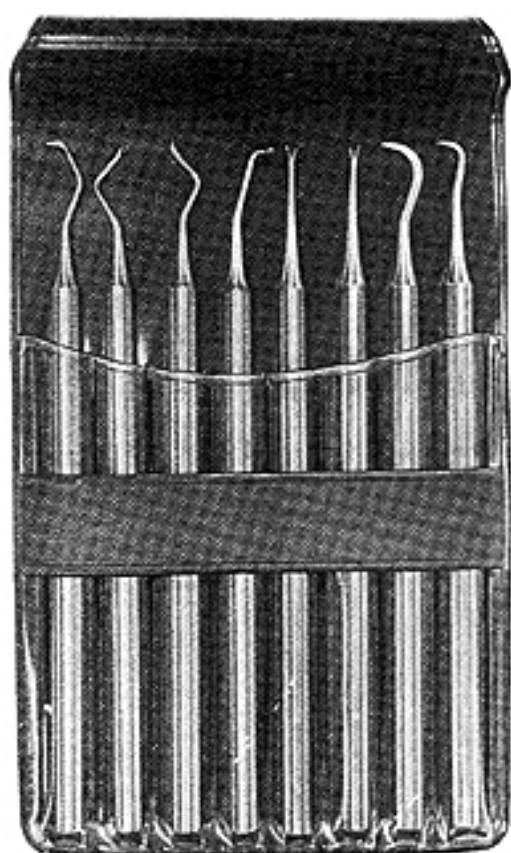
06-023-00

Set of Scalars, comprising
Figs. 06-024-01 to 06-024-08 in
black plastic wallet.

1
06-024-012
06-024-023
06-024-034
06-024-045
06-024-056
06-024-067
06-024-078
06-024-08

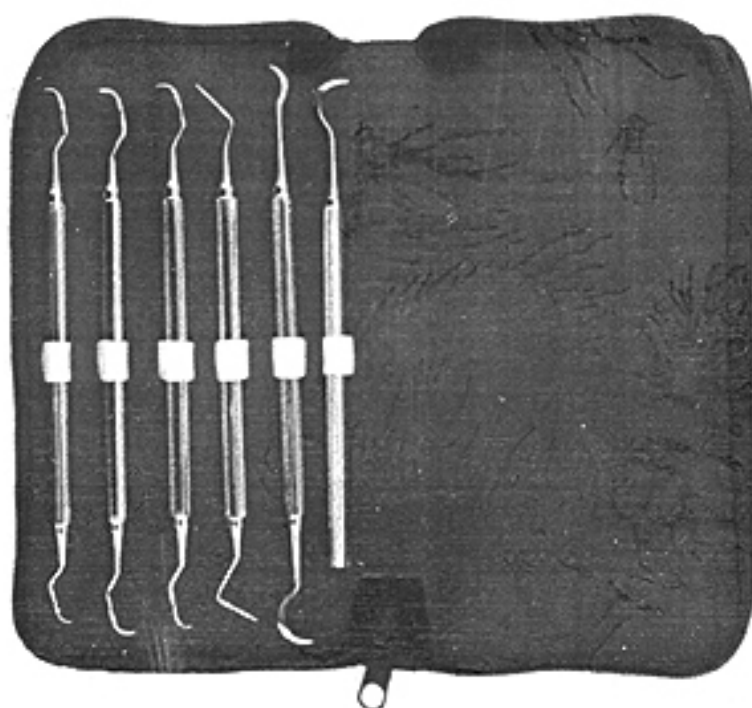

06-025-00
Scalling Set

- 1- Goldman fox pocket probe, double ended.
- 1- Jaquette scaler, single ended # 15
- 1- Jaquette scaler, double ended # U 15/33
- 1- Langer curette, double ended # L 1/2
- 1- Langer curette, double ended # L 3/4
- 1- Langer curette, double ended # L 5/6

PERIODONTAL CUURRETS
SICKLE-SCALERS
CURETAS



ARAIN



2-3
06-026-00



5-6
06-027-00



11
06-028-00



2-3
06-029-00



6
06-030-00



6
06-031-00



6
06-032-00



4
06-033-00



1
06-034-00



1
06-035-00



CURETTES
KURETTEN
CURETAS

06

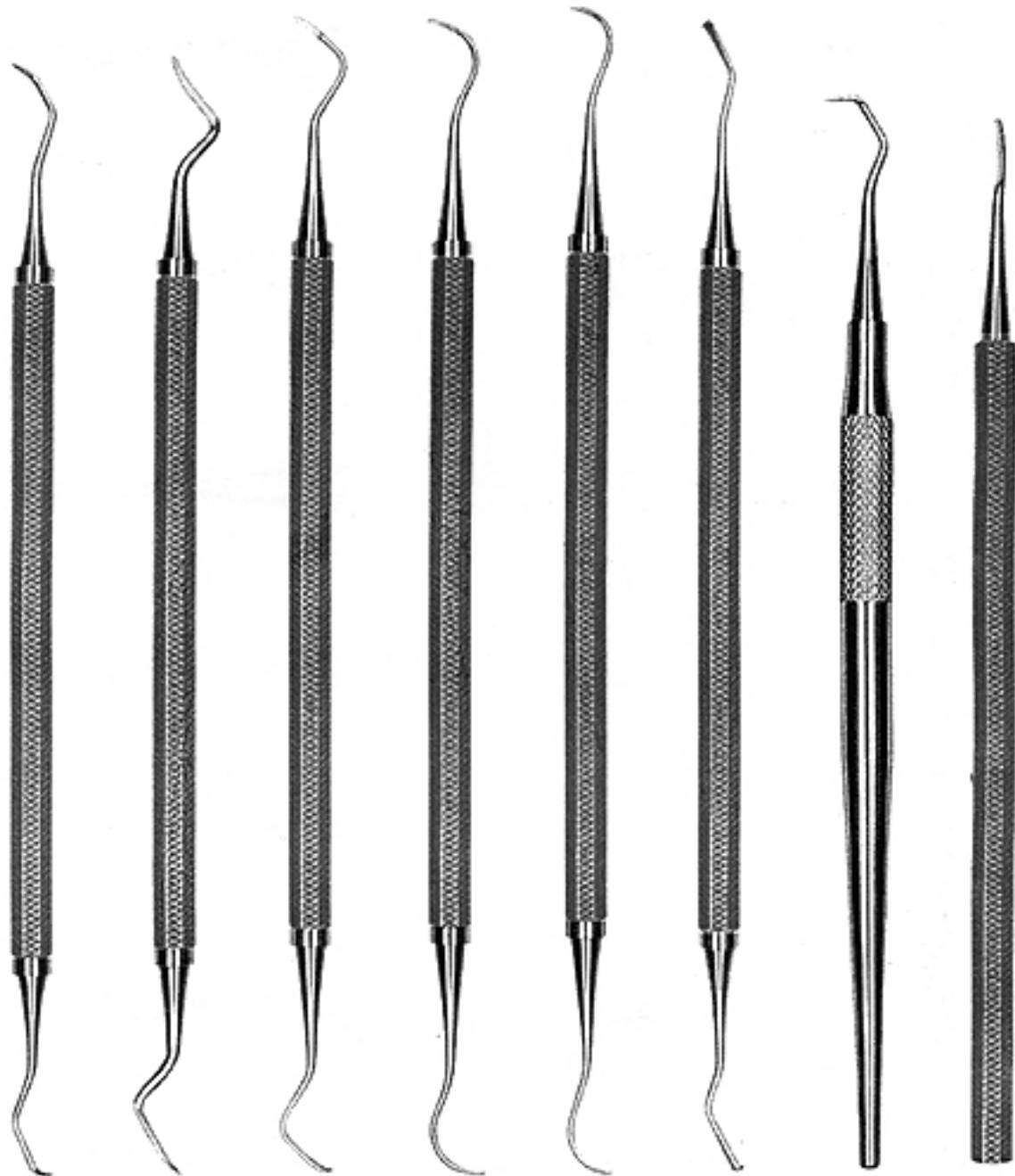

11/12
06-037-00

11A/12A
06-038-00

13S/14S
06-039-00

17S/18S
06-040-00

19/20
06-041-00

7/9
06-042-00
Hoe

10
06-043-00

1
06-044-00
Chisel

CURETTES
KURETTEN
CURETAS



ARAIN

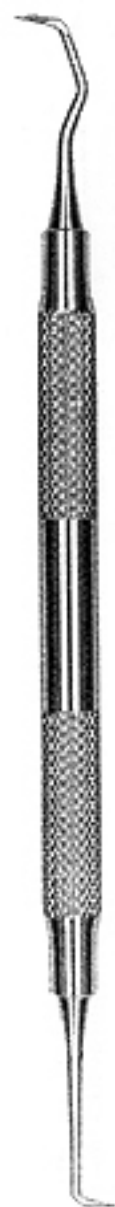

GF-1
06-045-00



GF-4
06-046-00



GF-3
06-047-00



GF-2
06-048-00



GF-6
06-049-00



GF-5
06-050-00



GF-21
06-051-00



GF-21S
06-052-00





ARAIN

CURETTES
KURETTEN
CURETAS

06



3/7
06-053-00

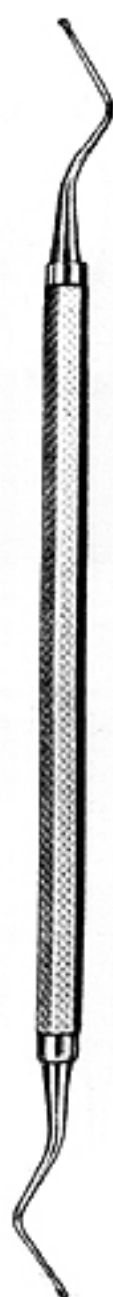

5/11
06-054-00



U15/33+
06-055-00



17S/18S+
06-056-00

M. A. ARAIN & BROTHERS (PVT.) LTD.

129

CURETTES
LOFFEL
CURETAS OSEASARAIN $\frac{1}{2}$
06-057-00 $\frac{3}{4}$
06-058-00 $\frac{5}{6}$
06-059-00 $\frac{7}{8}$
06-060-00 $\frac{9}{10}$
06-061-00 $\frac{11}{12}$
06-062-00



ARAIN

CURETTES
LOFFEL
CURETAS OSEAS

06

MAX GRIP



13/14
06-063-00



15/16
06-064-00



101/102
06-065-00



103/106
06-066-00



104/105
06-067-00

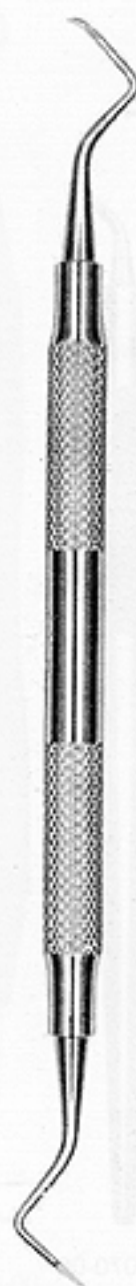

107/108
06-068-00



107/108S
06-069-00
Modified

M.A. ARAIN & BROTHERS (PVT.) LTD.

131

CURETTES
LOFFEL
CURETAS OSEAS



ARAIN

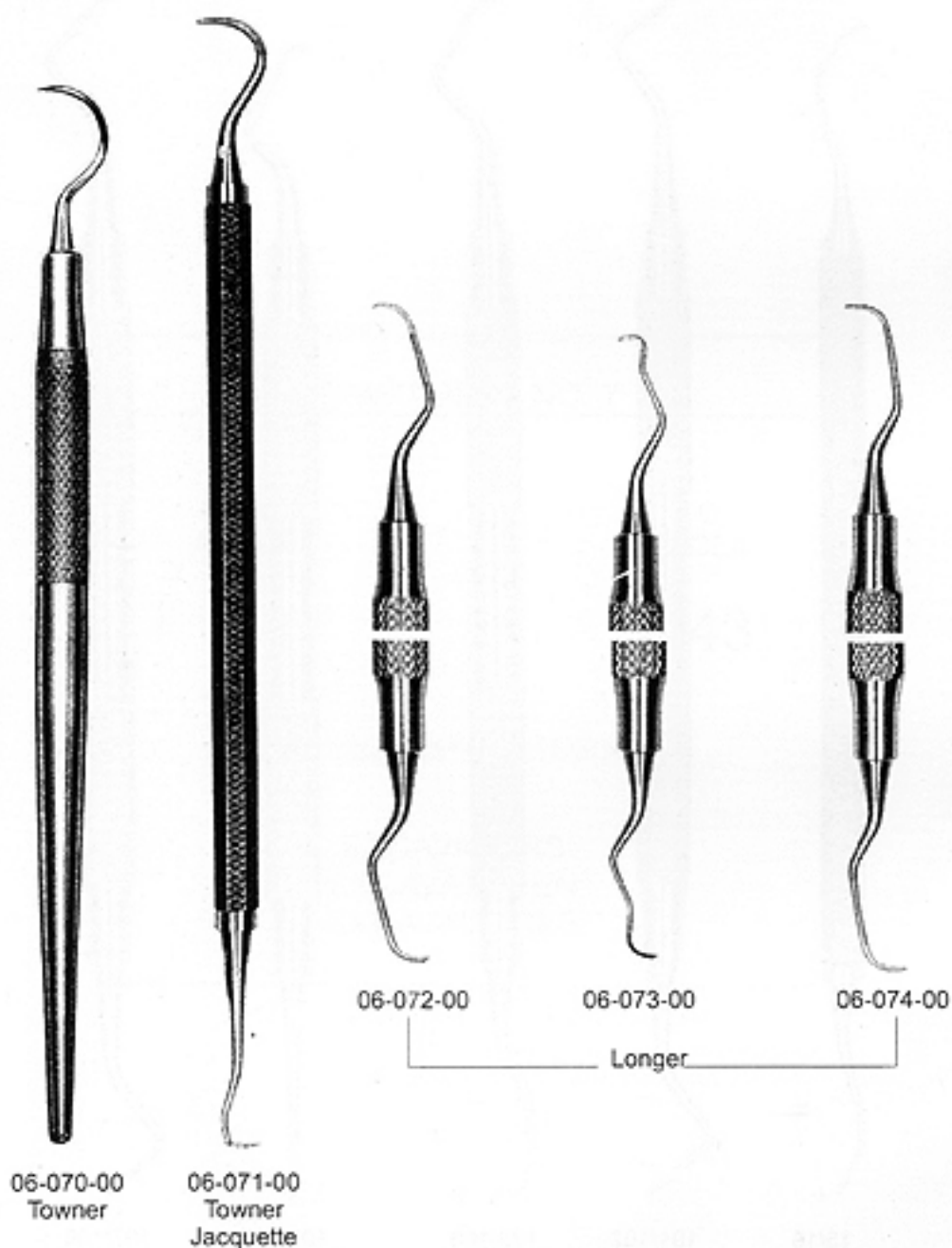



MAX GRIP

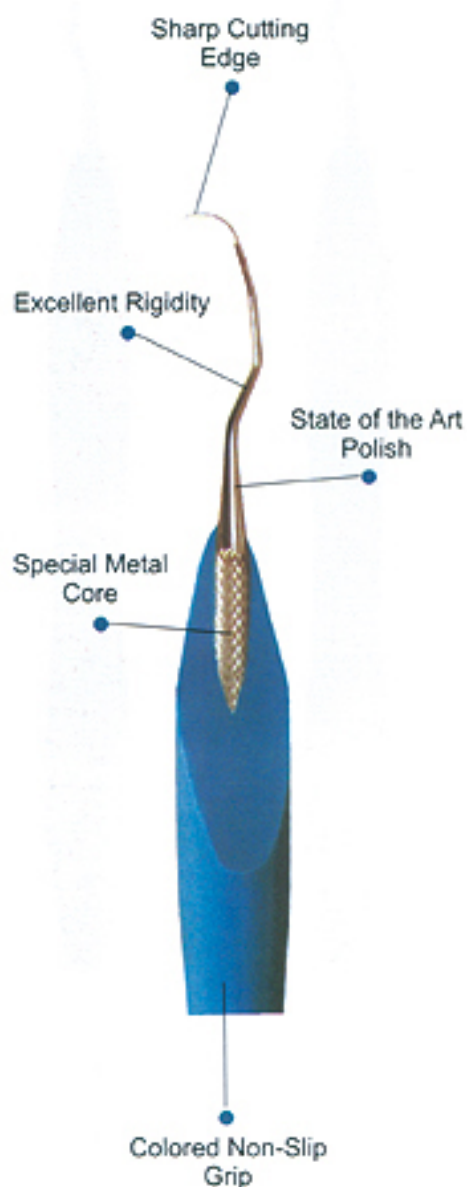

Overall light weight structure

*MAX GRIP Instruments can be sterilized / autoclaved upto 200°C
All other type of periodontal curettes & hand instruments including explorers, filling instruments etc. are available in MAX GRIP handles.*



1/2
06-075-00



3/4
06-076-00



5/6
06-077-00

**MAX GRIP**7/8
06-078-009/10
06-079-0011/12
06-080-0013/14
06-081-0015/16
06-082-00



CURETTES
LOFFEL
CURETAS OCEAS

06



Gracey
1/2
06-108-00



Gracey
3/4
06-109-00



Gracey
5/6
06-110-00



Gracey
7/8
06-111-00



Gracey
9/10
06-112-00



Gracey
11/12
06-113-00



Gracey
13/14
06-114-00

NOTE: All other hand instruments are also available in this Hollow Handle

Department

07

EXCAVATORS
EXCAVATOREN
EXCAVADORES

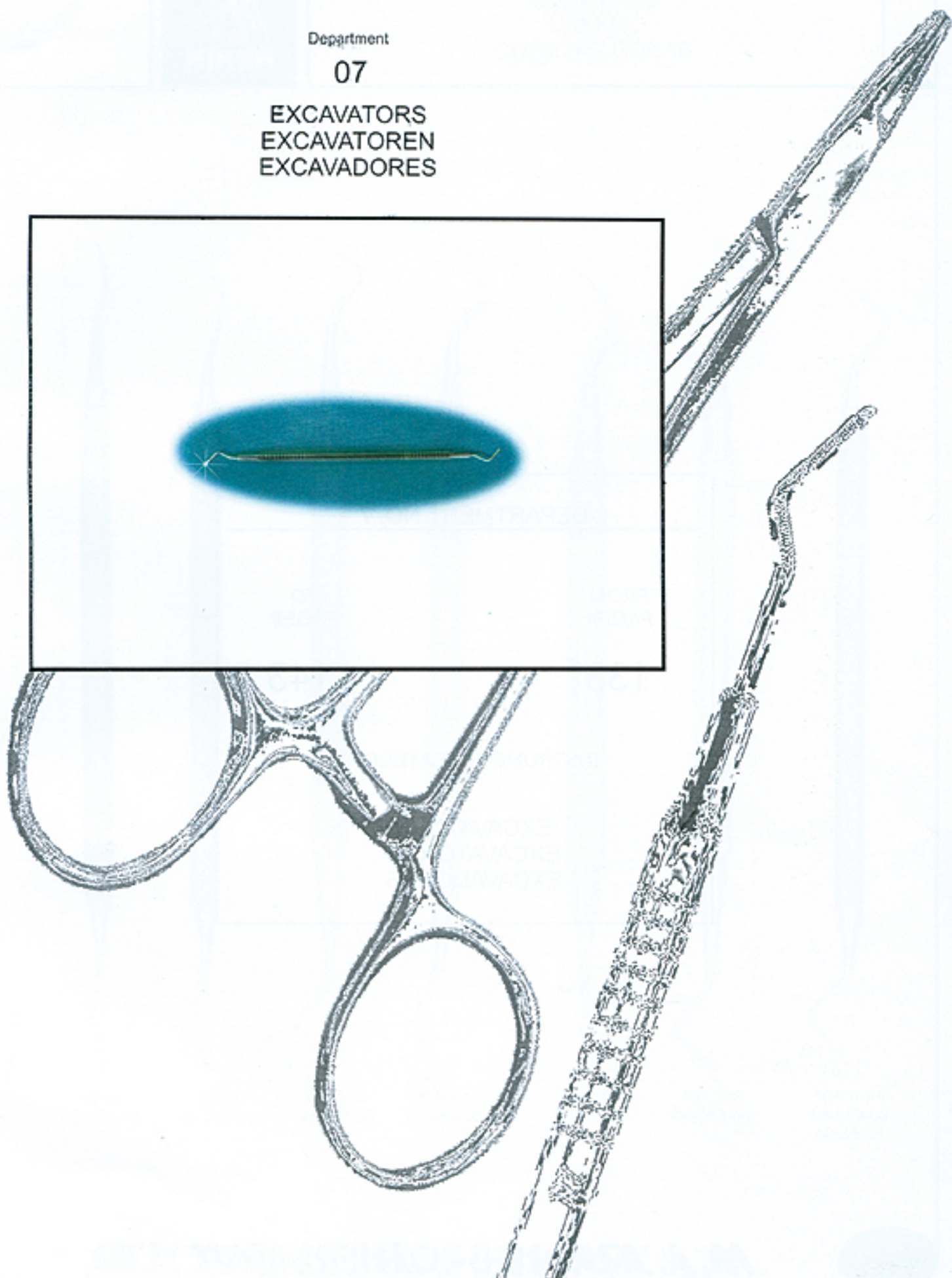
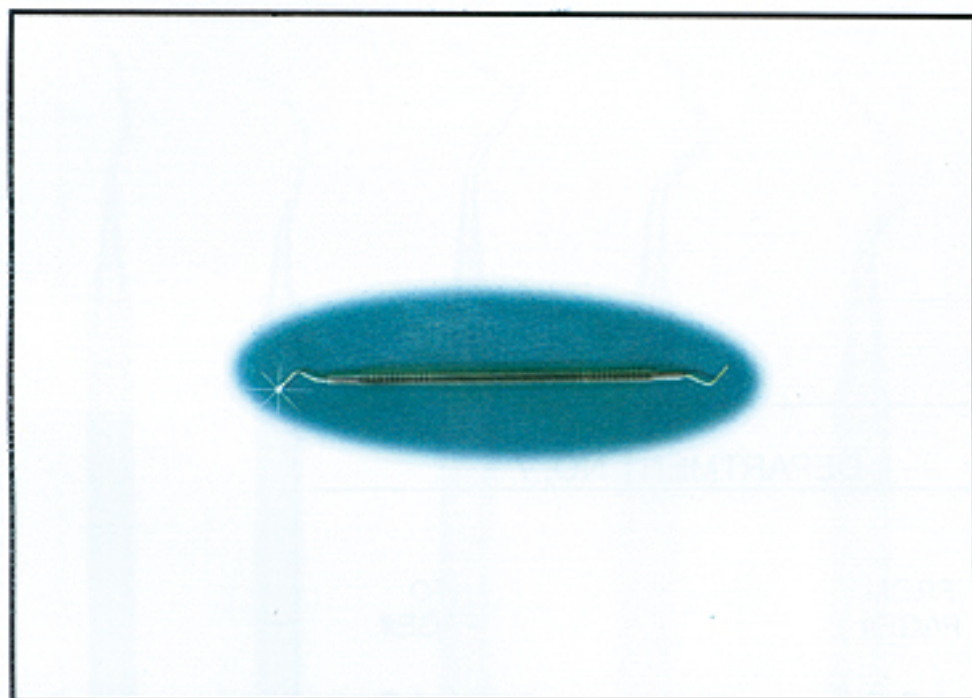

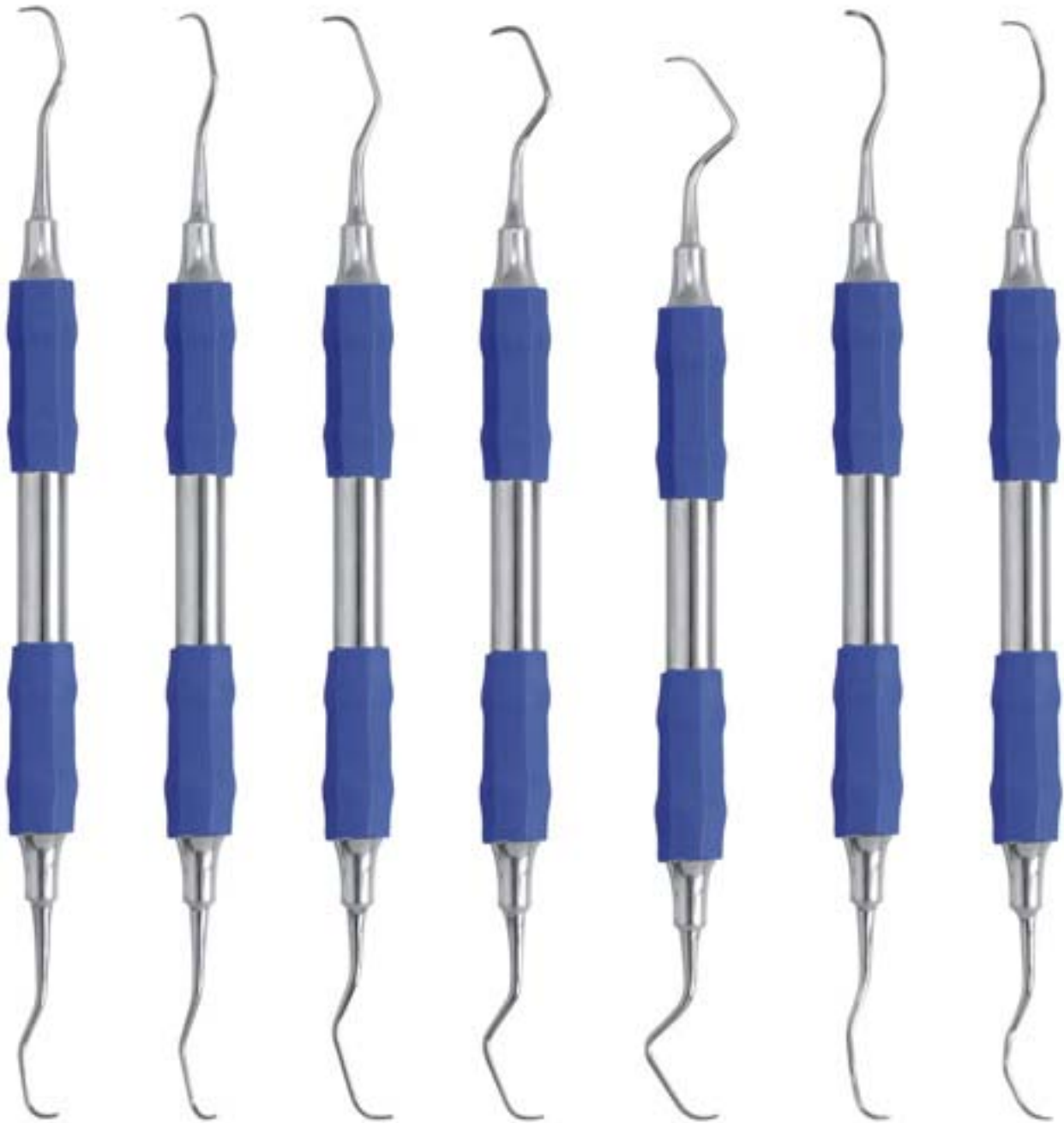
CURETTES
LOFFEL
CURETAS OCEASGracey
1/2
06-120-00Gracey
3/4
06-121-00Gracey
5/6
06-122-00Gracey
7/8
06-123-00Gracey
9/10
06-124-00Gracey
11/12
06-125-00Gracey
13/14
06-126-00

NOTE: All other hand instruments are also available in SOFTHOLD Handle

DEPARTMENT NO. 7

FROM
PAGE#

133

TO
PAGE#

143

INSTRUMENTS CATEGORY

EXCAVATORS
EXCAVATOREN
EXCAVADORES

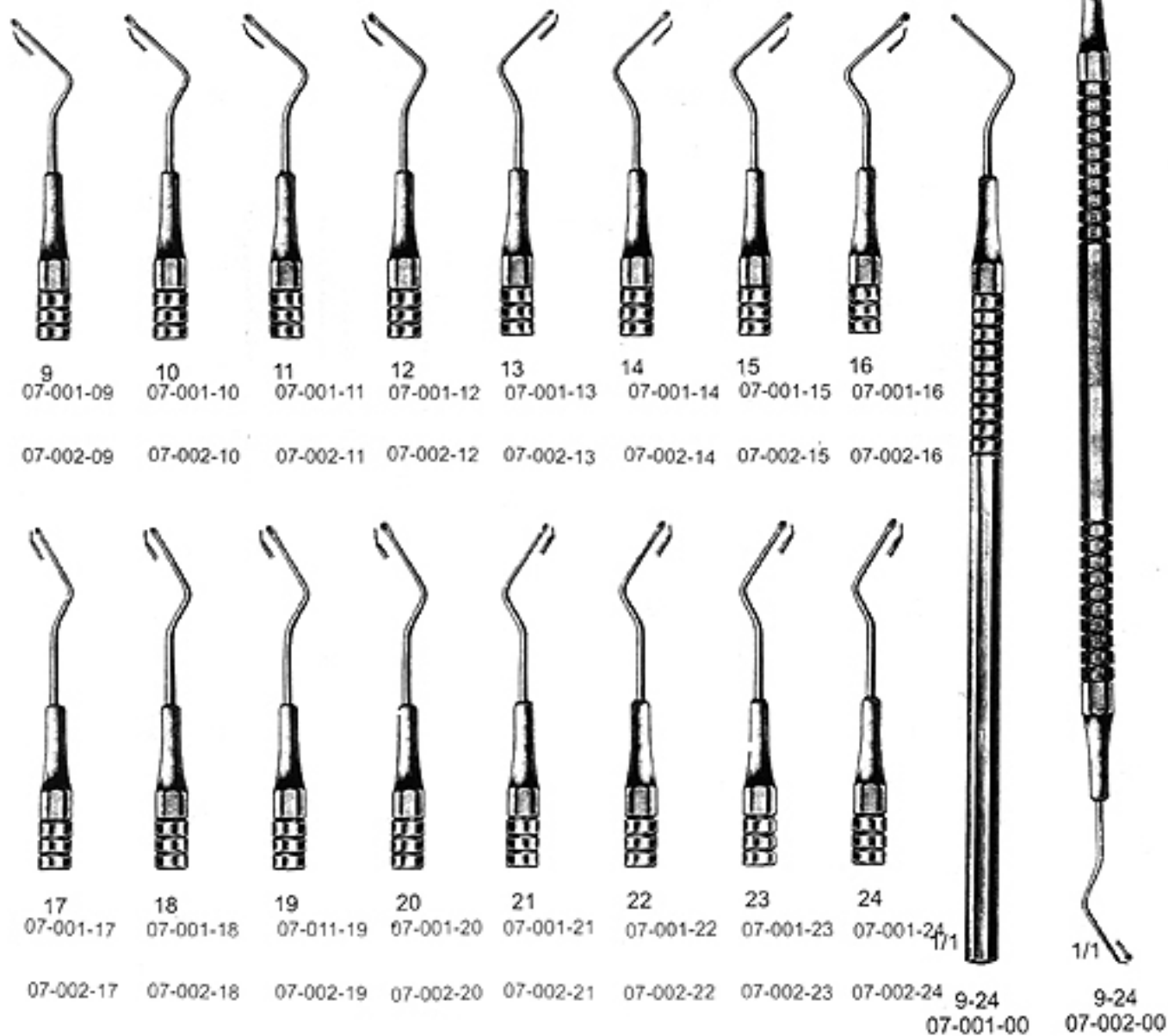

51-52
07-003-0057-58
07-004-0063-64
07-005-0075-76
07-006-0081-82
07-007-0017-21
07-008-0018-22
07-009-0018-23
07-010-00



EXCAVATORS
EXCAVATOREN
EXCAVADORES

07

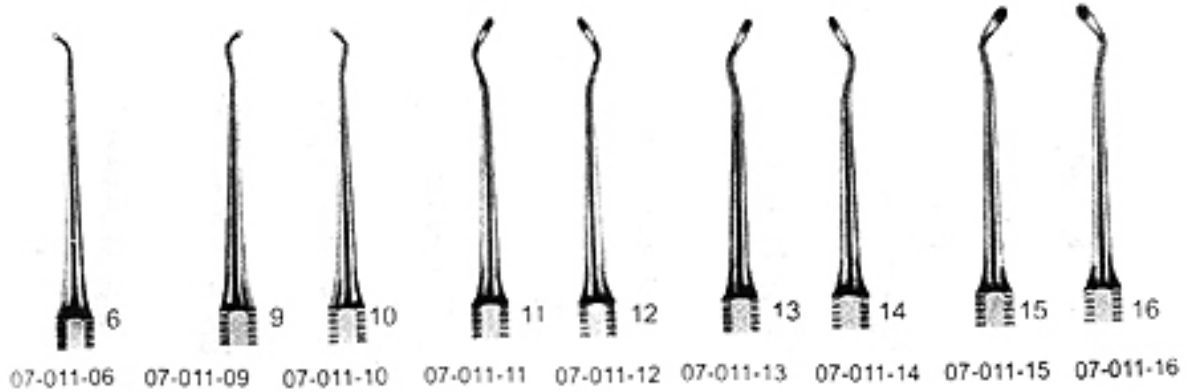

Darby-perry

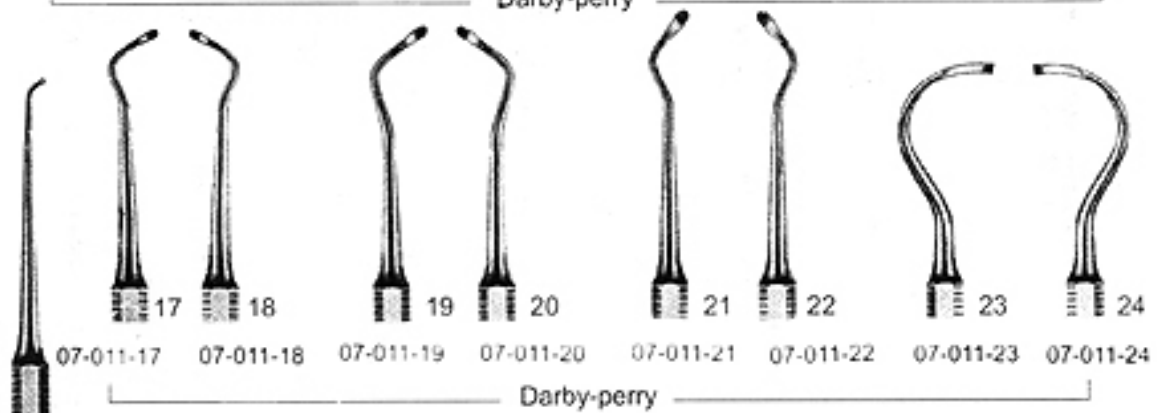

Darby-perry

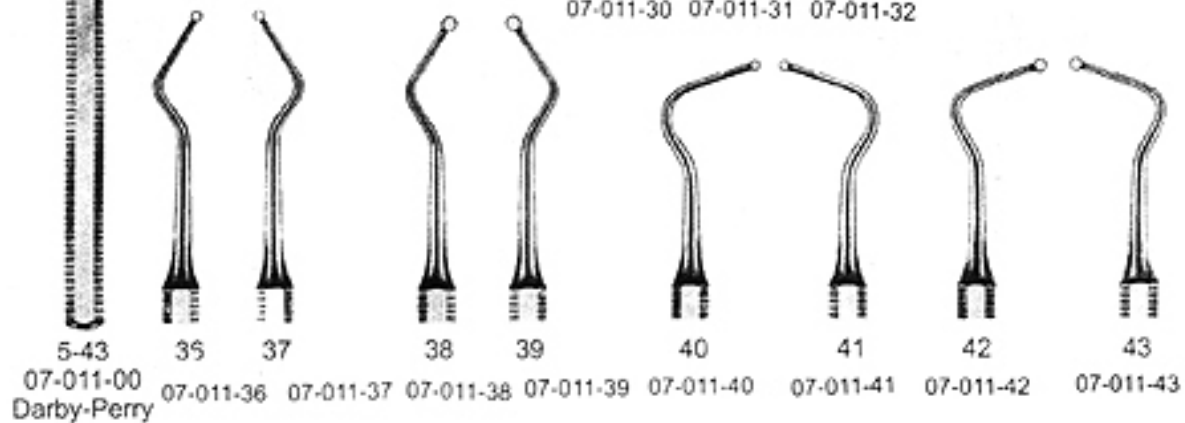
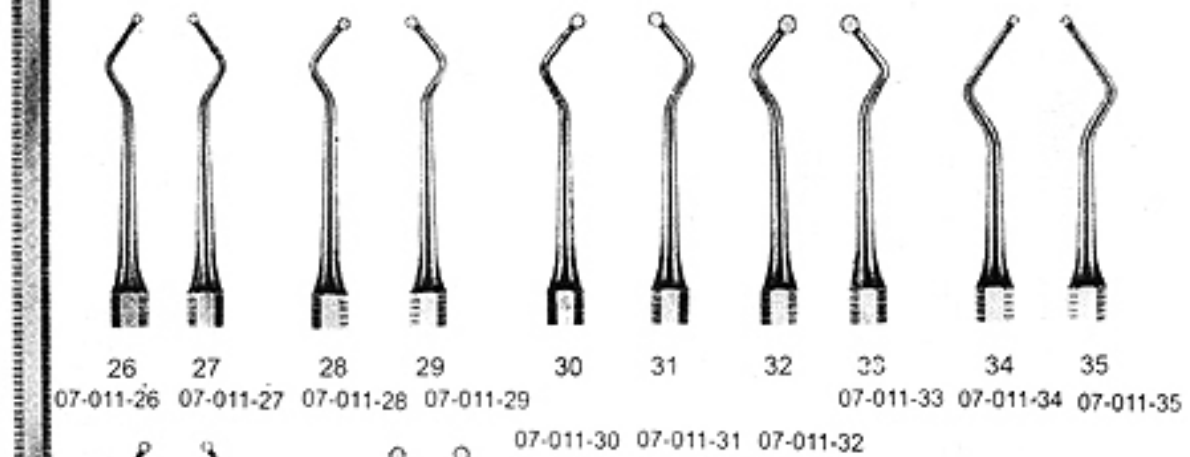

07-011-00
Darby-Perry

M. A. ARAIN & BROTHERS (PVT.) LTD.

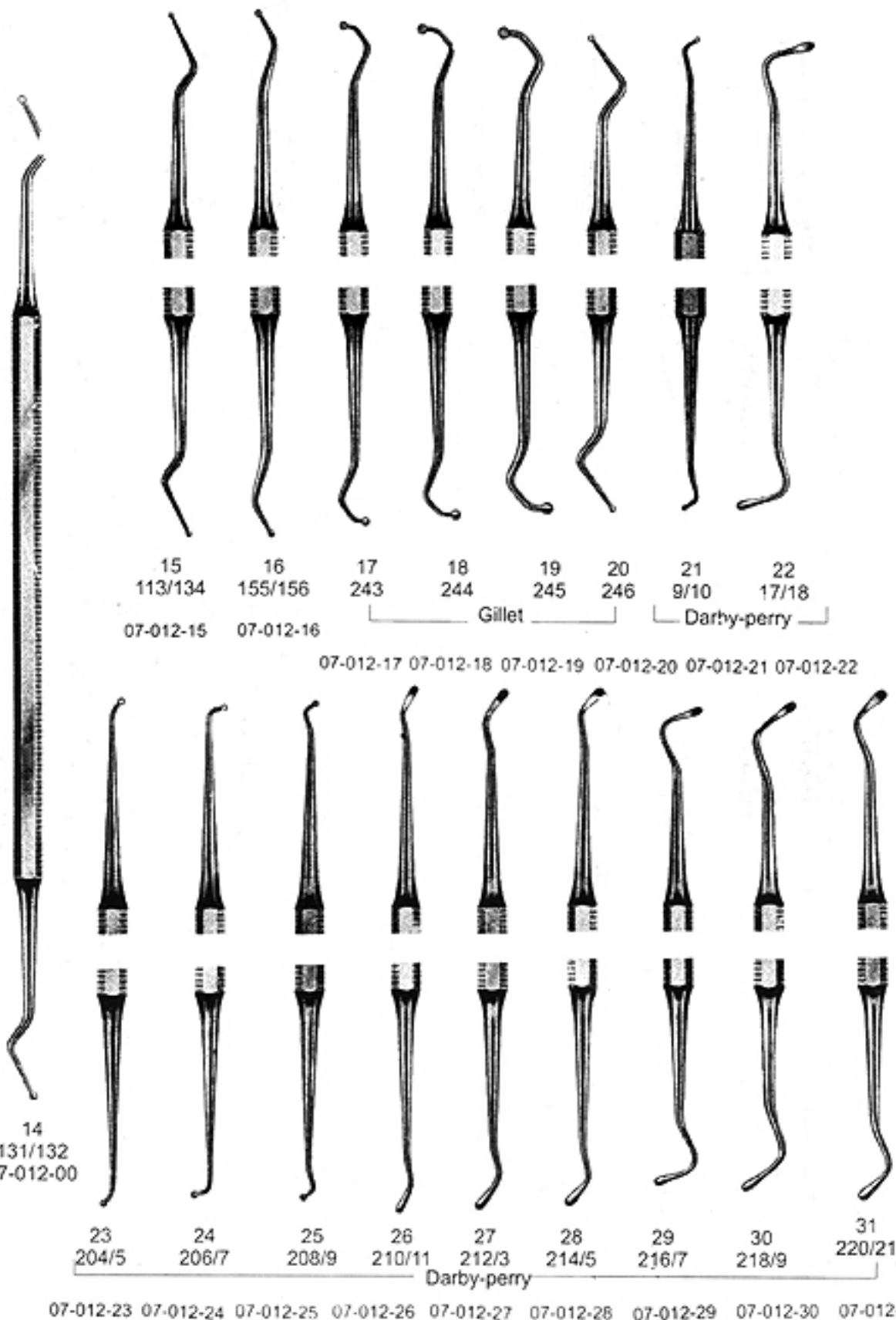



EXCAVATORS
EXCAVATOREN
EXCAVADORES

07

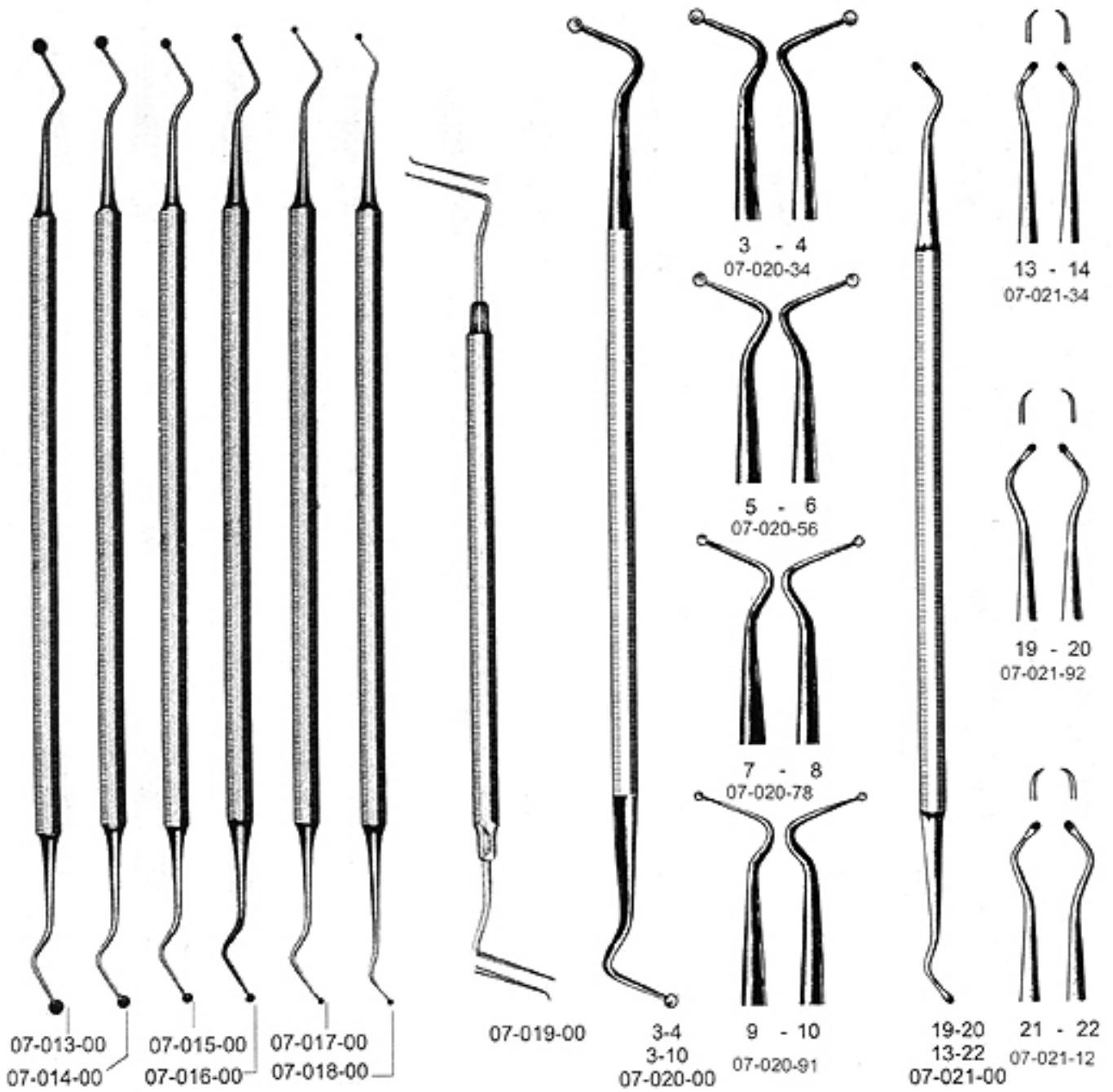

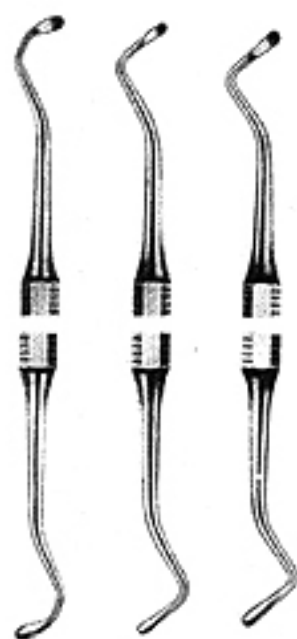

14 17 18
White

07-022-14 07-022-17 07-022-18

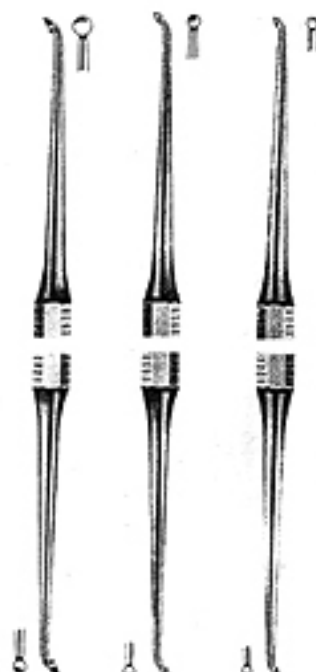

2 3 4
73/74 74/111 111/112

07-023-02 07-023-03 07-023-04

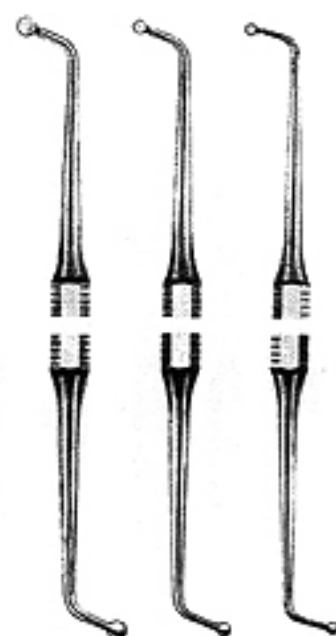

5 6 7
113/114 115/116 117/118

07-023-05 07-023-06 07-023-07

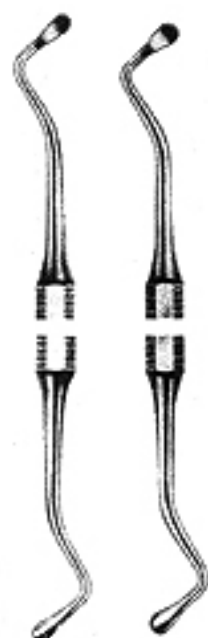

19 20
White

07-022-19 07-022-20

1
72/73
07-023-00

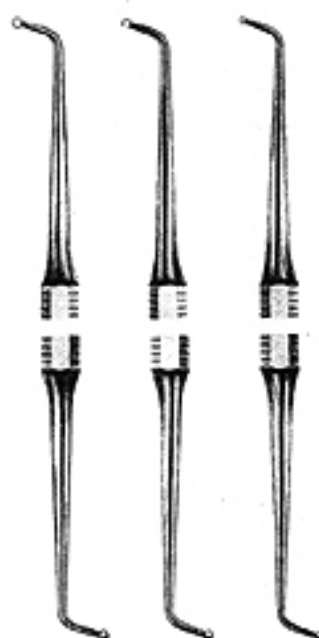

8 9 10
119/120 121/122 123/124

07-023-08 07-023-09 07-023-10

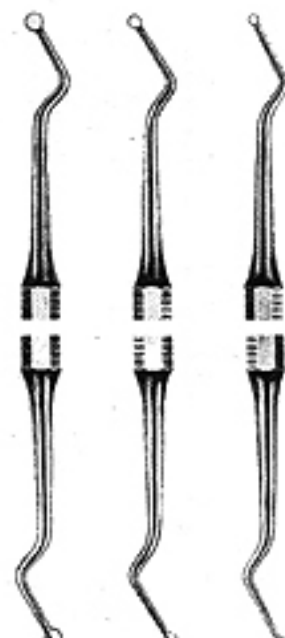

11 12 13
125/126 127/128 129/130

07-023-11 07-023-12 07-023-13

5-20
07-022-00
White

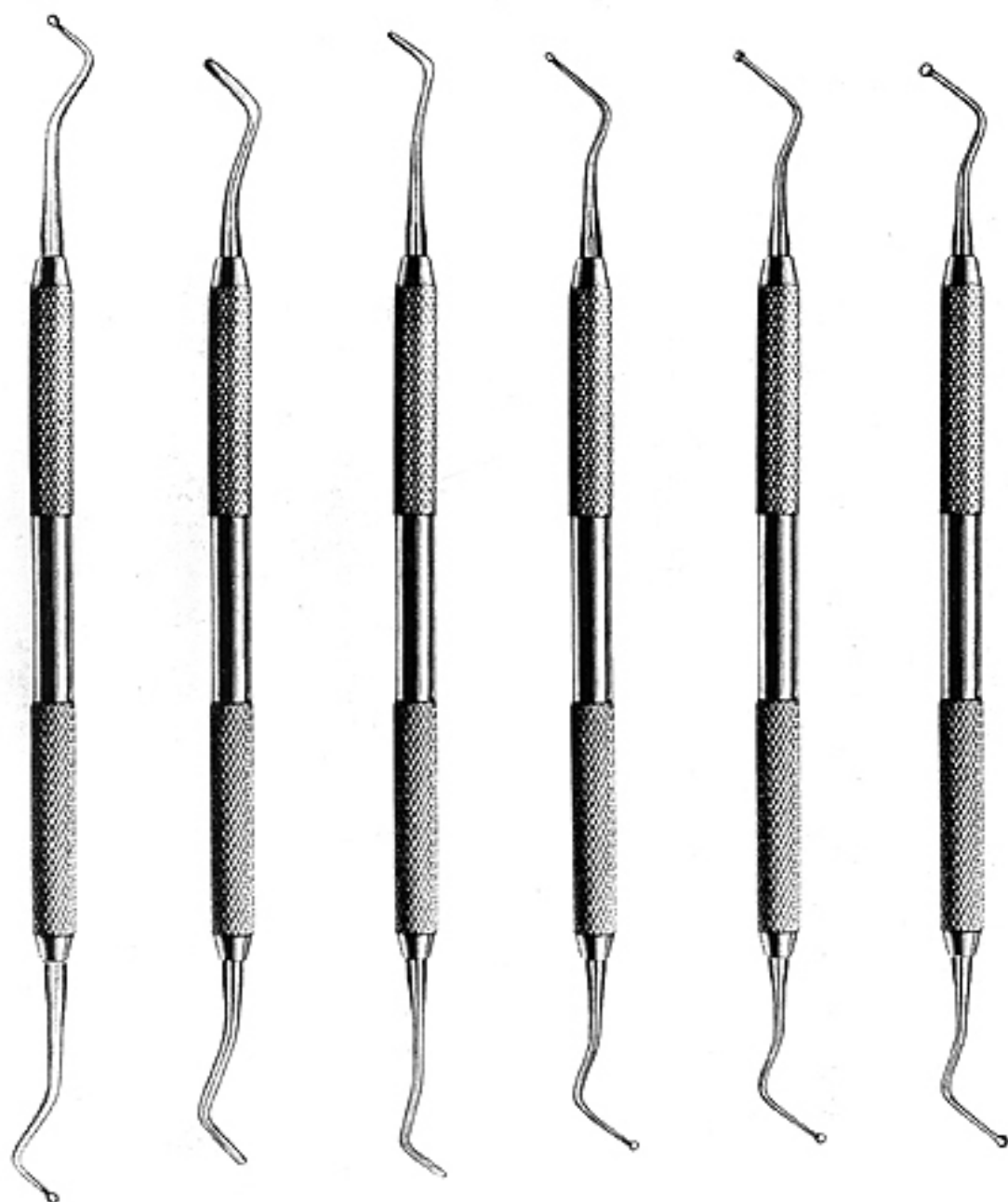

39
Fig.38/39
07-024-00

64
Fig.63/64
07-025-00

66
Fig.65/66
07-026-00

31L
07-027-00

32L
07-028-00

33L
07-029-00

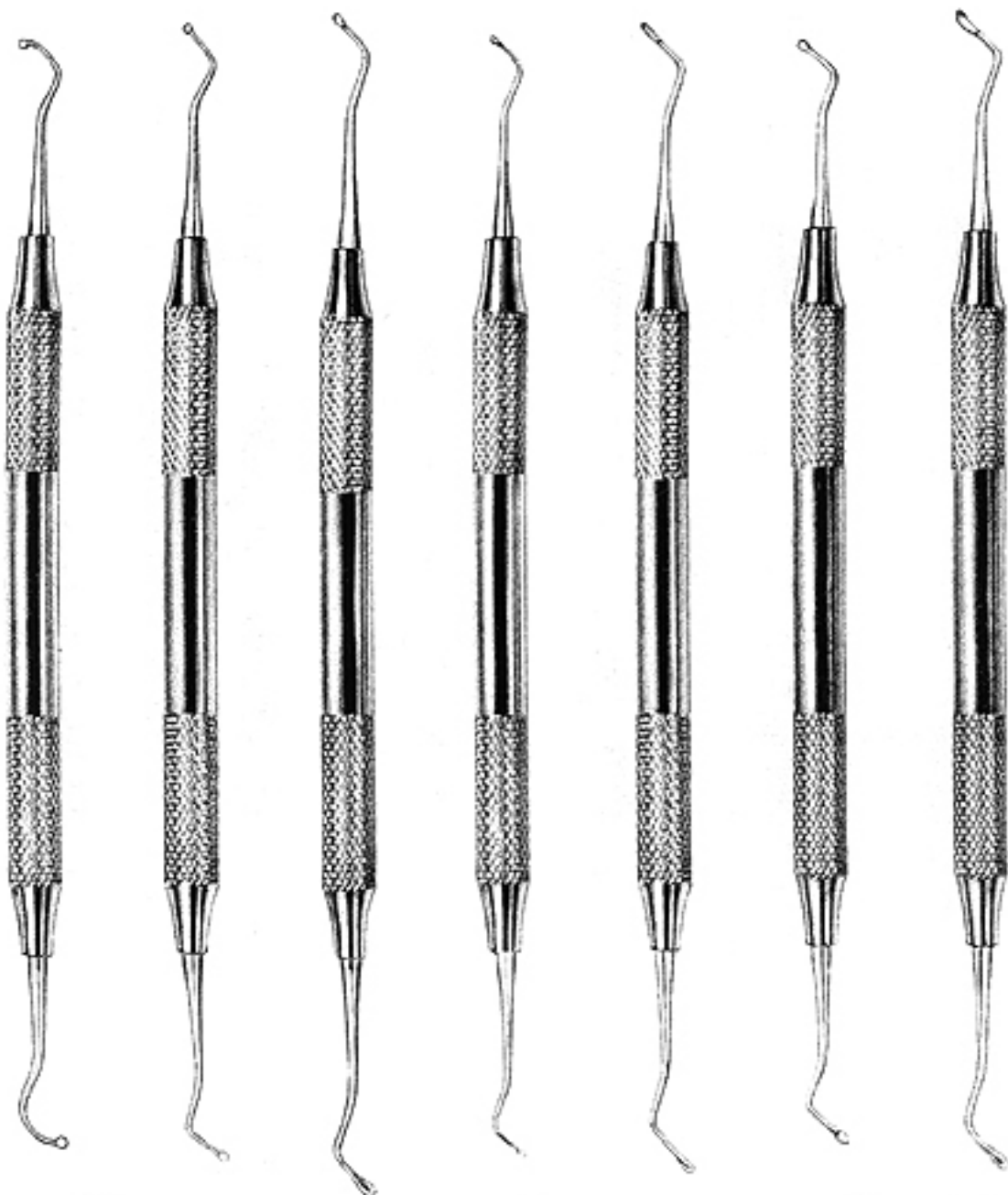

14
07-030-00

17
07-031-00

17W
07-032-00
Oval Spoon

18
07-033-00

18W
07-034-00
Oval Spoon

19
07-035-00

19W
07-036-00
Oval Spoon



EXCAVATORS
EXCAVATOREN
EXCAVADORES

07

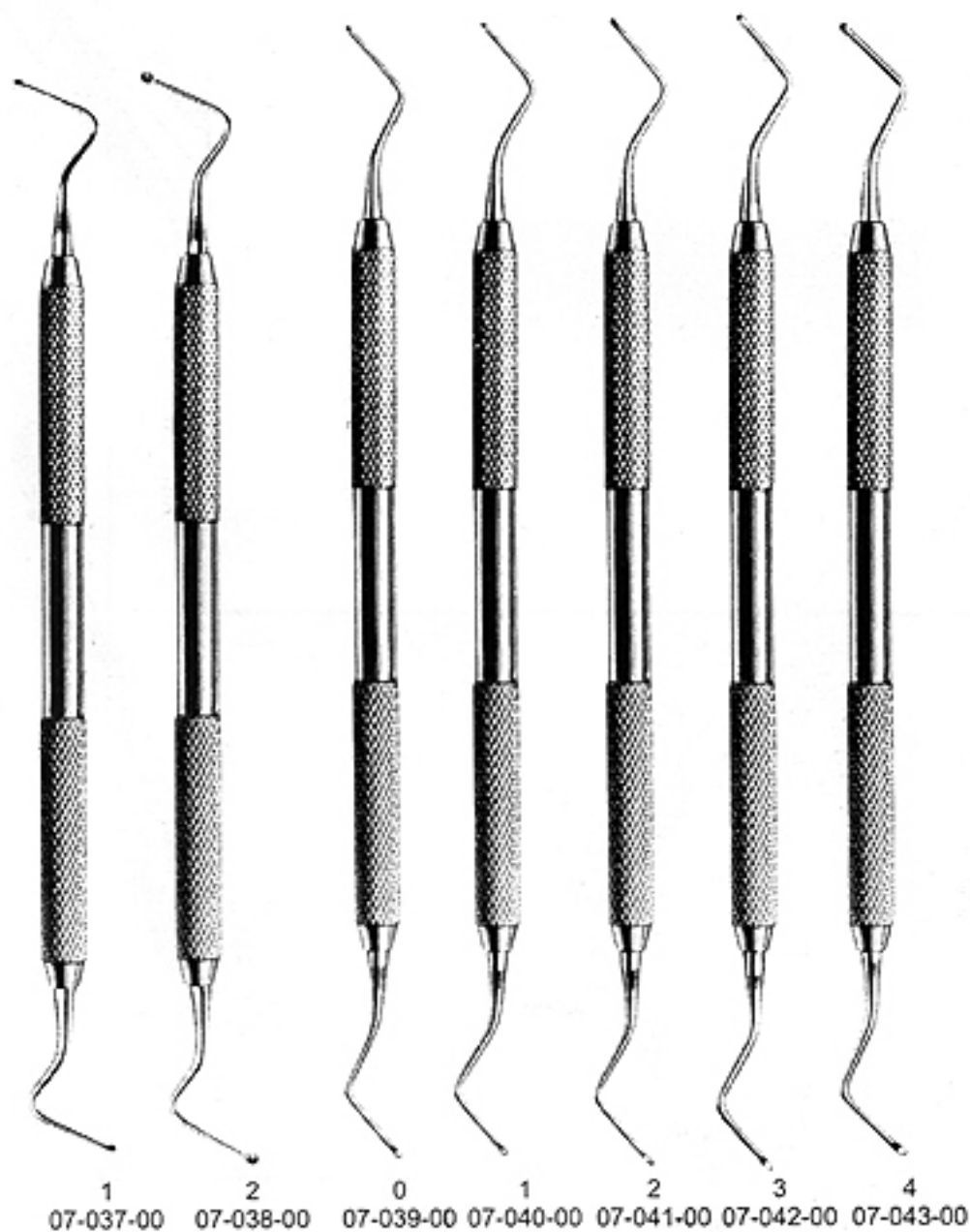

Department

08

PROBES AND EXPLORERS
SONDES ET EXPLORATEURS
SONDAS Y EXPLORADORES

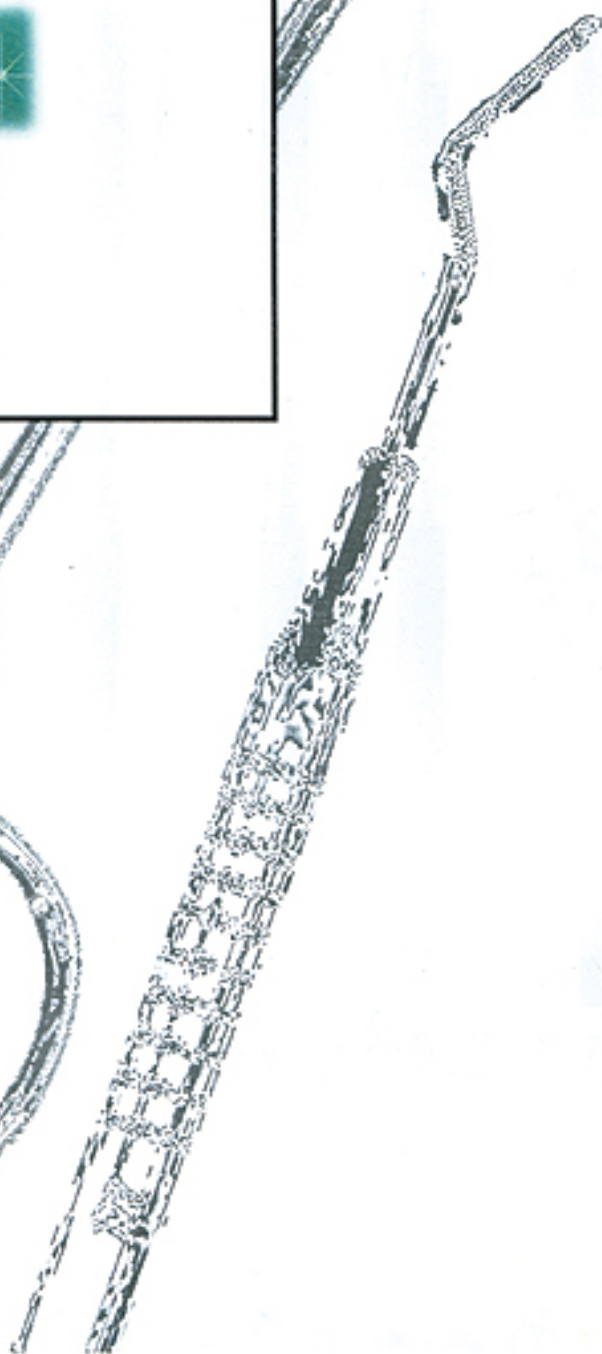
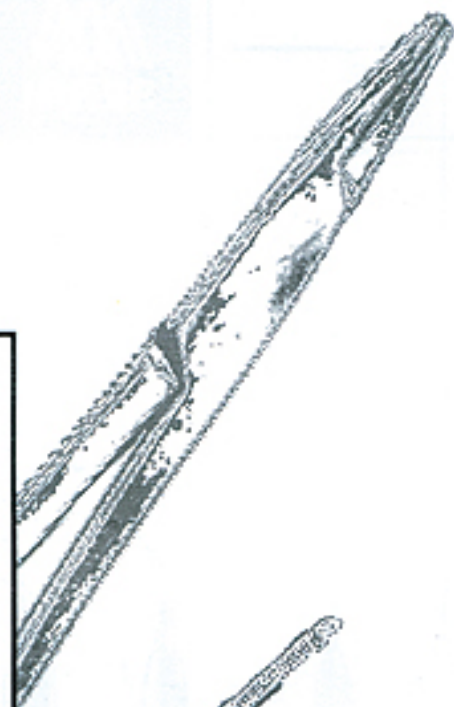
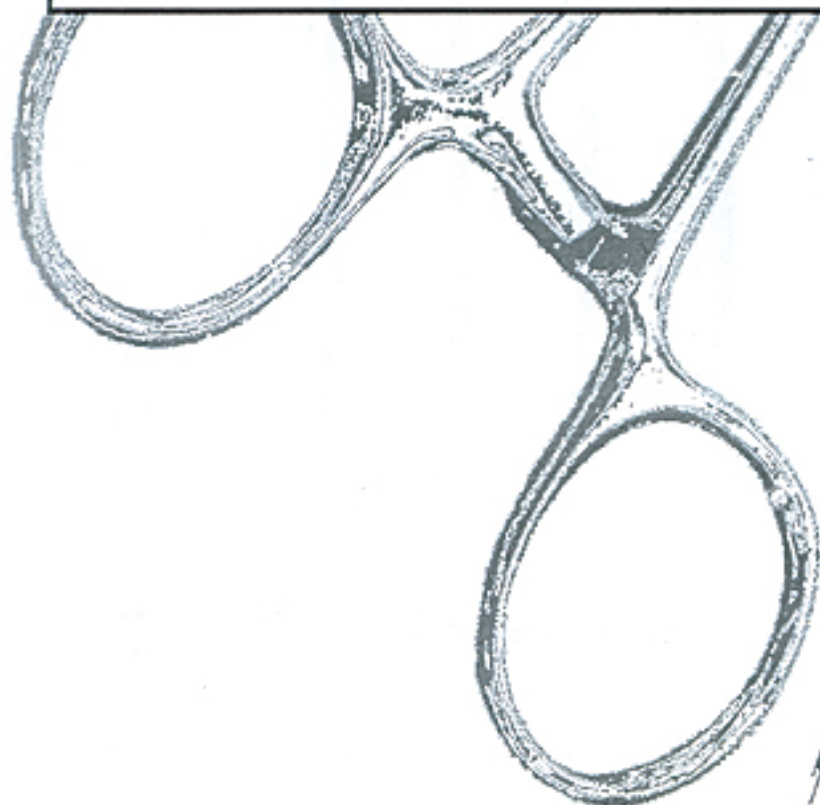
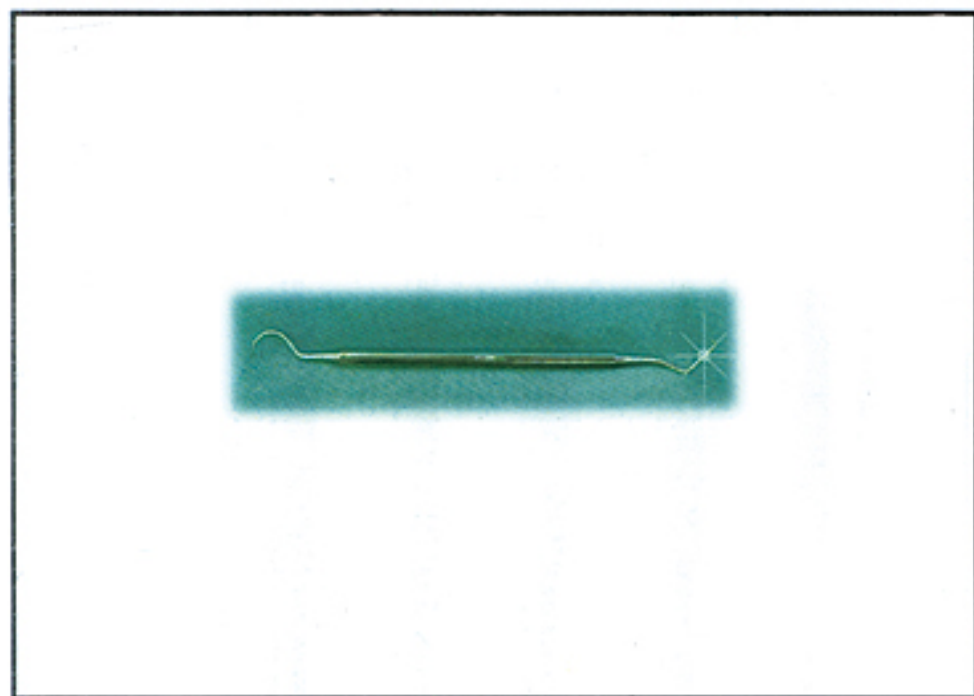

DEPARTMENT NO. 8

FROM
PAGE#

144

TO
PAGE#

150

INSTRUMENTS CATEGORY

PROBES AND EXPLORERS
SONDES ET EXPLORATEURS
SONDAS Y EXPLORADORES

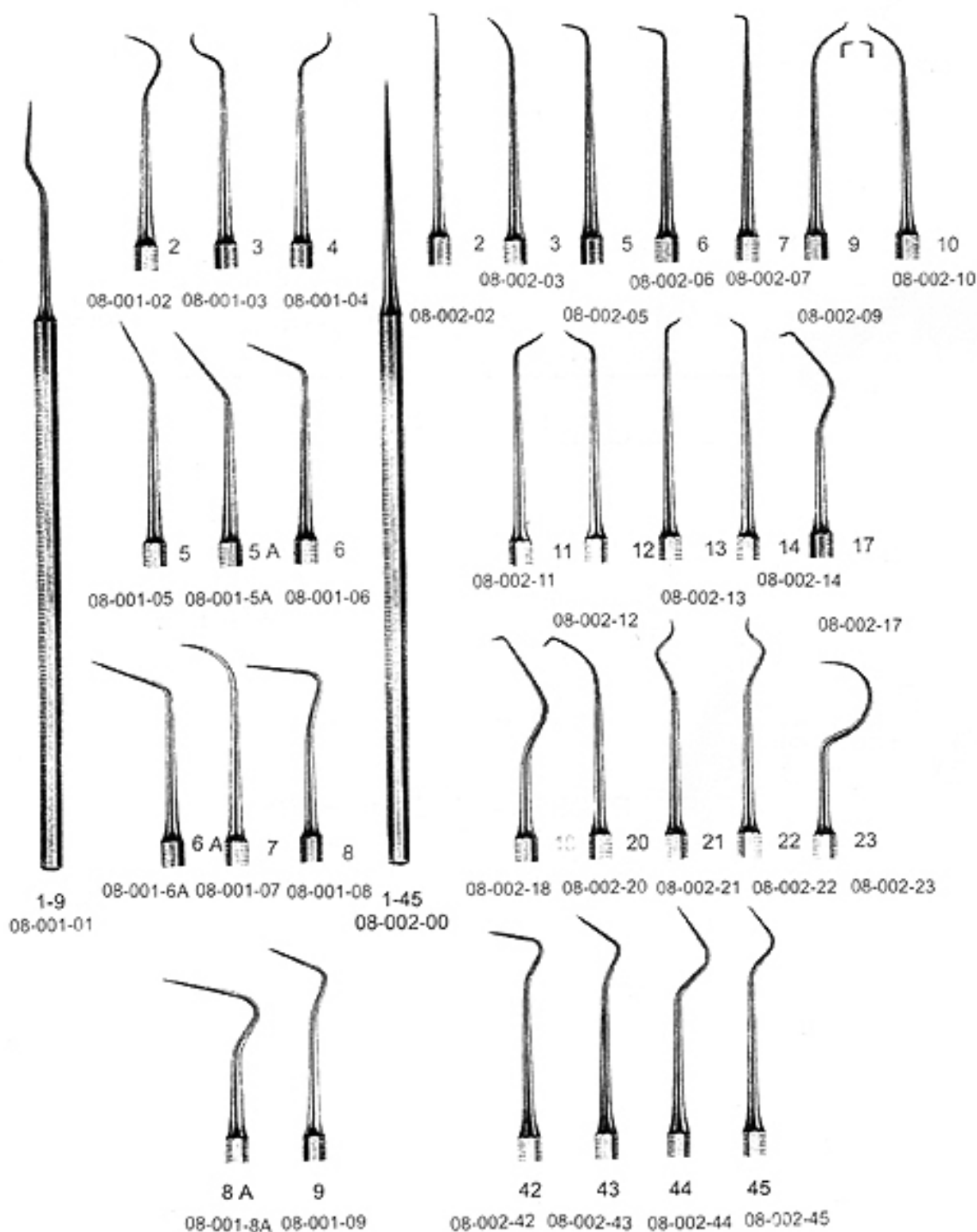

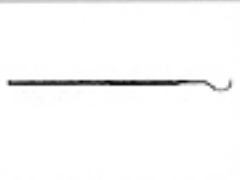

PROBES AND EXPLORERS
 SONDES ET EXPLORATEURS
 SONDAS Y EXPLORADORES

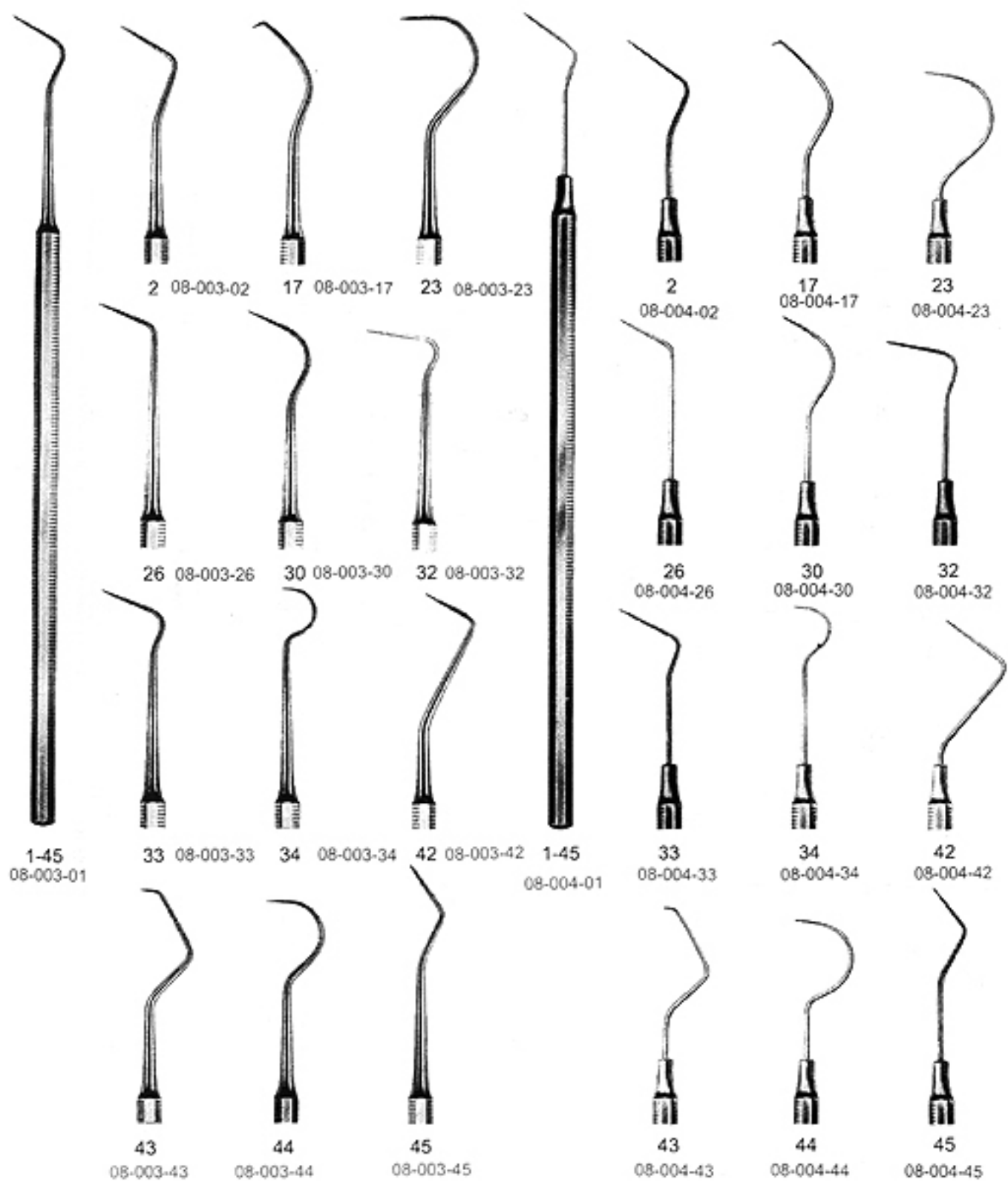

EXPLORERS
ZAHNSONDEN
SONDAS



ARAIN

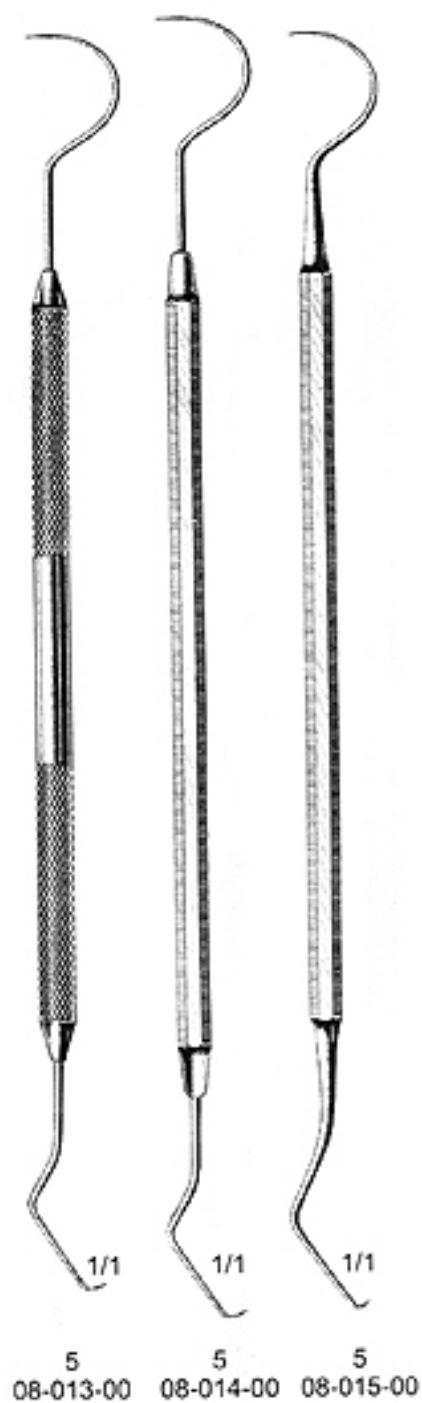
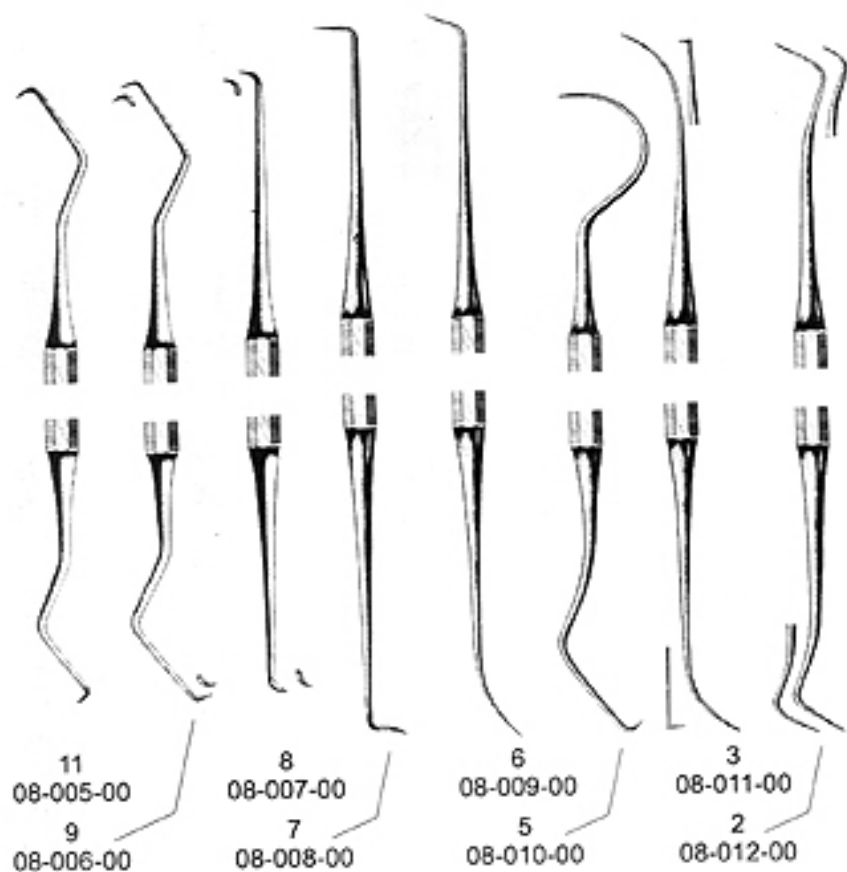

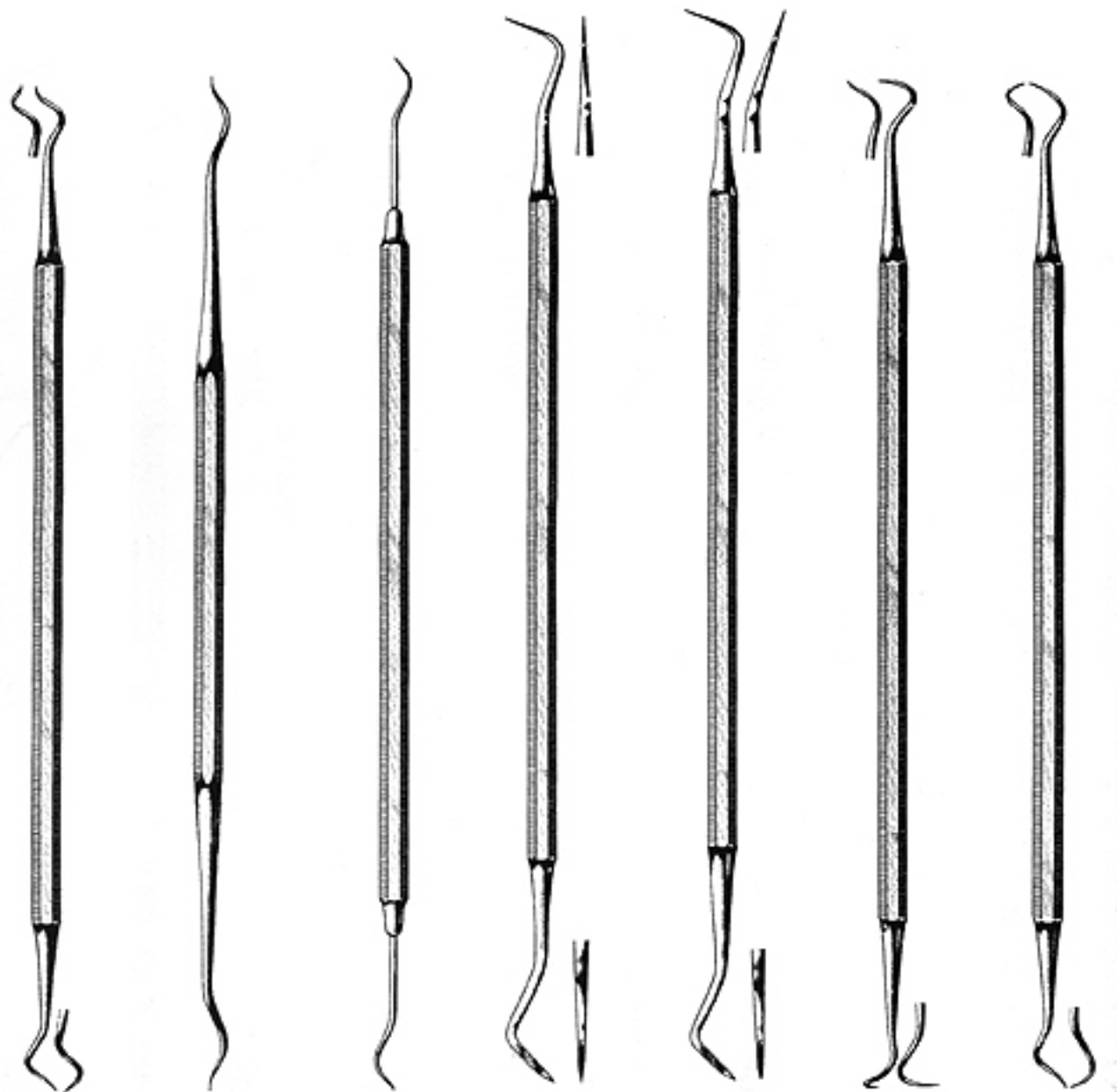

08-016-03

08-017-00

08-018-00

08-019-00

08-020-00

08-021-00

08-022-00

Weston

Lange

EXPLORERS
ZAHNSONDEN
SONDAS

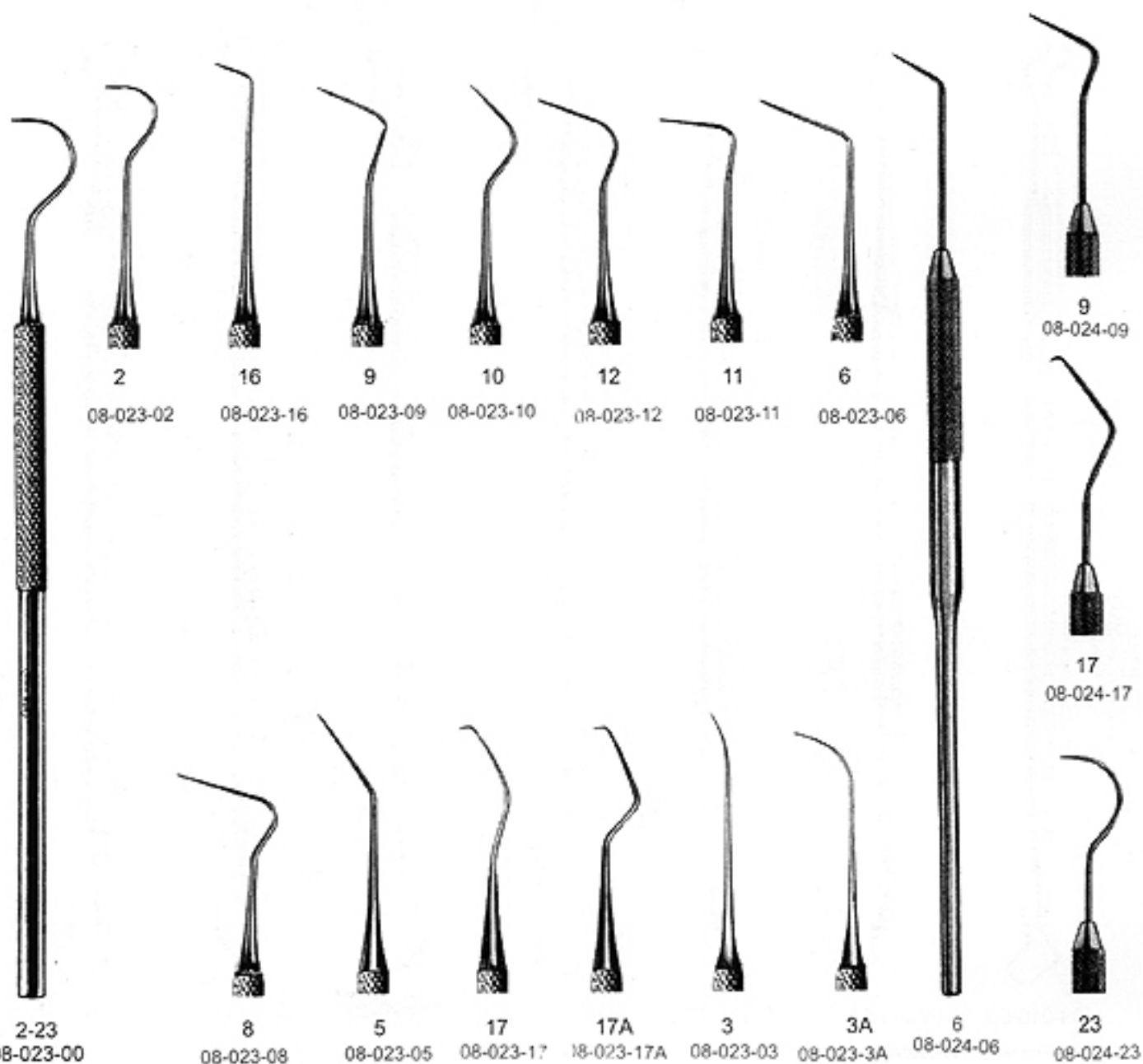
Department

09

ENDODONTIC AND NERVE INSTRUMENTS
INSTRUMENTS A NERFS
NERVINSTRUMENTE

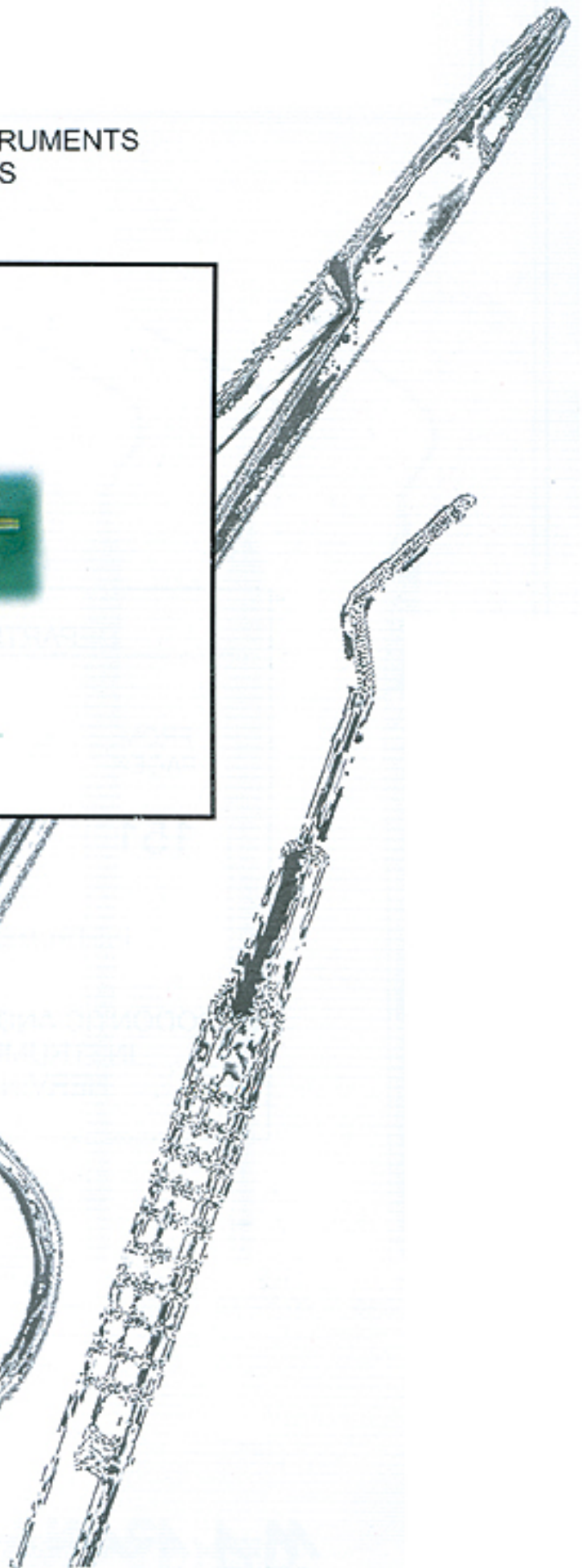
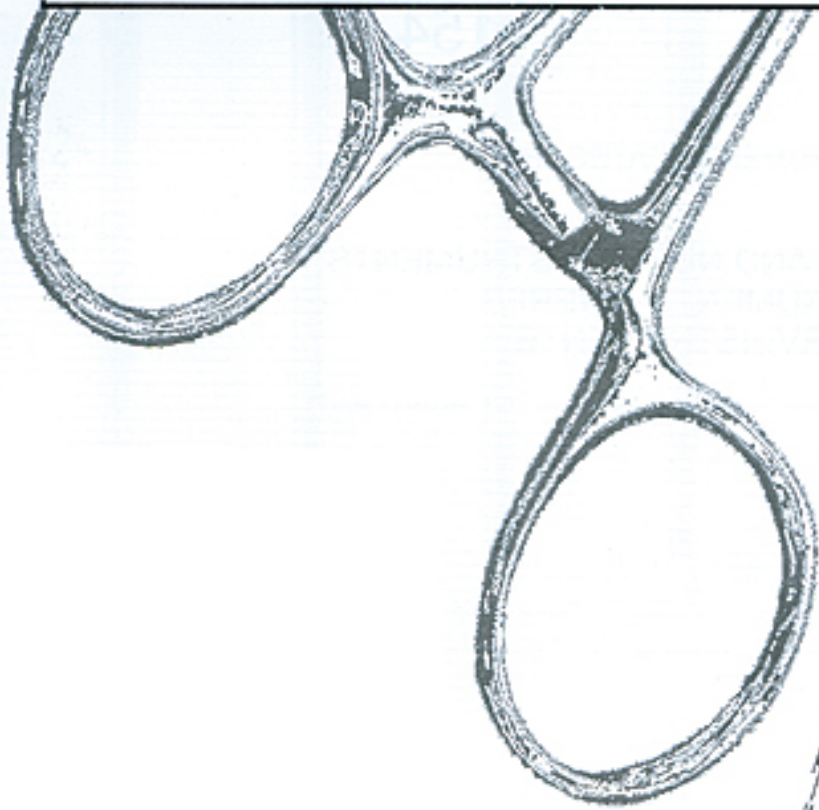
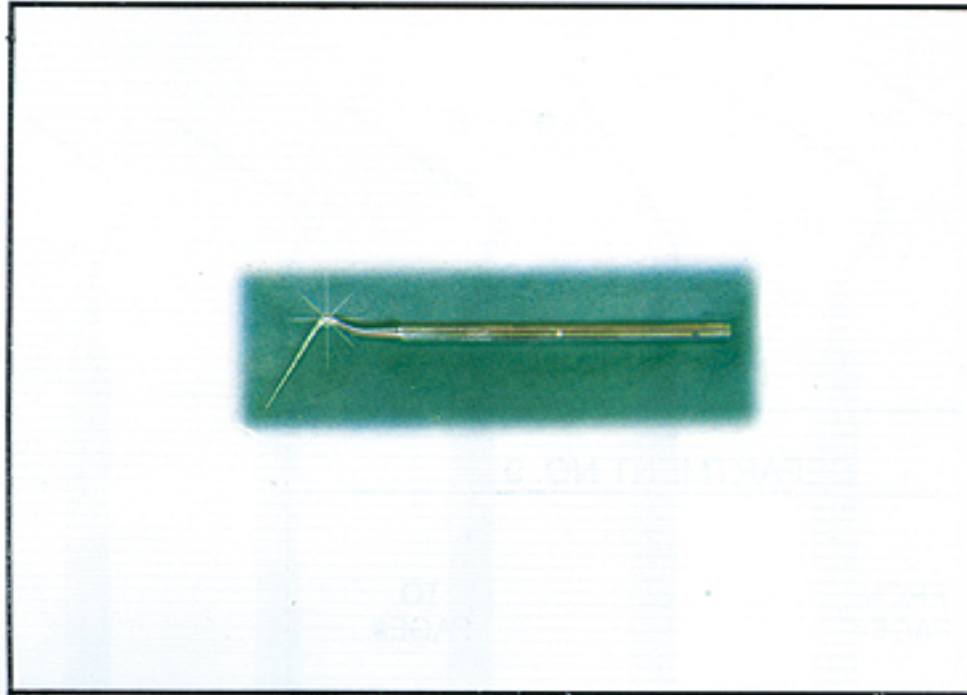

DEPARTMENT NO. 9

FROM
PAGE#

151

TO
PAGE#

154

INSTRUMENTS CATEGORY

ENDODONTIC AND NERVE INSTRUMENTS
INSTRUMENTS A NERFS
NERVINSTRUMENTE

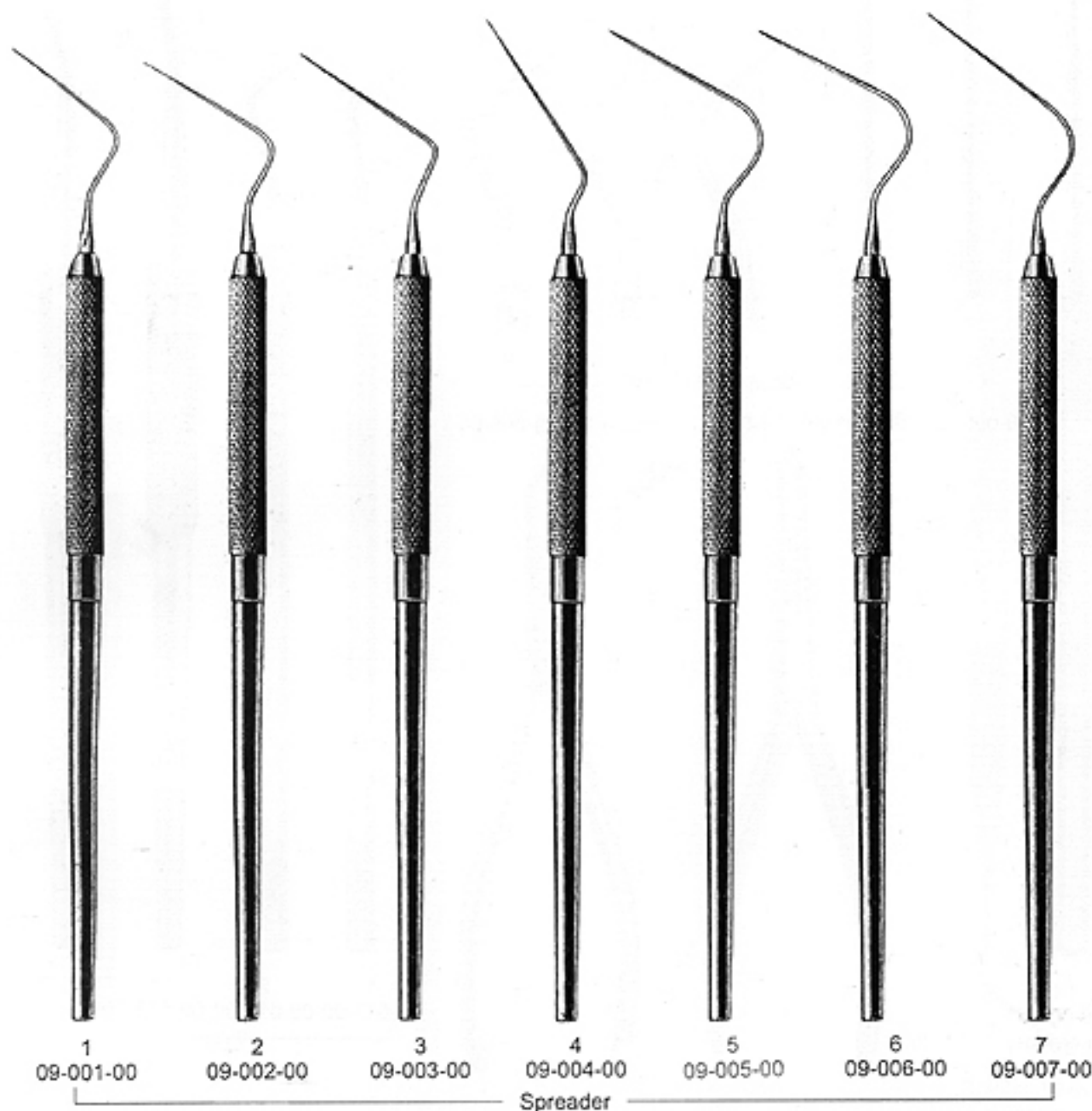

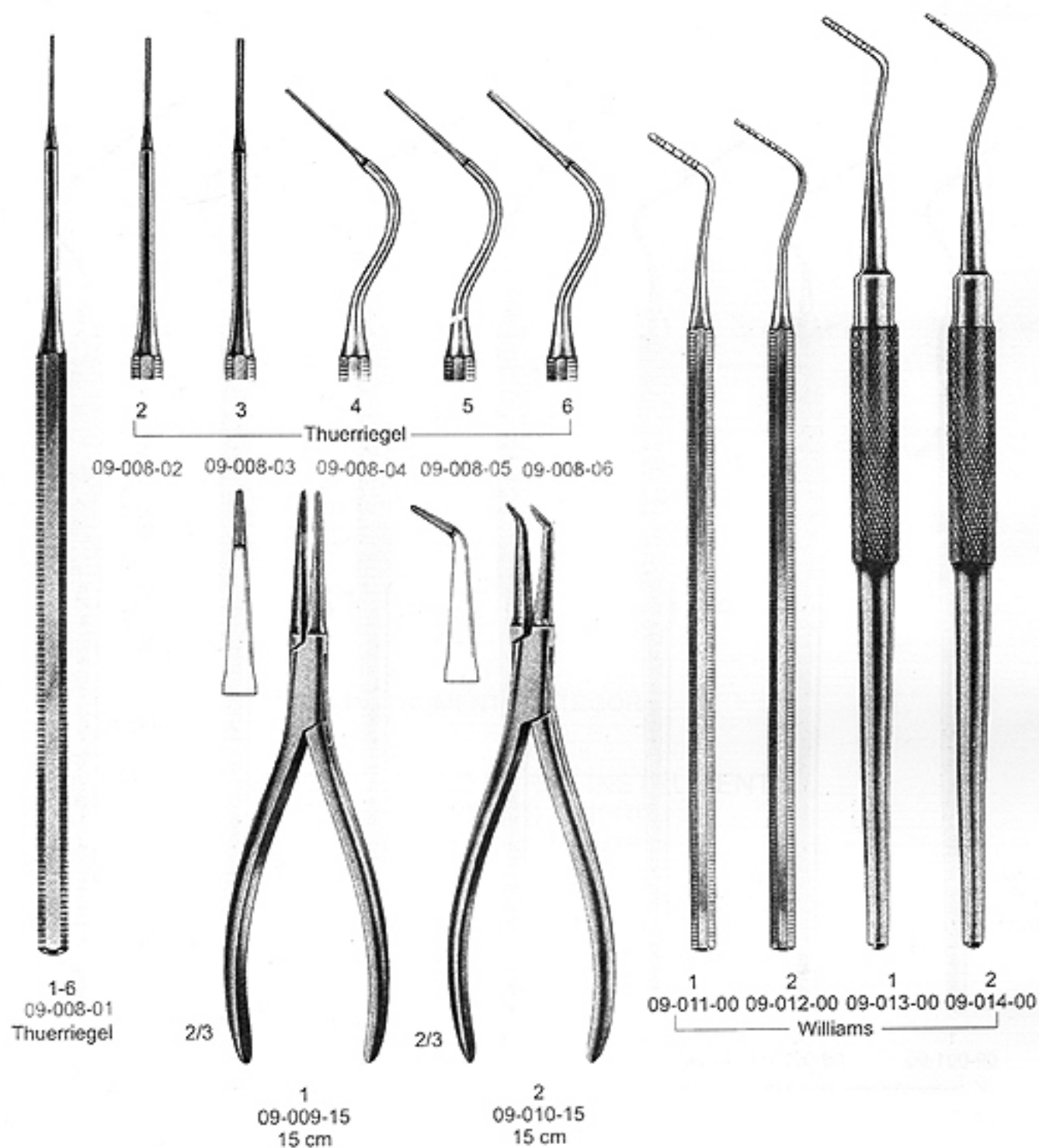



PERIODONTAL POCKET PROBES
PARODONTOMETER
SONDAS CALIBRADAS

09



Williams
09-015-00



Goldman-Fox
09-016-00



Goldman-Fox
Williams
09-017-00



Goldman-Fox
Williams
09-018-00

PERIODONTAL POCKET PROBES
PARODONTOMETER
SONDAS CALIBRADAS



ARAIN



Off Set
Williams De
09-019-00



Nabers
09-020-00



23/QW
Williams
09-021-00



09-022-00



ENDODONTIC AND NERVE INSTRUMENTS
INSTRUMENTS A NERFS
NERVINSTRUMENTE

09



09-030-01

09-031-02

09-032-03

09-033-04

Explorer
23
09-045-23

Department

10

CEMENT SPATULAS
SPATULE A CIMENT
ESPATULAS PARA CEMENTO

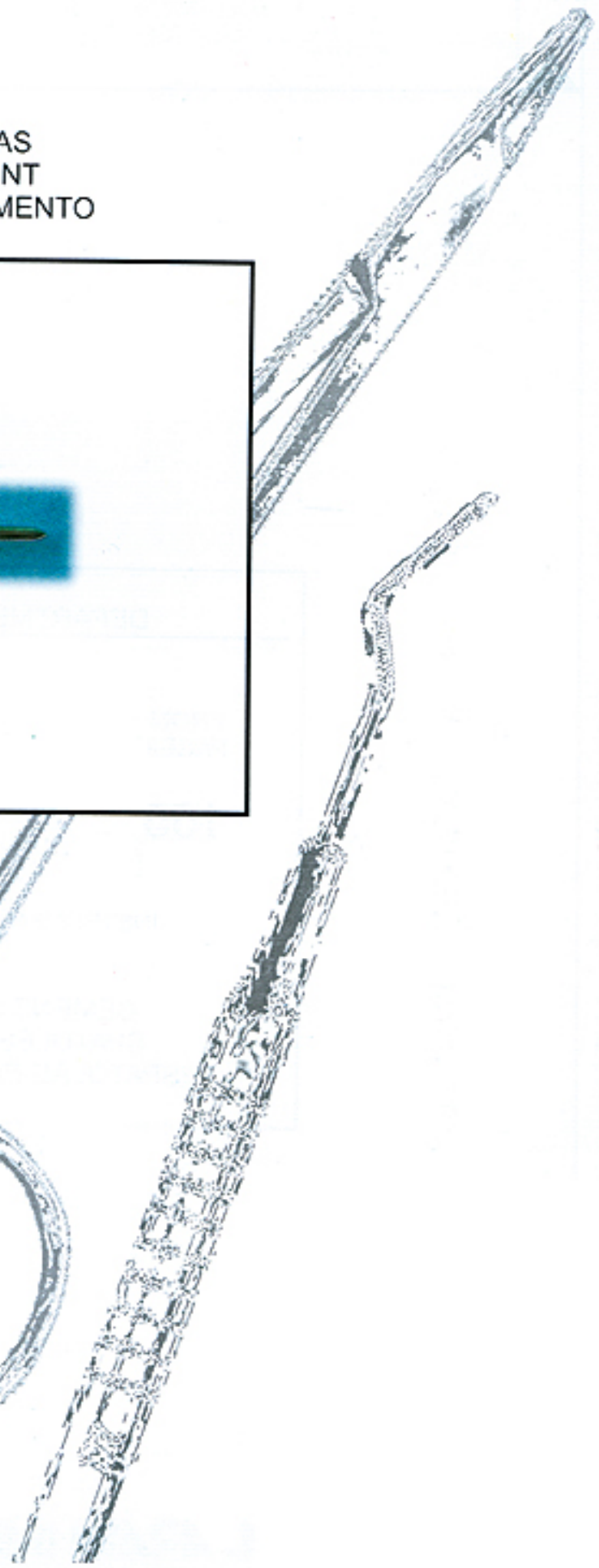
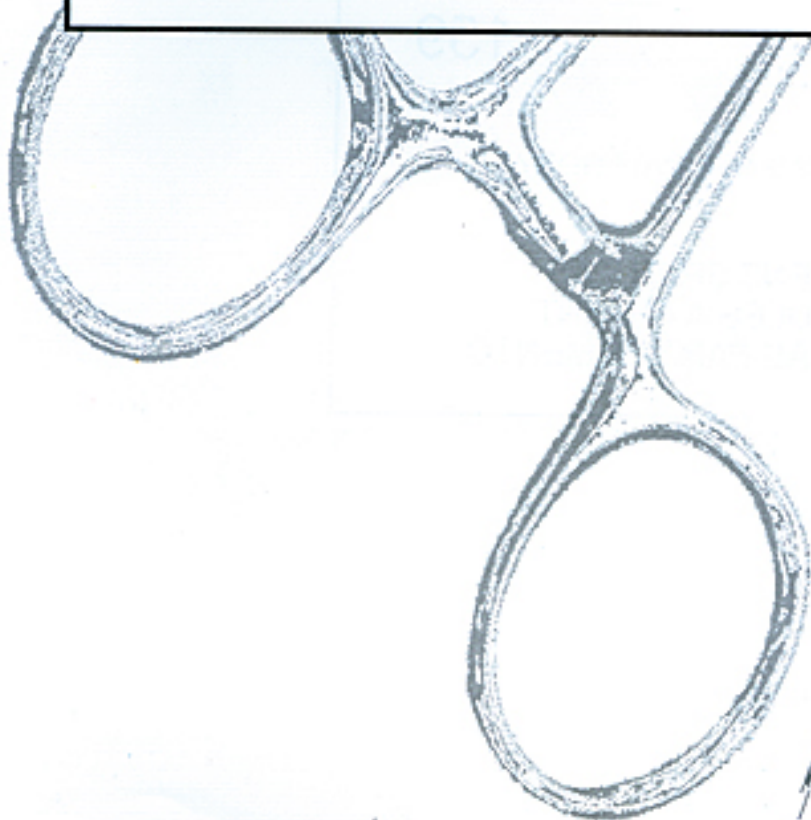
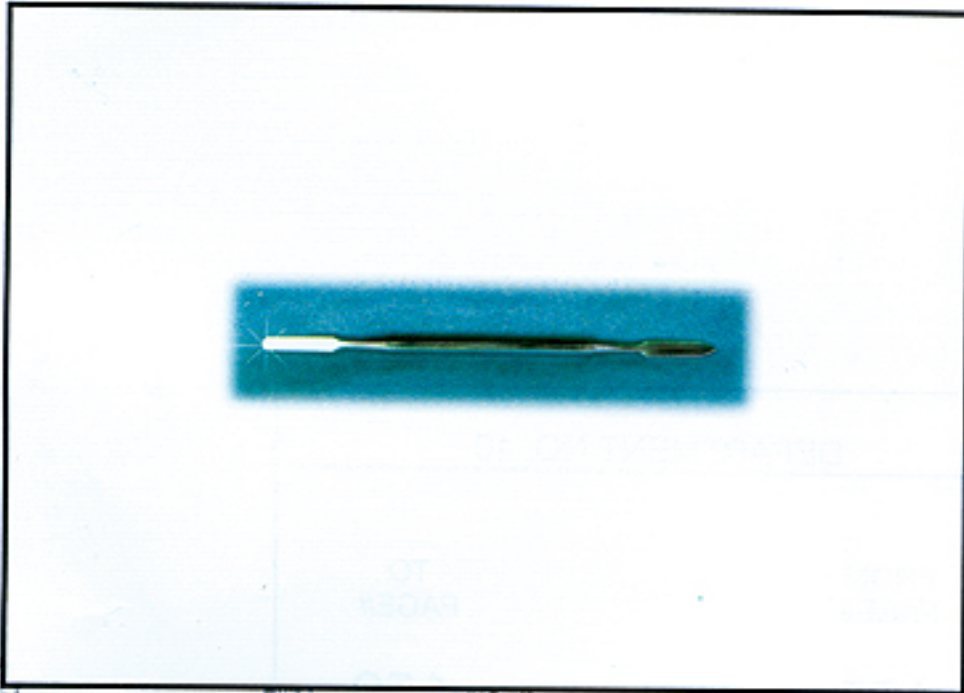



Basic Set in Pouch Consisting of Following Instruments

Mirror No. 5 with handle

Excavator No. 17

Explorer No. 5

College Tweezer Serrated 15 cm

09-051-00

DEPARTMENT NO. 10

FROM
PAGE#

155

TO
PAGE#

159

INSTRUMENTS CATEGORY

CEMENT SPATULAS
SPATULES A CIMENT
ESPATULAS PARA CEMENTO

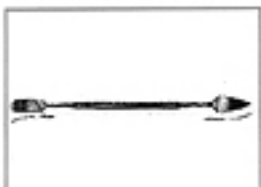

CEMENT SPATULAS
 SPATULES A CIMENT
 ESPATULAS PARA CEMENTO

10

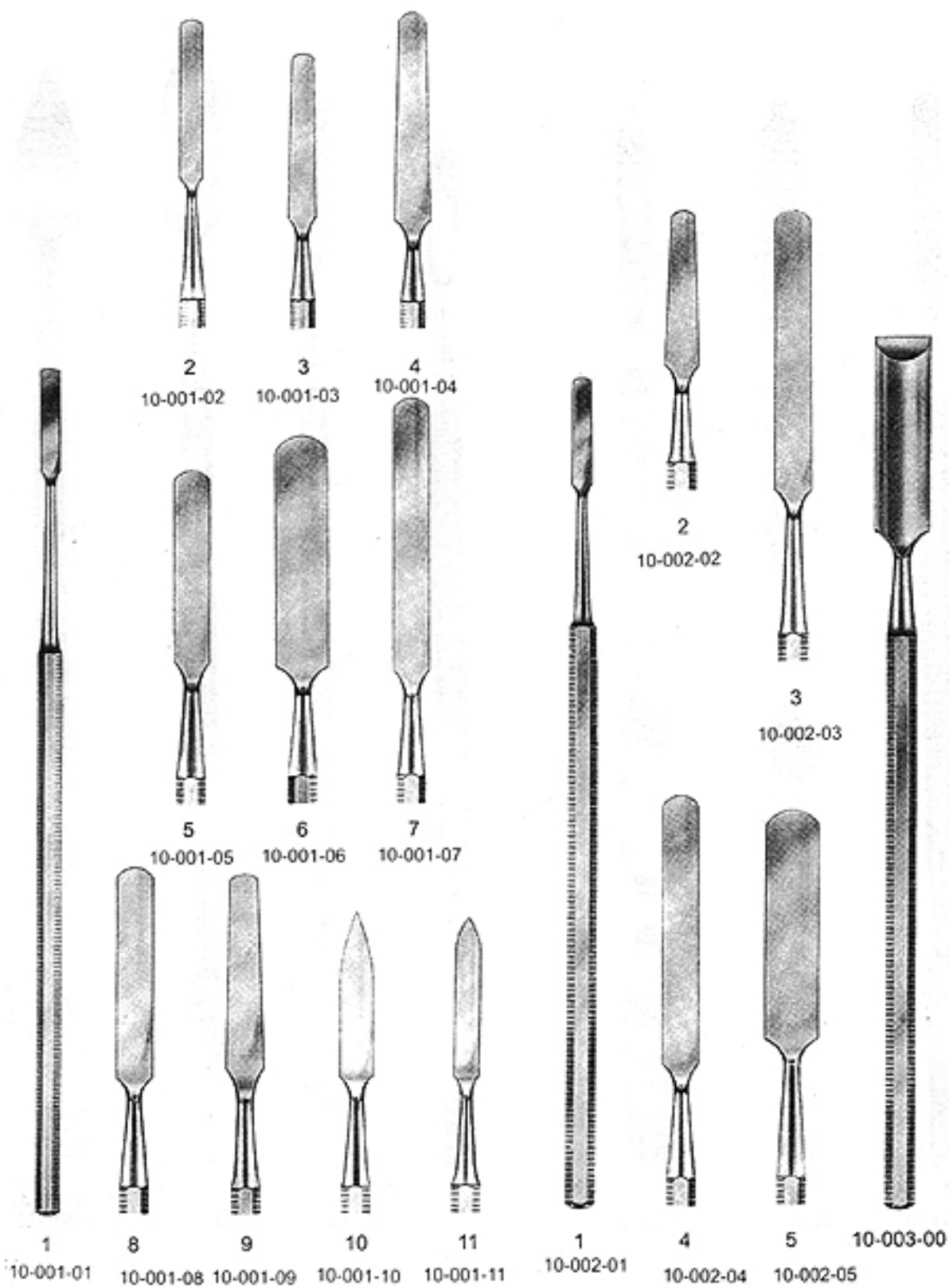

CEMENT SPATULAS
SPATULES A CIMENT
ESPATULAS PARA CEMENTO



1
10-004-01



2
10-004-02



3
10-004-03



4
10-004-04



5
10-004-05



1
10-005-00



2
10-006-00

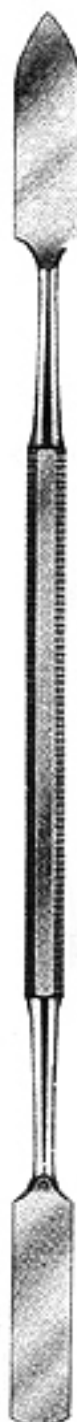

3
10-007-00

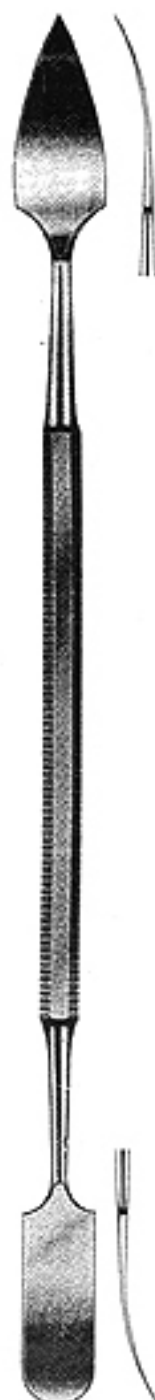

Gritman 31
10-008-00



AMALGAM INSTRUMENTS
 AMALGAM INSTRUMENTE
 INSTRUMENTOS PARA AMALGAM

10

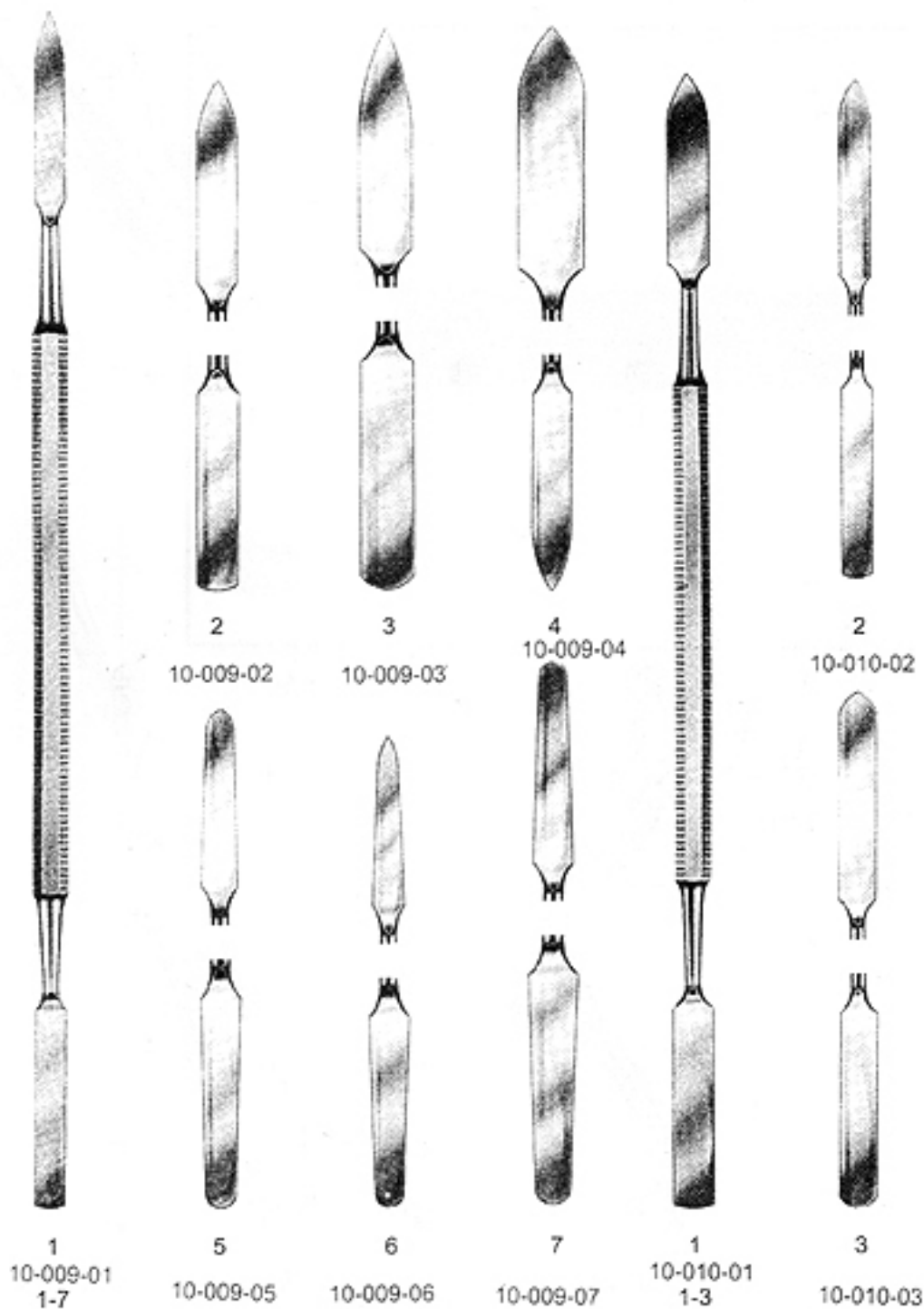

Department

11

AMALGAM INSTRUMENTS
AMALGAM INSTRUMENTE
INSTRUMENTOS PARA AMALGAM

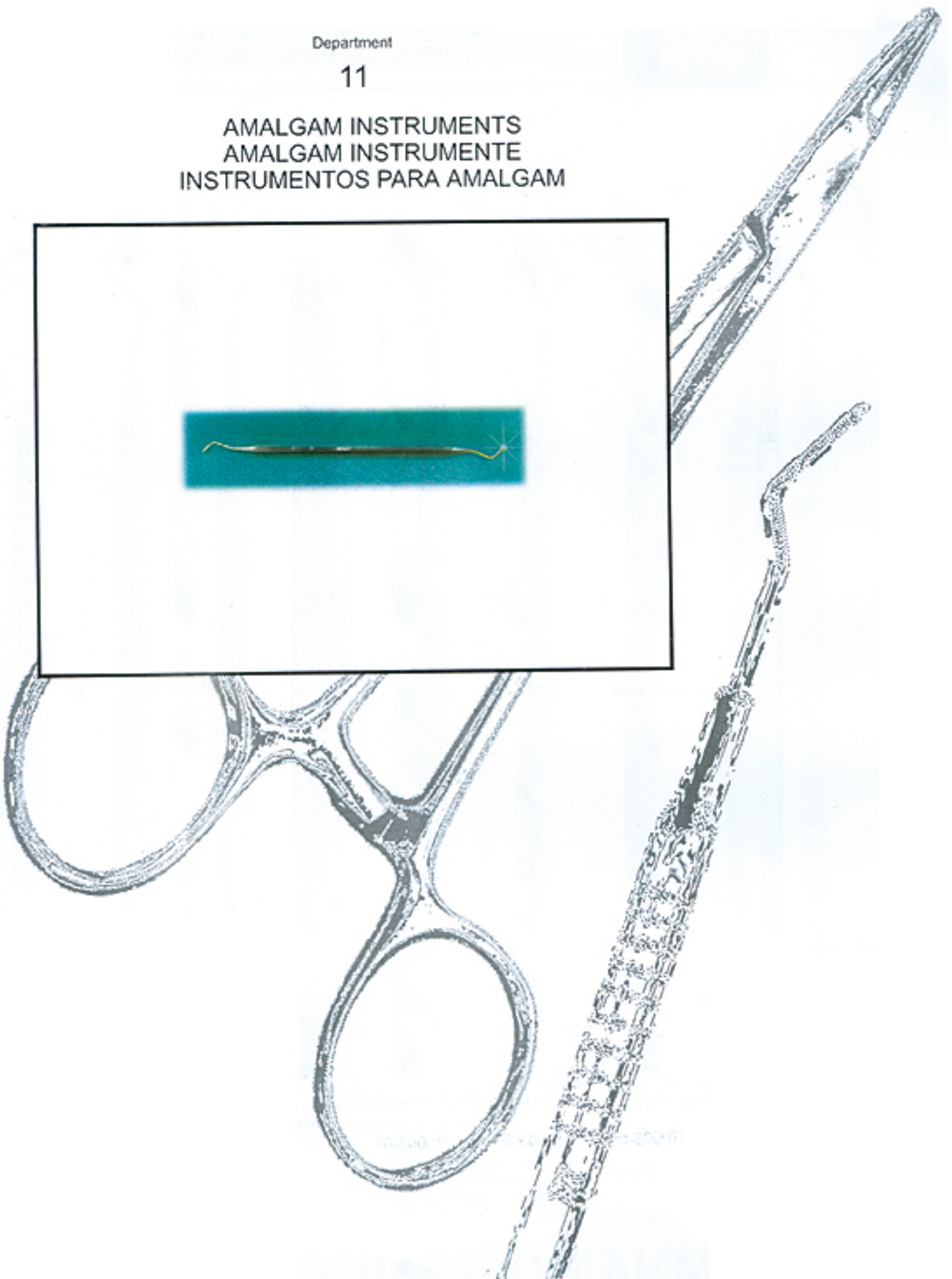
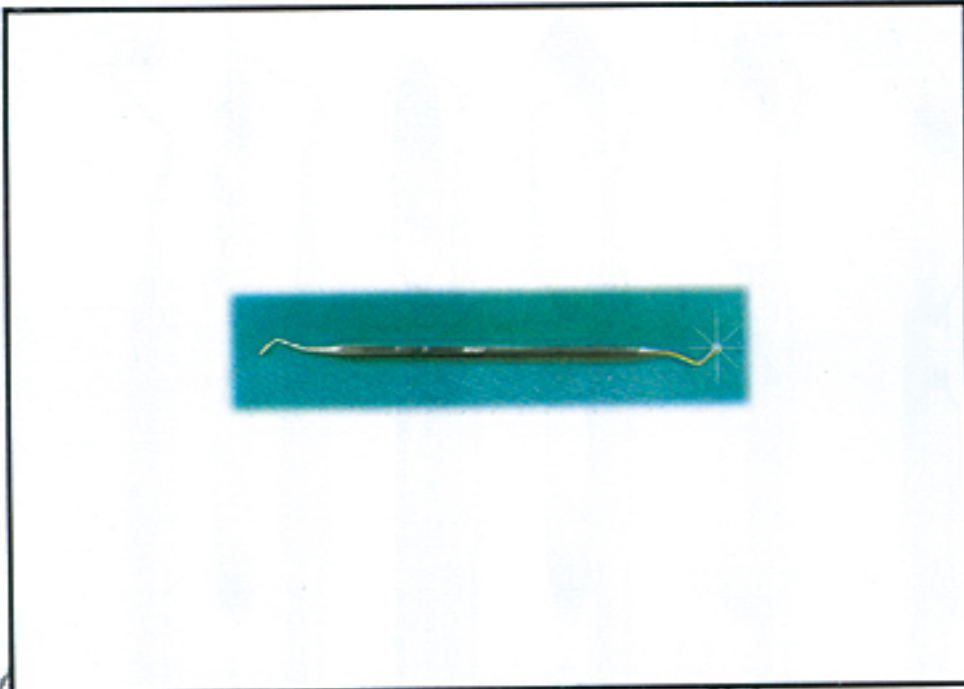

DEPARTMENT NO. 11

FROM
PAGE#

160

TO
PAGE#

168

INSTRUMENTS CATEGORY

AMALGAM INSTRUMENTS
AMALGAM INSTRUMENTE
INSTRUMENTOS PARA AMALGAM

CEMENT SPATULAS
SPATULE A CIMENT
ESPATULAS PARA CEMENTO

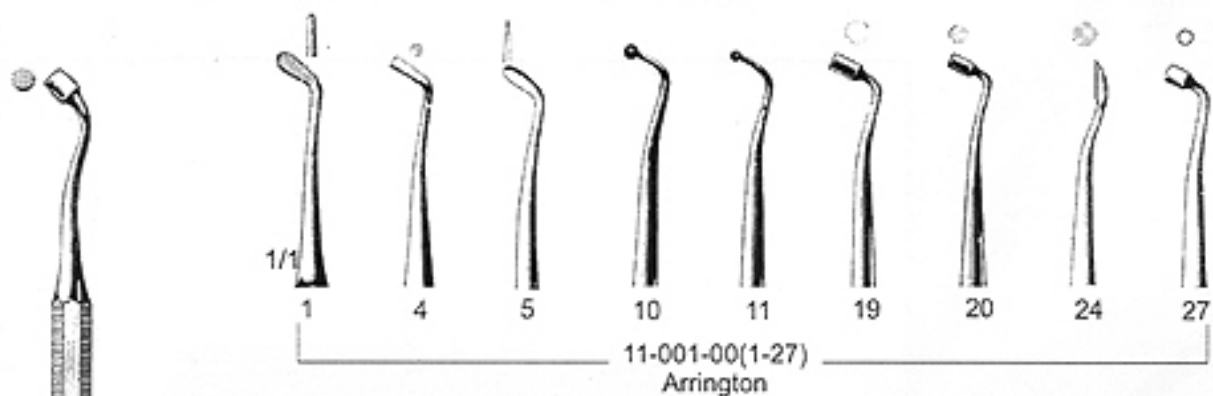

11-001-01 11-001-04 11-001-05 11-001-10 11-001-11 11-001-19 11-001-20 11-001-24 11-001-27

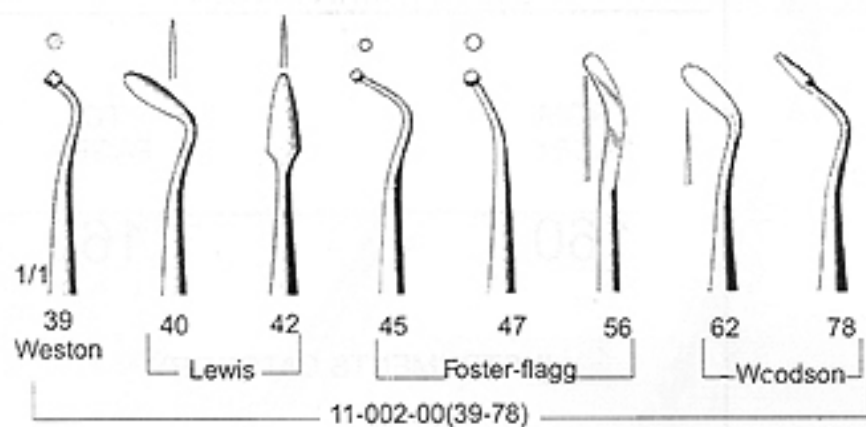

11-002-39 11-002-40 11-002-42 11-002-45 11-002-47 11-002-56 11-002-62 11-002-78

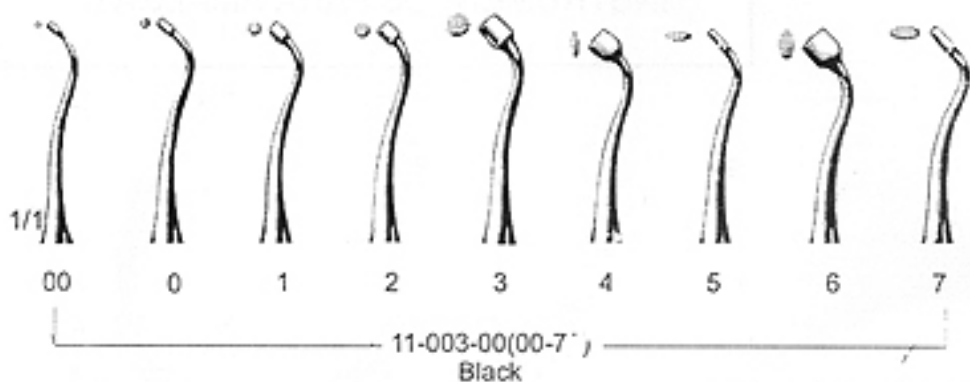

11-003-40 11-003-20 11-003-01 11-003-02 11-003-03 11-003-04 11-003-05 11-003-06 11-003-07

1
11-001-00(1-27)
11-002-00(39-78),
11-003-00(00-7)



AMALGAM INSTRUMENTS
 AMALGAM INSTRUMENTE
 INSTRUMENTOS PARA AMALGAM

11

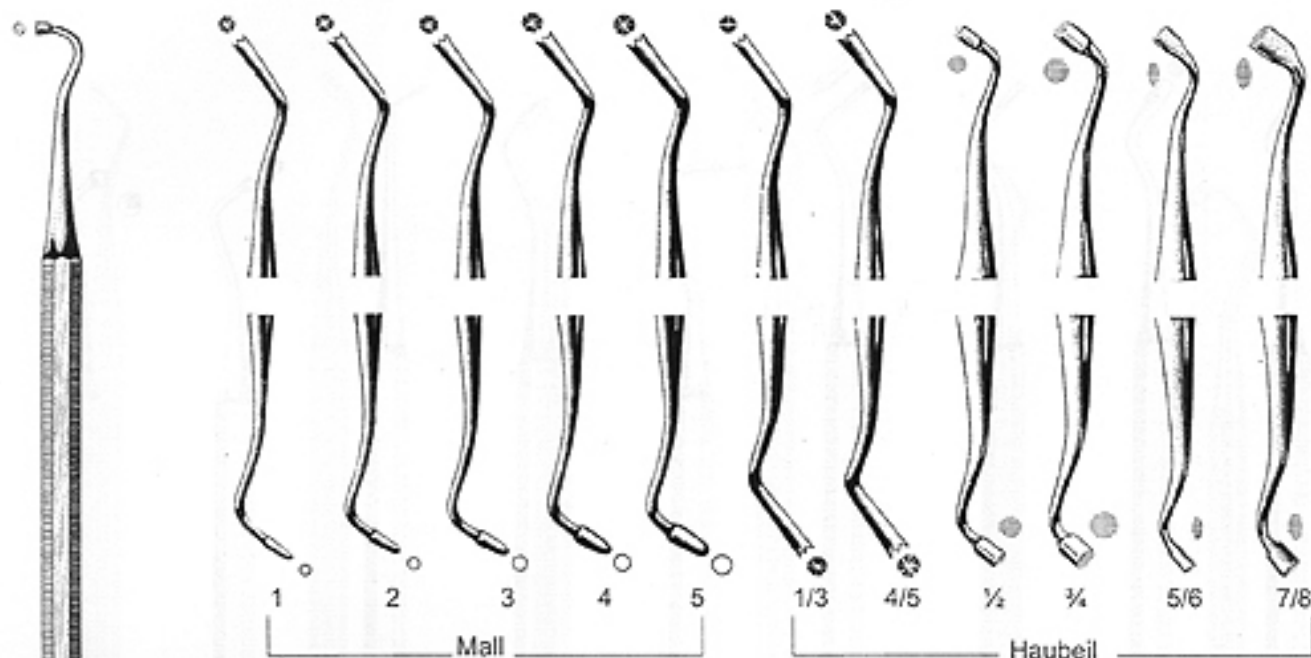

1

2

3

4

5

1/3

4/5

1/2

3/4

5/6

7/8

Mall

Haubeil

11-004-00(1-7/8)

11-004-01 11-004-02 11-004-03 11-004-04 11-004-05 11-004-1/3 11-004-4/5 11-004-1/2 11-004-3/4 11-004-5/6 11-004-7/8

1
 11-004-00(1-7/8)
 11-005-00(1-7)

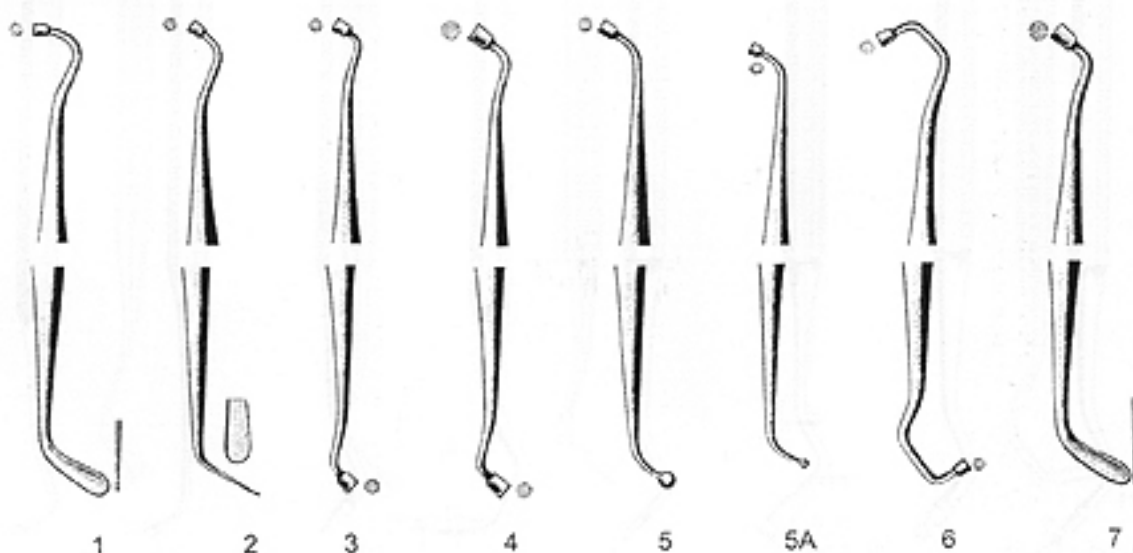

1

2

3

4

5

5A

6

7

11-005-00(1-7)
 Modell-Amalg

11-005-01 11-005-02 11-005-03 11-005-04 11-005-05 11-005-5A 11-005-06 11-005-07

AMALGAM INSTRUMENTS
 AMALGAM INSTRUMENTE
 INSTRUMENTOS PARA AMALGAM



ARAIN

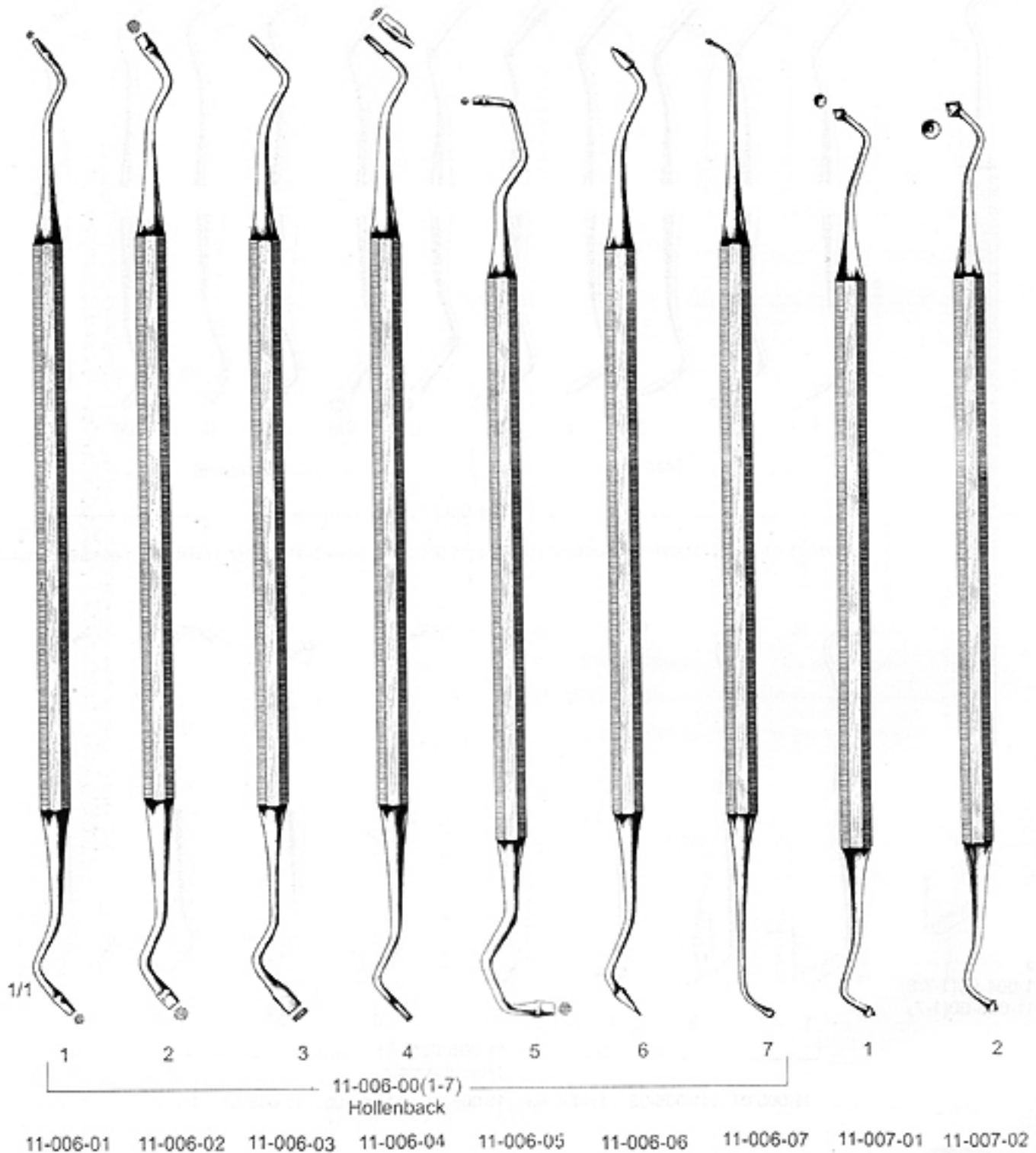



AMALGAM INSTRUMENTS
AMALGAM INSTRUMENTE
INSTRUMENTOS PARA AMALGAM

11



1-2
11-008-00



2-3
11-009-00

Black



1-2
11-010-00



3-4
11-011-00

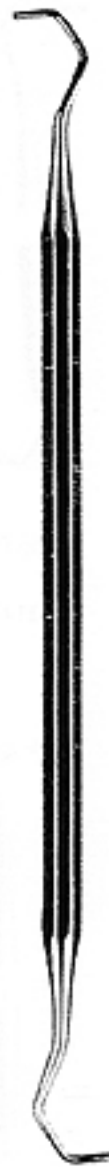

5-6
11-012-00

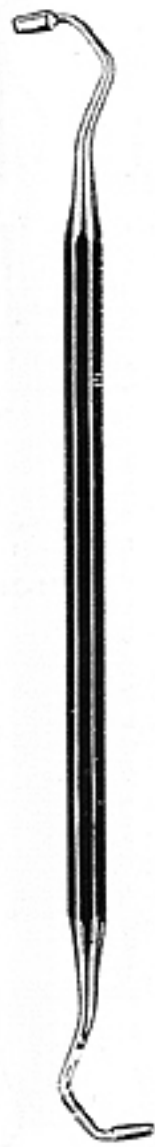

7-8
11-013-00

Linder

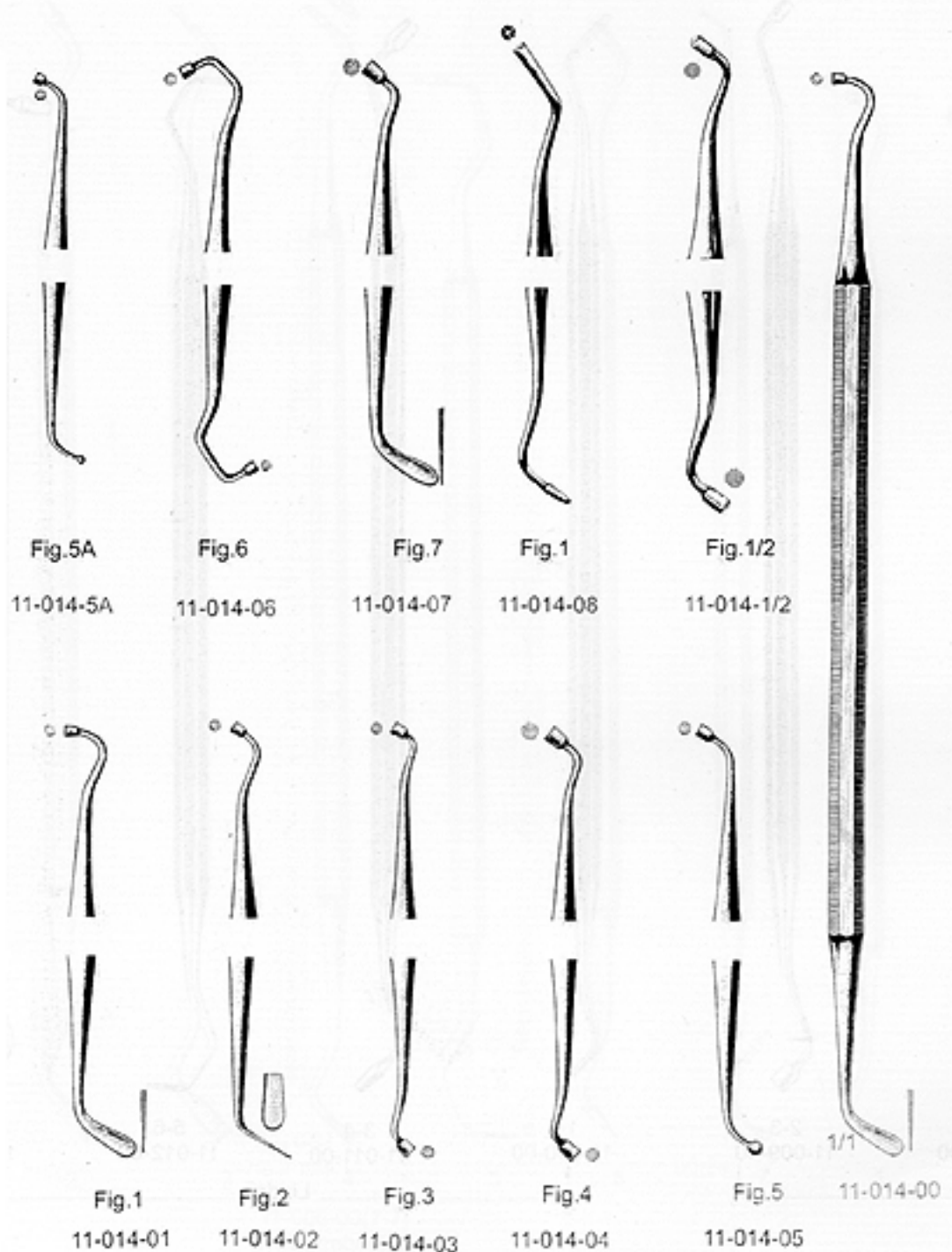
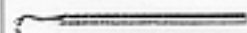



WA-4
11-015-00
Wallis-4



WI-4
11-016-00
William-4



11-017-00
Porcelain



11-018-00
Pelar Carver



11-019-00
Nystrom Cervical

AMALGAM CARVER
 INSTRUMENTE ZUM MODELLIEREN VON FULLUNGEN
 INSTRUMENTOS PARA MODELAR LAS OBTURACIONES



ARAIN

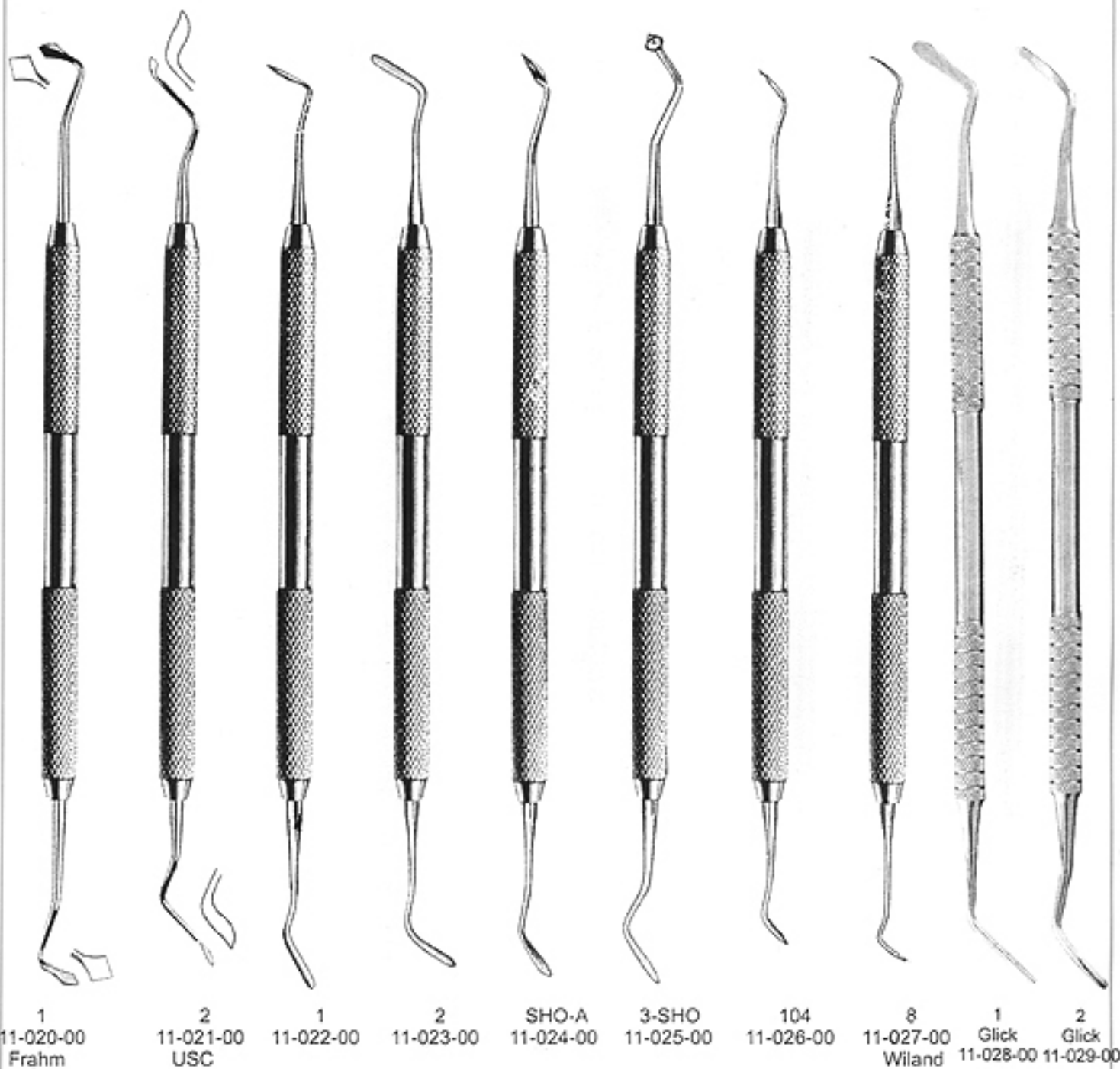

Department

12

BONE CURETTES
SCHARFE LOFFEL
CURETAS OSEAS

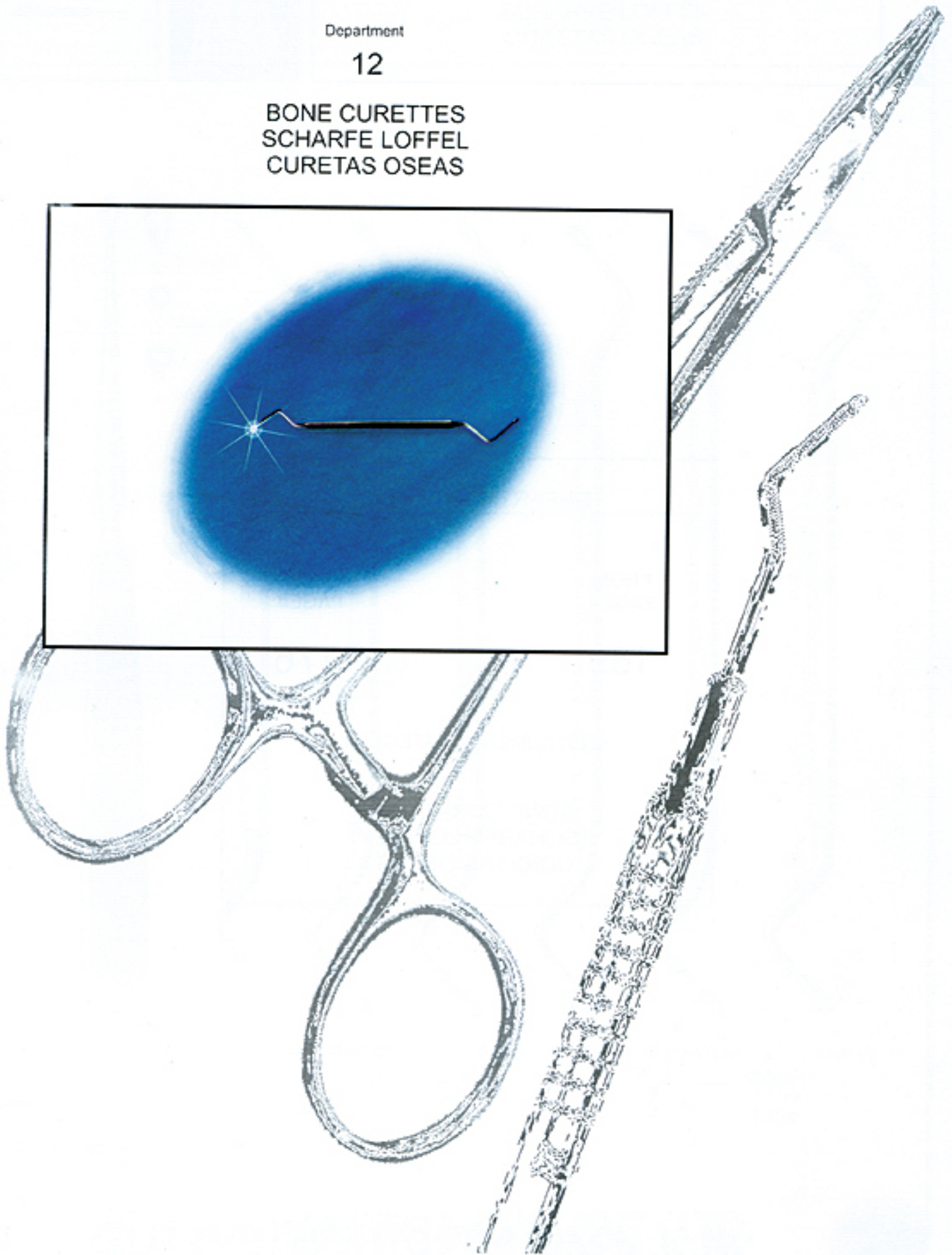

DEPARTMENT NO. 12

FROM
PAGE#

169

TO
PAGE#

176

INSTRUMENTS CATEGORY

BONE CURETTES
SCHARFE LOFFEL
CURETAS OSEAS



BONE CURETTES
SCHARFE LOFFEL
CURETAS OSEAS

12

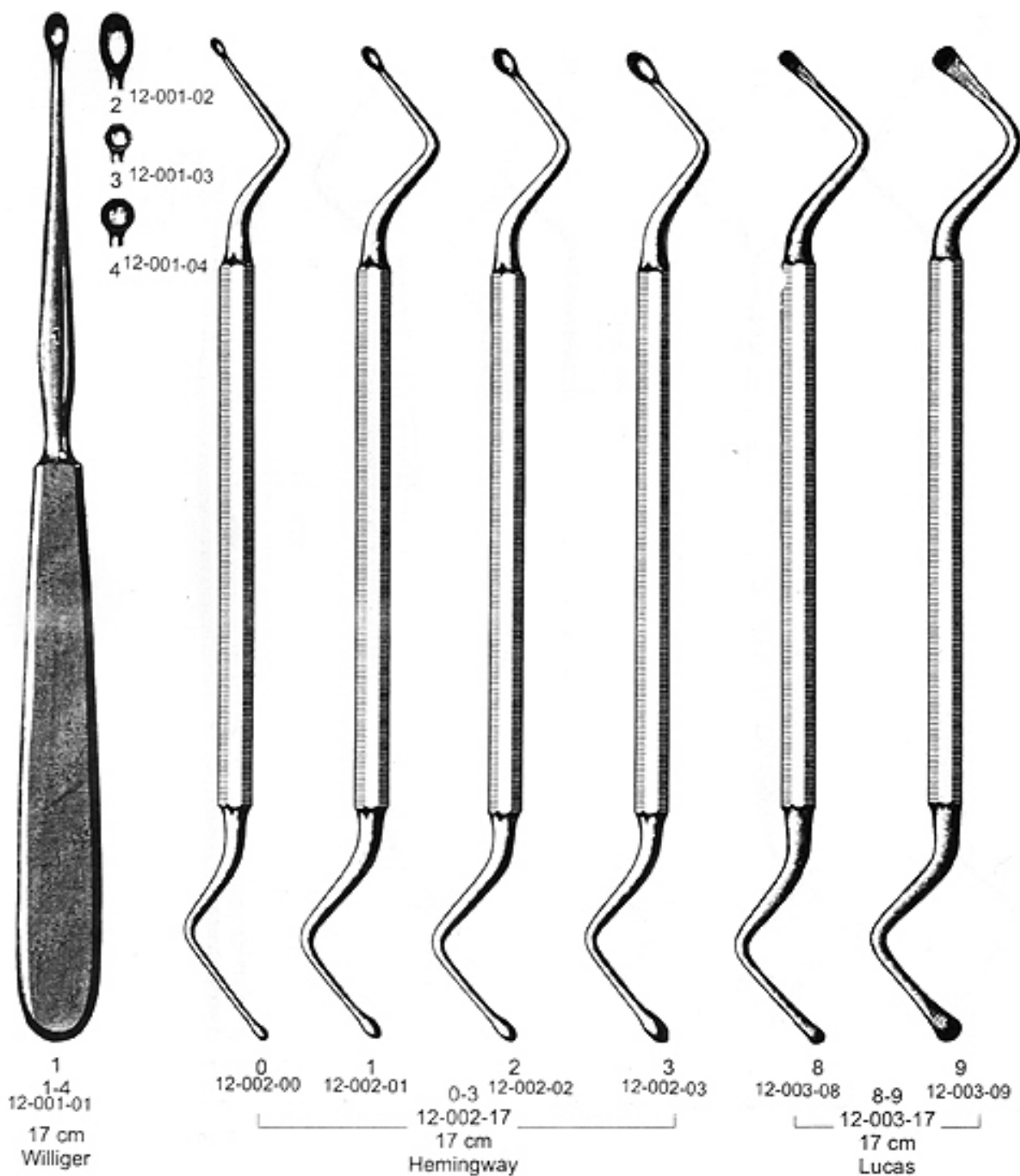

BONE CURETTES
SCHARFE LOFFEL
CURETAS OSEAS



ARAIN

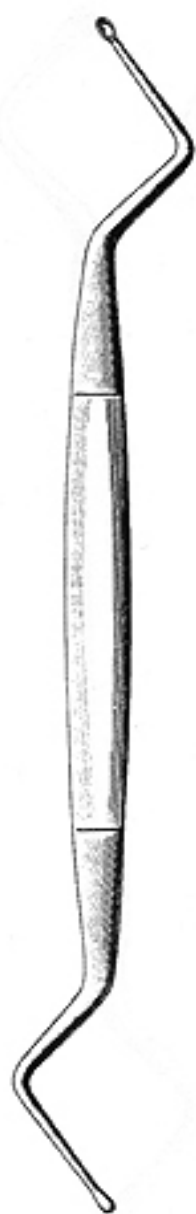

1
12-004-17
17 cm



2
12-005-17
17 cm

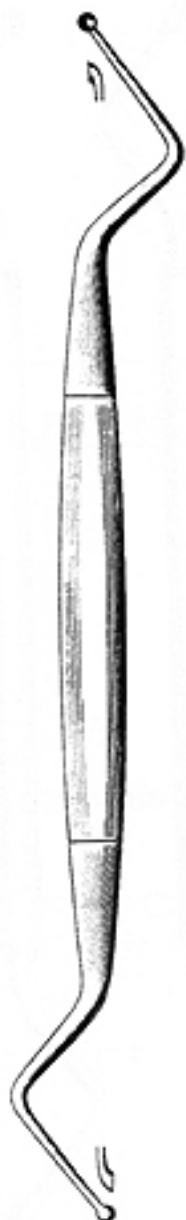

1
12-006-00



2
12-007-00

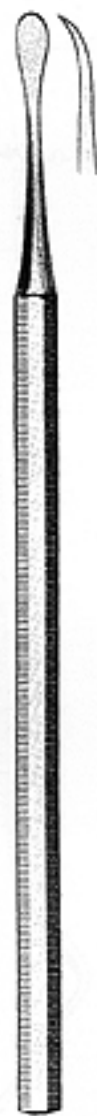

2
12-008-00
Partsch



12-009-17
17 cm



BONE CURETTES
SCHARFE LOFFEL
CURETAS OSEAS

12



12-010-16
16.5 cm
Molt



1

12-010-01



2

12-010-02



4

12-010-04



5L

12-010-5L



5R

12-010-5R



0/0

12-011-14
14 cm
Willger

12-011-0/0



0/1

12-011-0/1



0/2

12-011-0/2



0/0

12-012-14
14 cm
Martini

12-012-0/0



0/1

12-012-0/1



0/2

12-012-0/2



12-013-17
17.5 cm
Williger

BONE CURETTES
SCHARFE LOFFEL
CURETAS OSEAS



0000 000 00 0
12-014-40 12-014-30 12-014-20 12-014-10

1 2 3
12-014-01 12-014-02 12-014-03

12-014-17
17 cm
Volkman



1L 1R
12-015-1L 12-015-1R



1
12-015-16
16 cm
U.S.A. Model

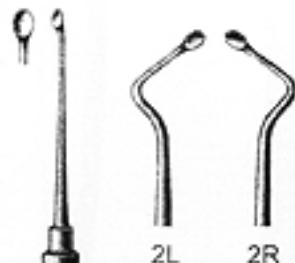

2L 2R
12-016-2L 12-016-2R



2
12-016-16
16 cm
U.S.A. Model



BONE CURETTES
SCHARFE LOFFEL
CURETAS OSEAS

12



1-8
12-017-14
14 cm
Kerpel



2

17-017-02



3

17-017-03



5

17-017-05



7

12-017-07



8

12-017-08



1-8
12-018-14
14 cm



1

12-018-01



4

12-018-04



5

12-018-05



7

12-018-07



8

12-018-08

BONE CURETTES
SCHARFE LOFFEL
CURETAS OSEAS



ARAIN

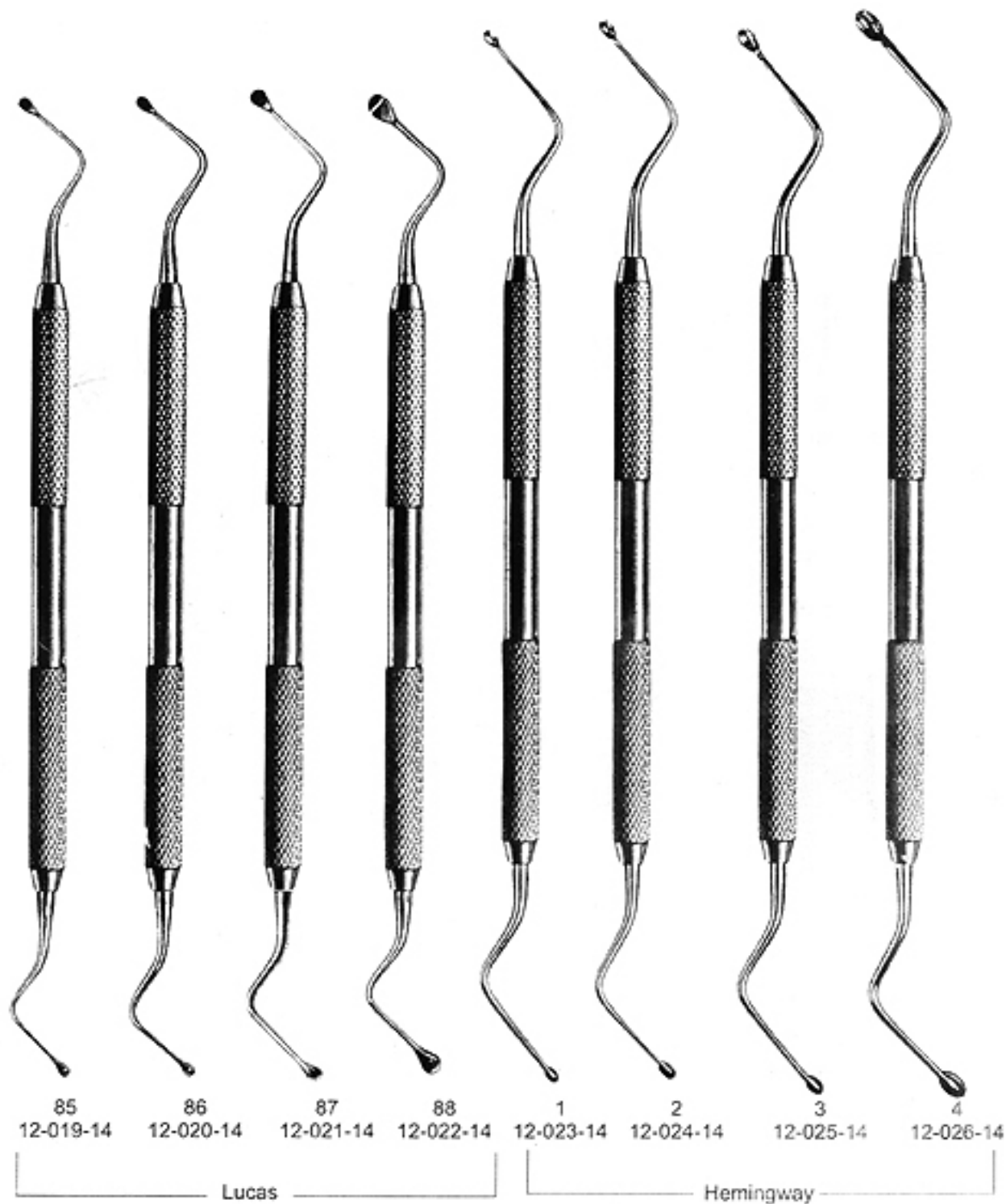

Department

13

FILLING INSTRUMENTS
INSTRUMENTS POUR PLOMBAGE
INSTRUMENTOS PARA OBTURACIONES

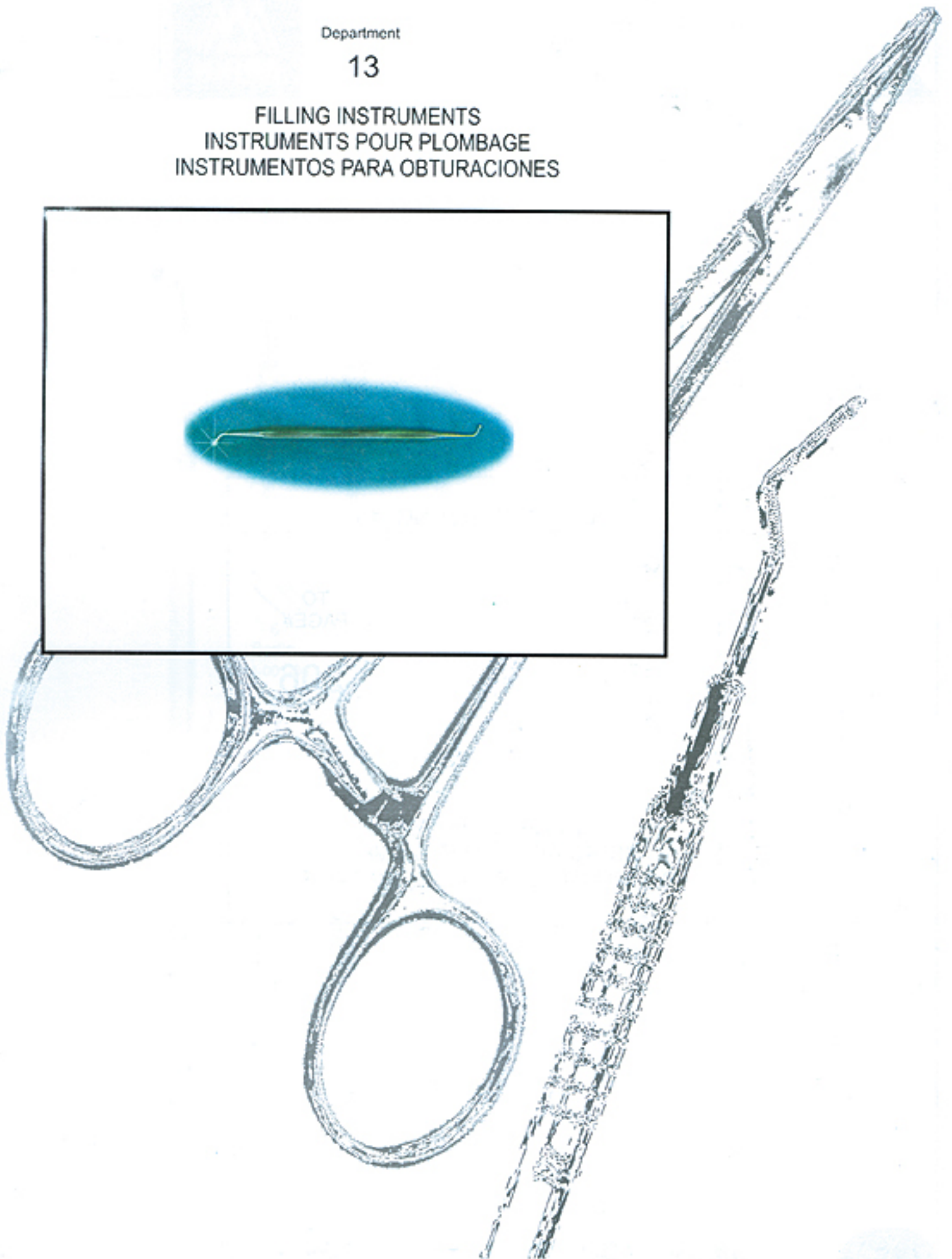
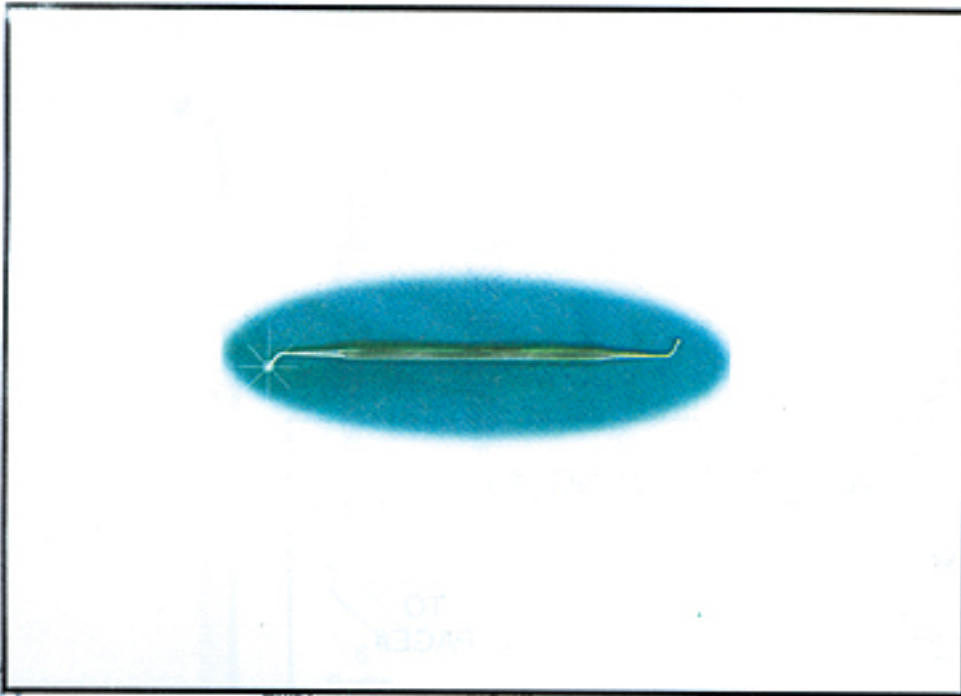

DEPARTMENT NO. 13

FROM
PAGE#

177

TO
PAGE#

206

INSTRUMENTS CATEGORY

FILLING INSTRUMENTS
INSTRUMENTS POUR PLOMBAGE
INSTRUMENTOS PARA OBTURACIONES

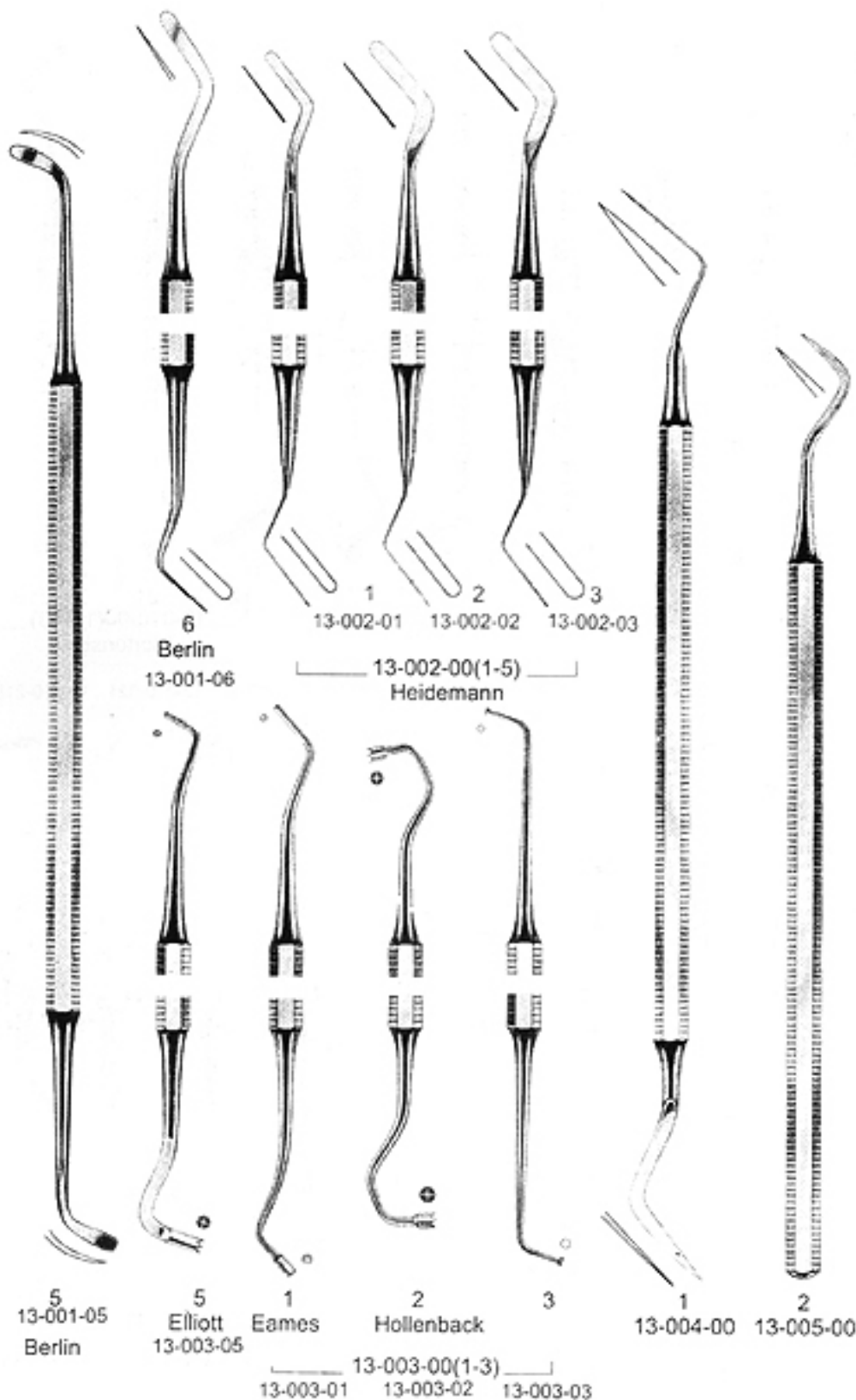

FILLING INSTRUMENTS
INSTRUMENTS POUR PLOMBAGE
INSTRUMENTOS PARA OBTURACIONES

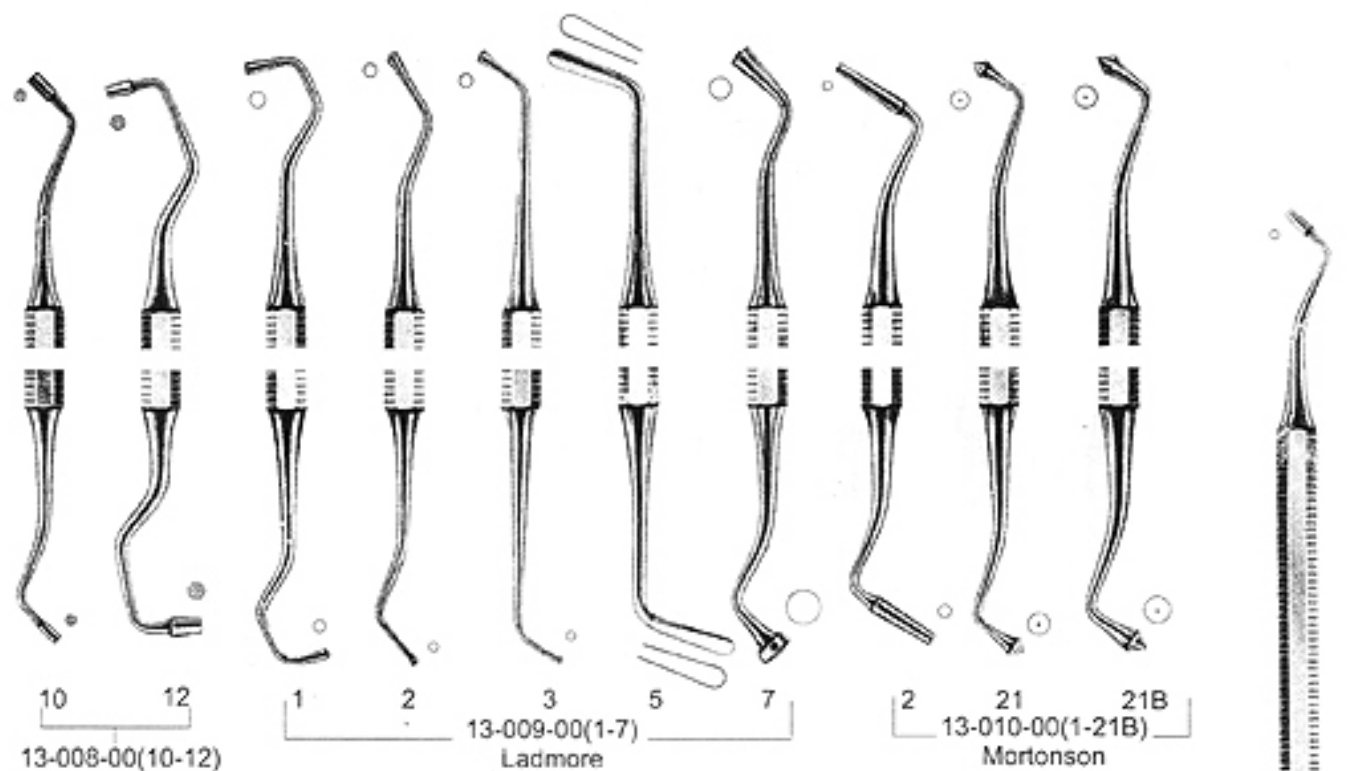
13-008-10 13-008-12 13-009-01 13-009-02 13-009-03 13-009-05 13-009-07 13-010-02 13-010-021 13-010-21B

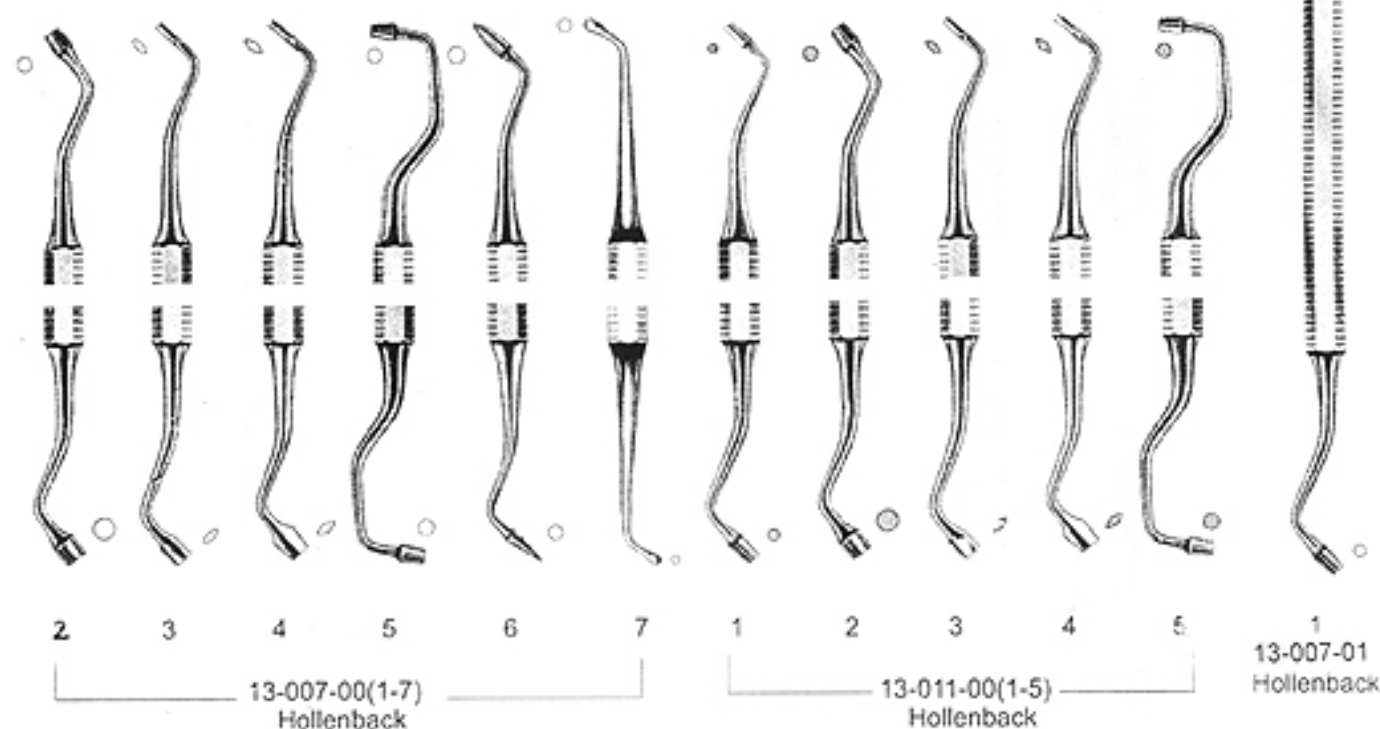

13-007-02 13-007-03 13-007-04 13-007-05 13-007-06 13-007-07 13-011-01 13-011-02 13-011-03 13-011-04 13-011-05



FILLING INSTRUMENTS
 INSTRUMENTS POUR PLOMBAGE
 INSTRUMENTOS PARA OBTURACIONES

13

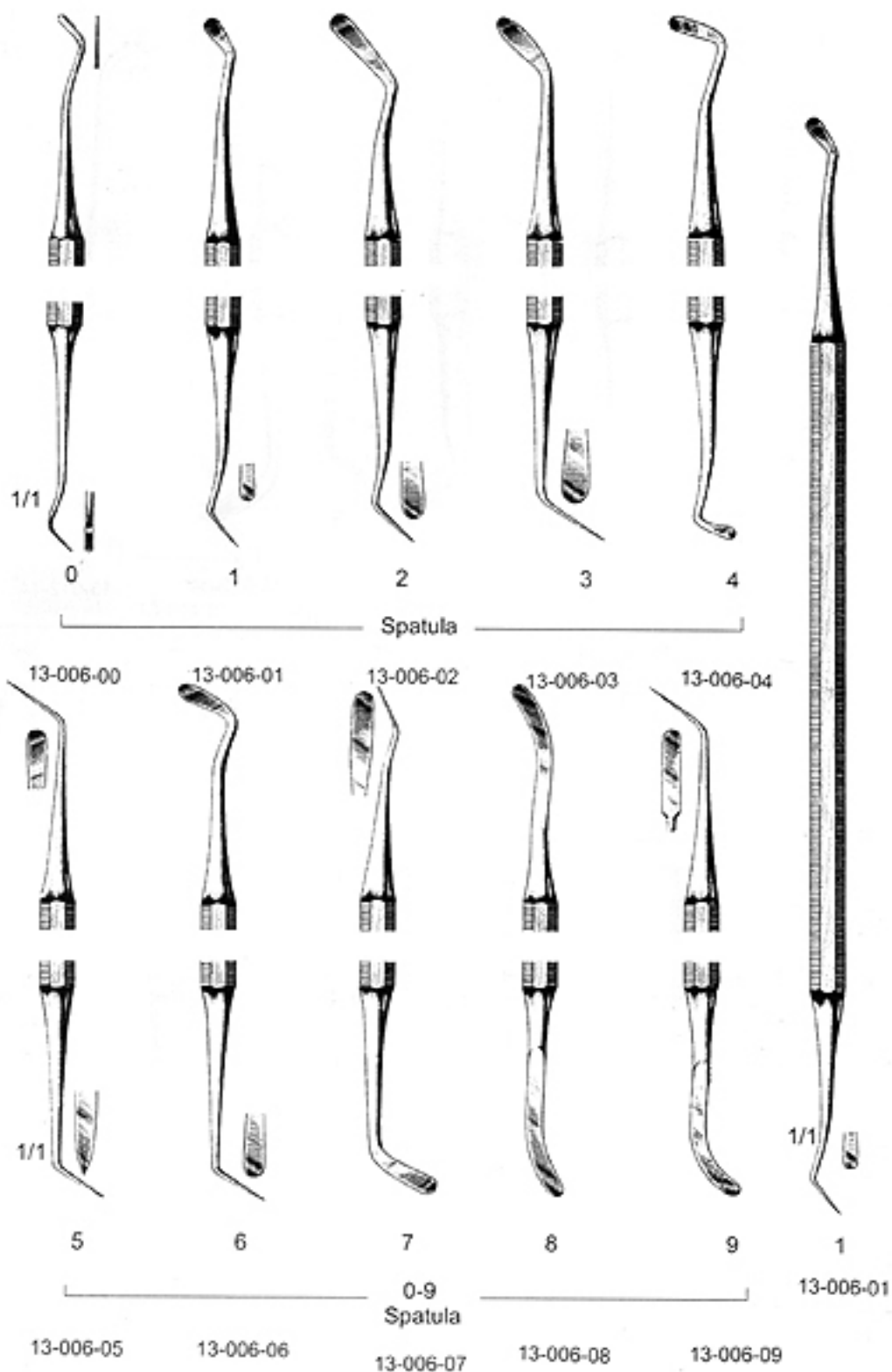

FILLING INSTRUMENTS
INSTRUMENTS POUR PLOMBAGE
INSTRUMENTOS PARA OBTURACIONES

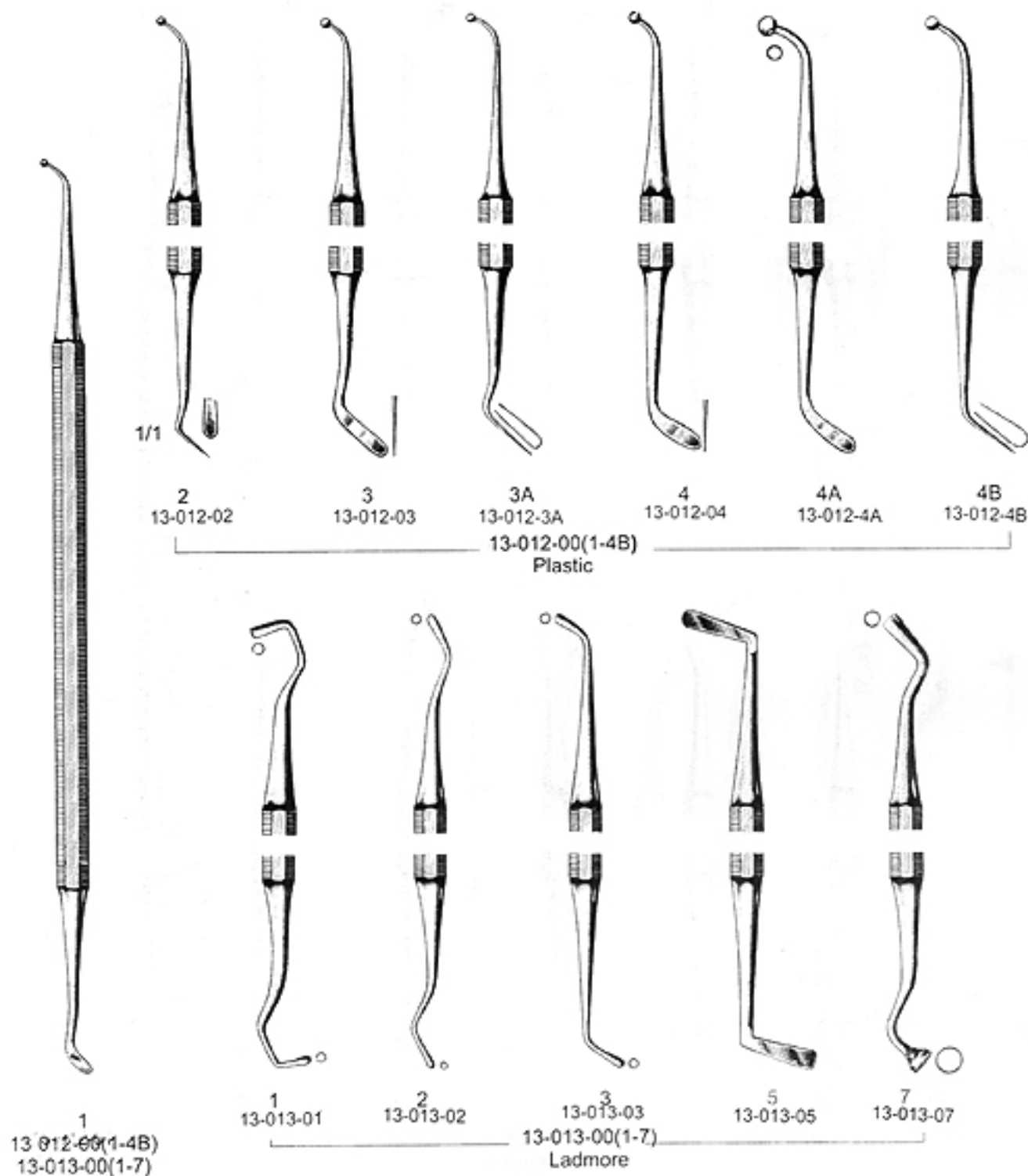

FILLING INSTRUMENTS
INSTRUMENTS POUR PLOMBAGE
INSTRUMENTOS PARA OBTURACIONES

13

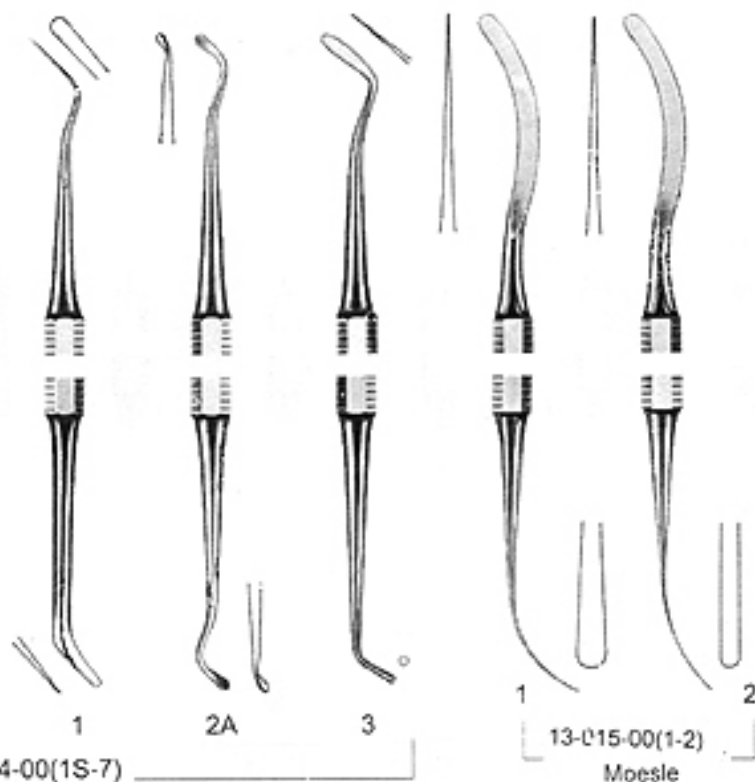

White

Moesle

13-014-01

13-014-2A

13-014-03

13-015-A1

13-015-A2

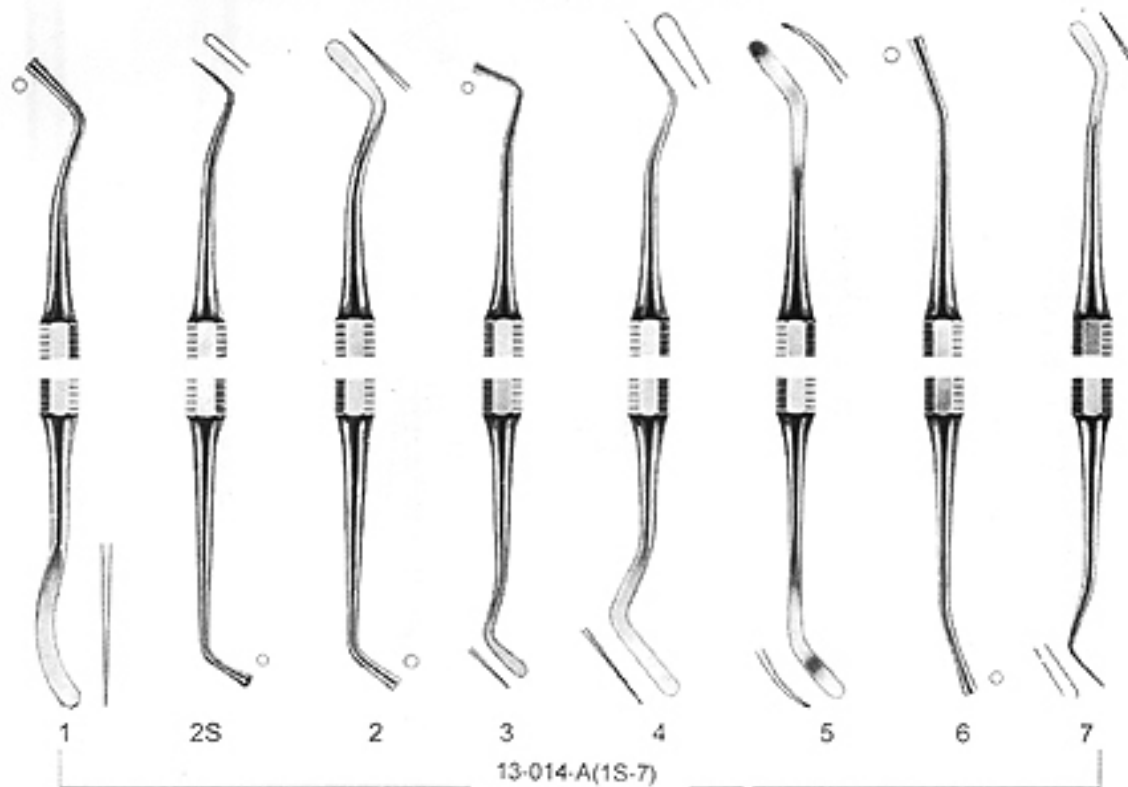

13-014-A1 13-014-2S 13-014-A2 13-014-A3

13-014-A4 13-014-A5 13-014-A6 13-014-A7

M. A. ARAIN & BROTHERS (PVT.) LTD.

183

FILLING INSTRUMENTS
INSTRUMENTS POUR PLOMBAGE
INSTRUMENTOS PARA OBTURACIONES

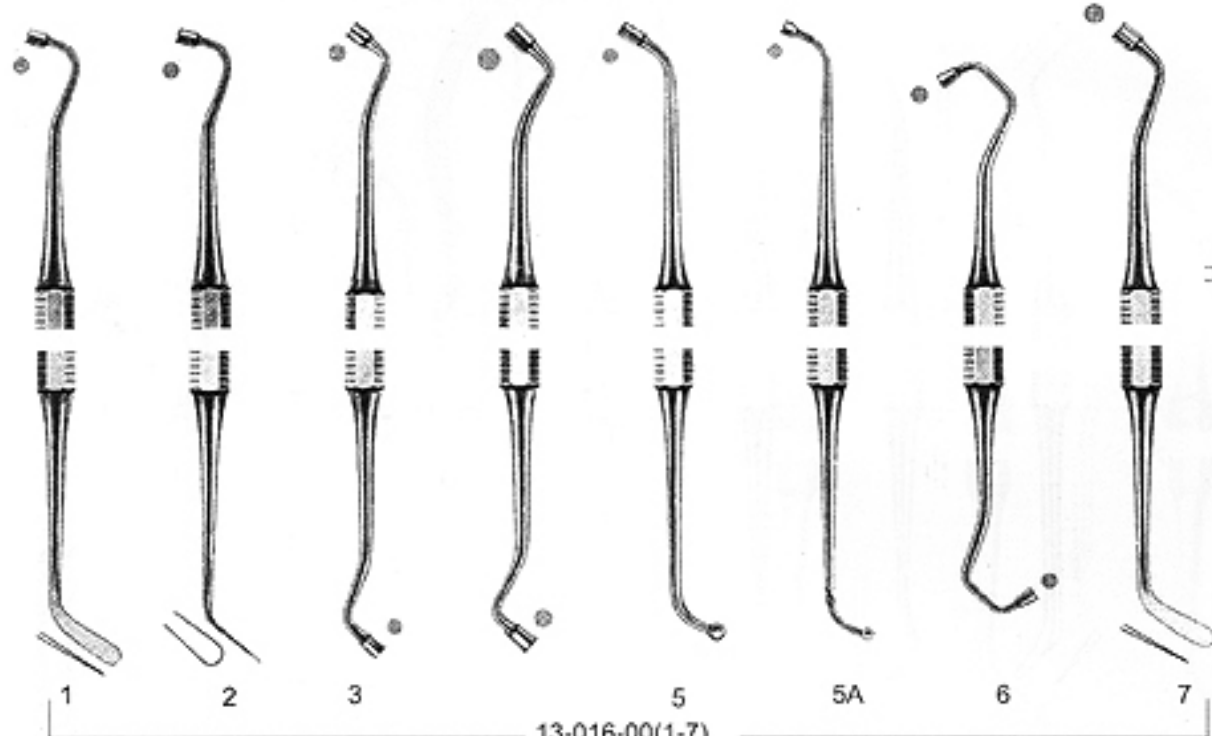
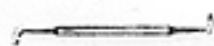
13-016-00(1-7)
Biber

13-016-01 13-016-02 13-016-03 13-016-04 13-016-05 13-016-5A 13-016-06 13-016-07

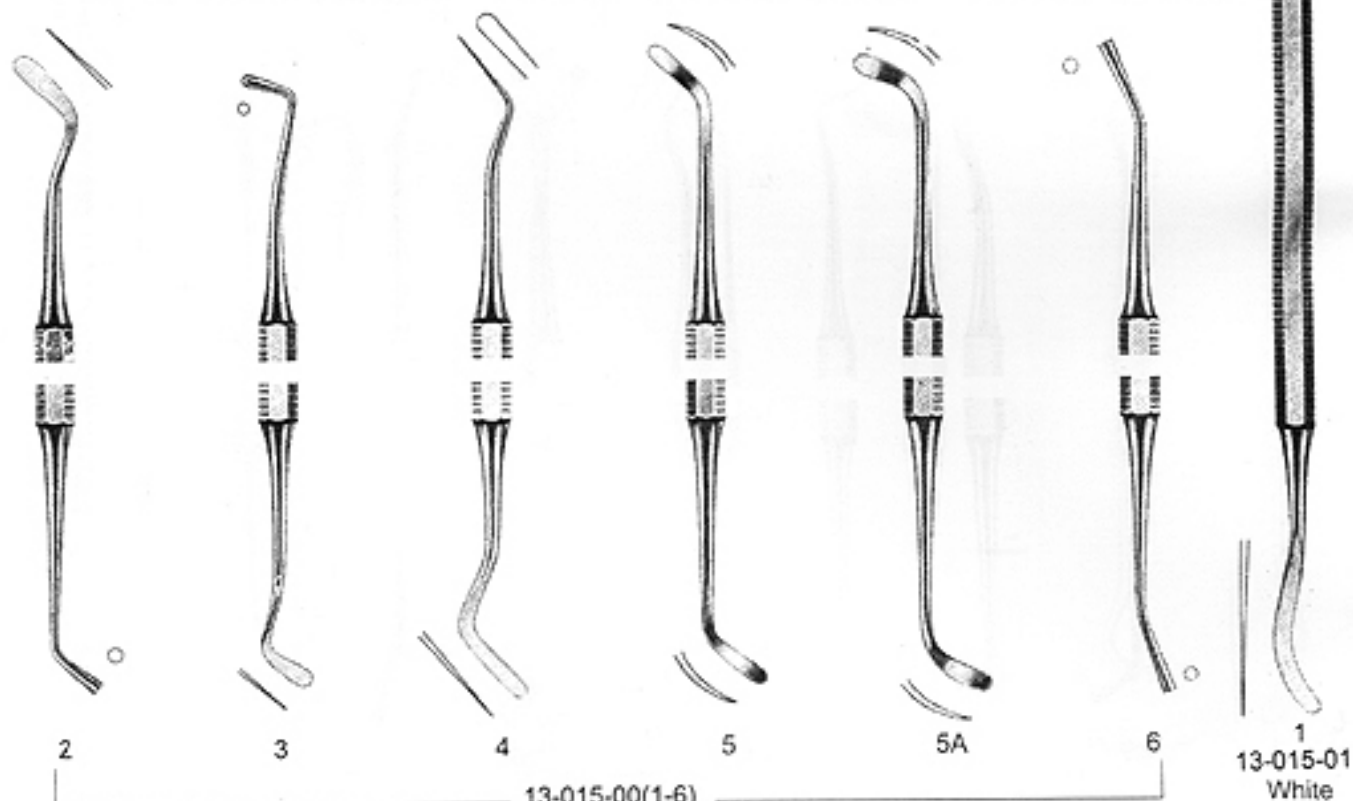

13-015-00(1-6)
White

13-015-02 13-015-03 13-015-04 13-015-05 13-015-05A 13-015-06

1
13-015-01
White



FILLING INSTRUMENTS
 INSTRUMENTS POUR PLOMBAGE
 INSTRUMENTOS PARA OBTURACIONES

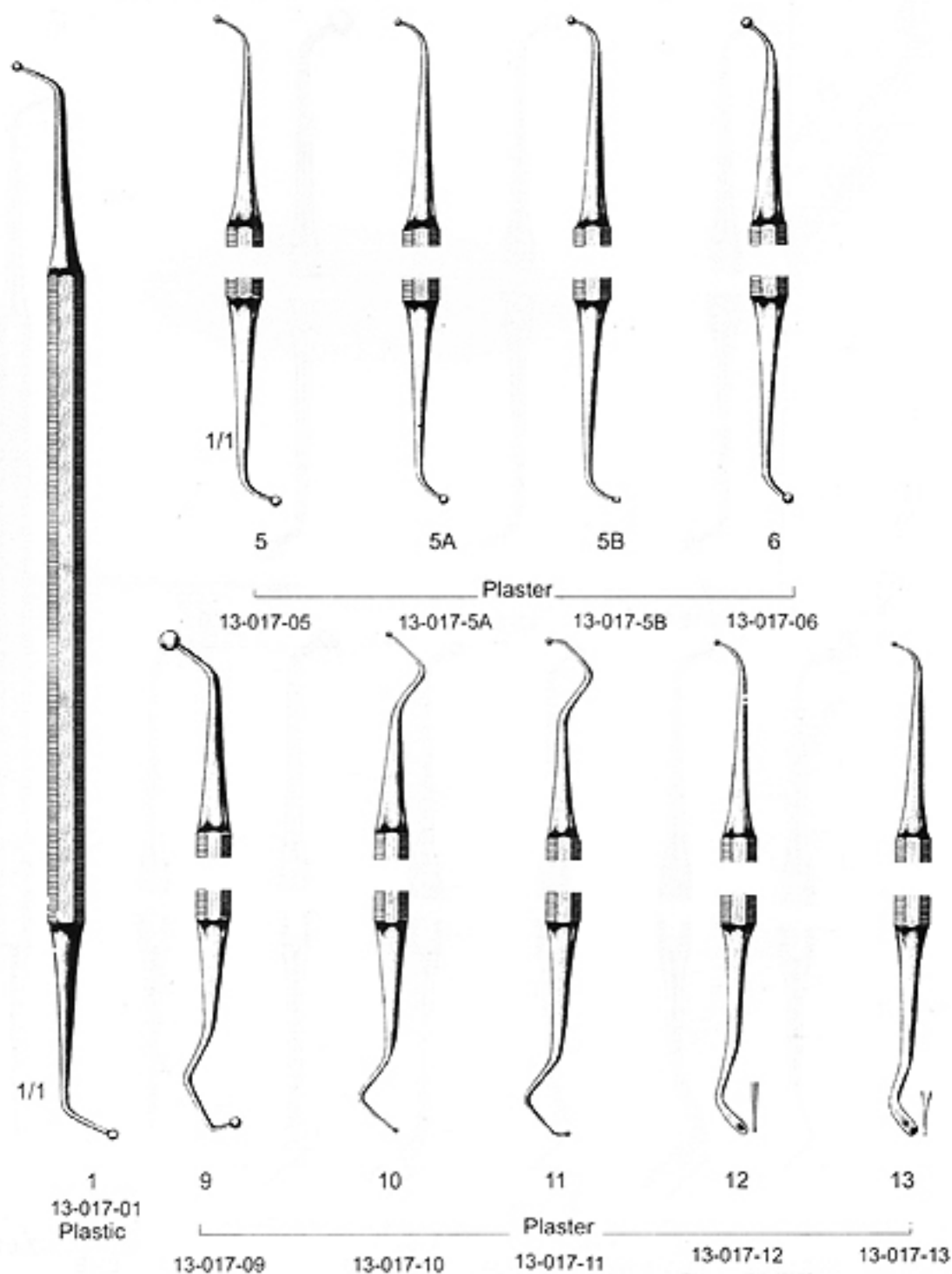

FILLING INSTRUMENTS
INSTRUMENTS POUR PLOMBAGE
INSTRUMENTOS PARA OBTURACIONES

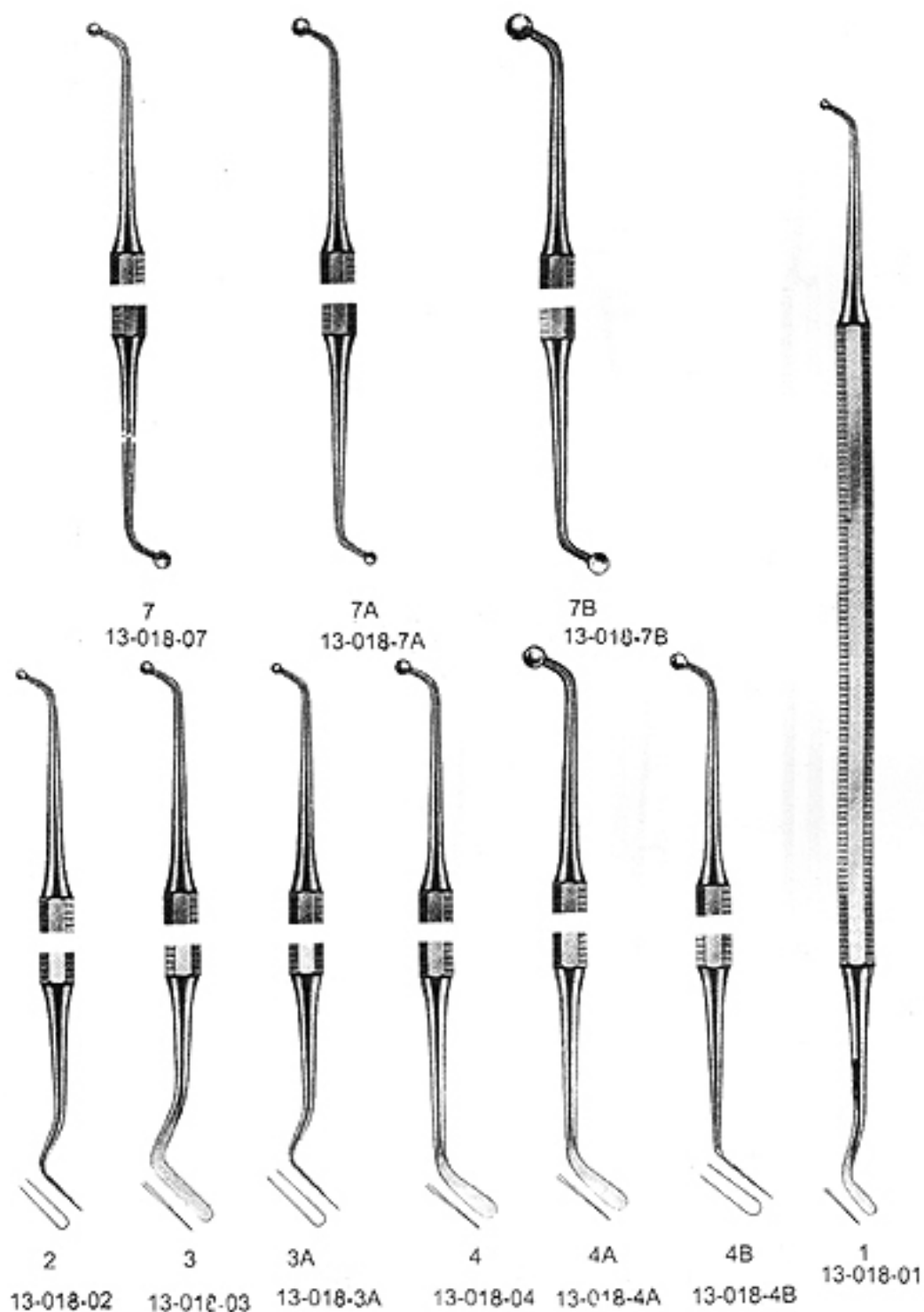

FILLING INSTRUMENTS
INSTRUMENTS POUR PLOMBAGE
INSTRUMENTOS PARA OBTURACIONES

13



7
13-018-07
Plastic

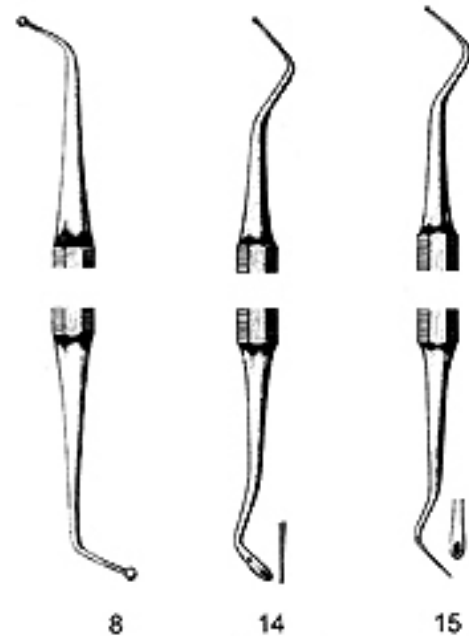

Plastic

13-018-08 13-018-14 13-018-15

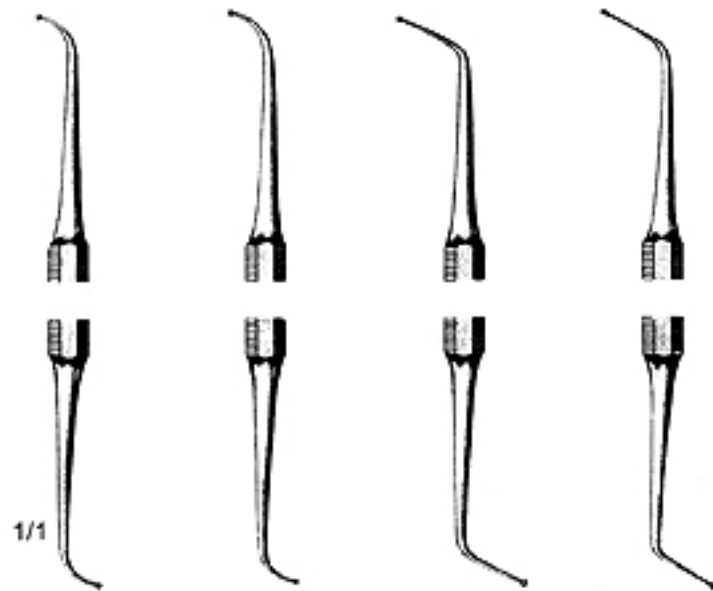

1/1

16 17 18 19
Plastic
13-018-16 13-018-17 13-018-18 13-018-19

FILLING INSTRUMENTS
 INSTRUMENTS POUR PLOMBAGE
 INSTRUMENTOS PARA OBTURACIONES



15

13-019-15



16

13-019-16



17

13-019-17



18

13-019-18



19

13-019-19



8

13-019-08



9

13-019-09



10

13-019-10



11

13-019-11



12

13-019-12



13

13-019-13

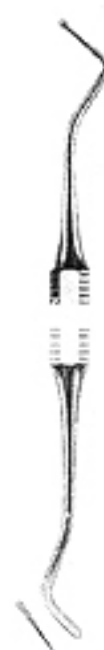

14

13-019-14



FILLING INSTRUMENTS
 INSTRUMENTS POUR PLOMBAGE
 INSTRUMENTOS PARA OBTURACIONES

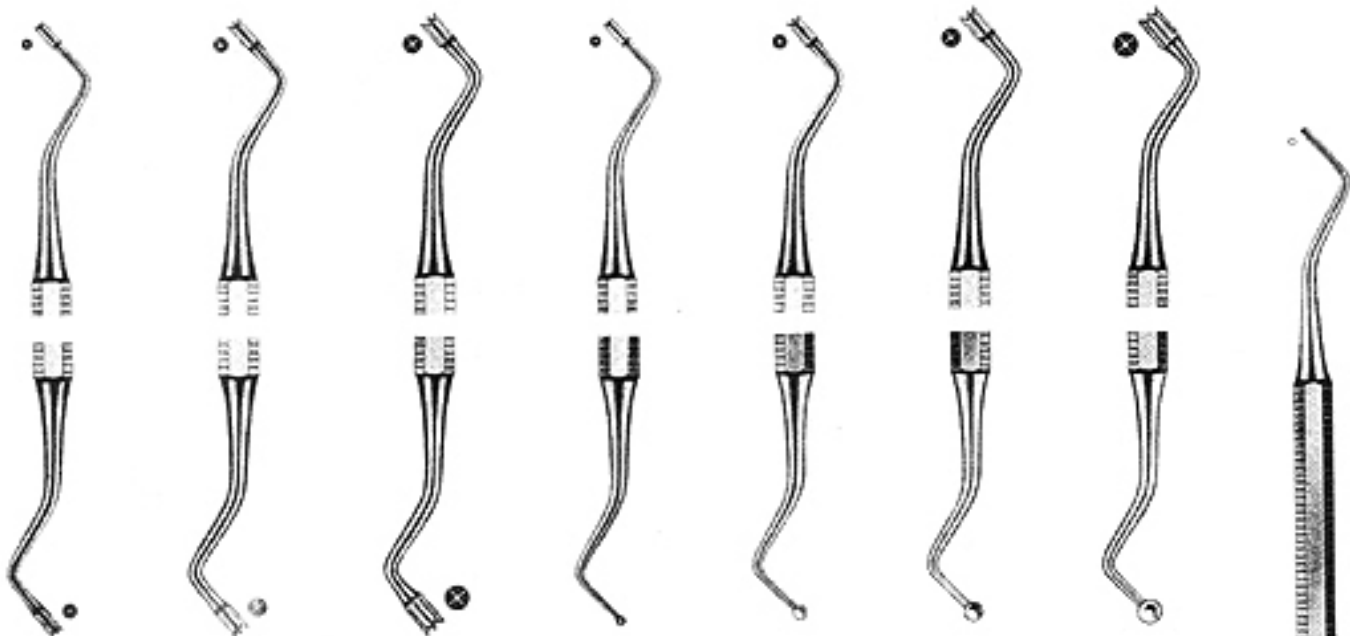

44 13-020-44 45 13-020-45 46 13-020-46 47 13-020-47 48 13-020-48 49 13-020-49 50 13-020-50

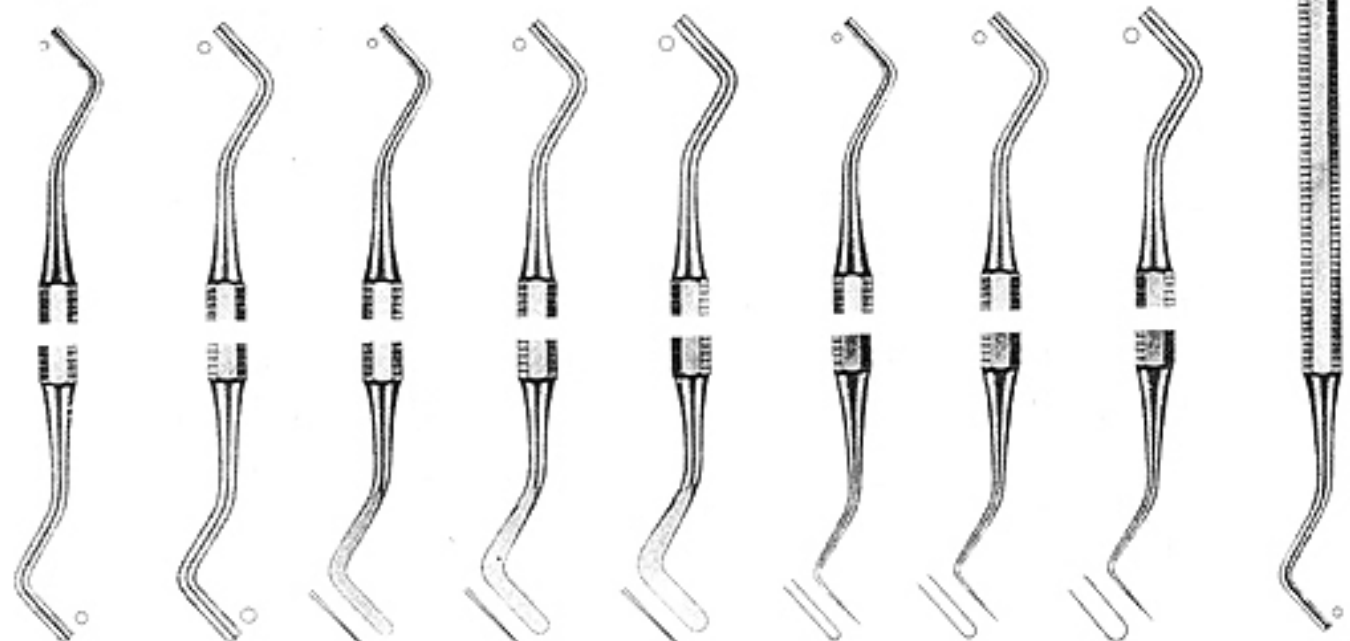

36 13-020-36 37 13-020-37 38 13-020-38 39 13-020-39 40 13-020-40 41 13-020-41 42 13-020-42 43 13-020-43 35 13-020-35

FILLING INSTRUMENTS
INSTRUMENTS POUR PLOMBAGE
INSTRUMENTOS PARA OBTURACIONES

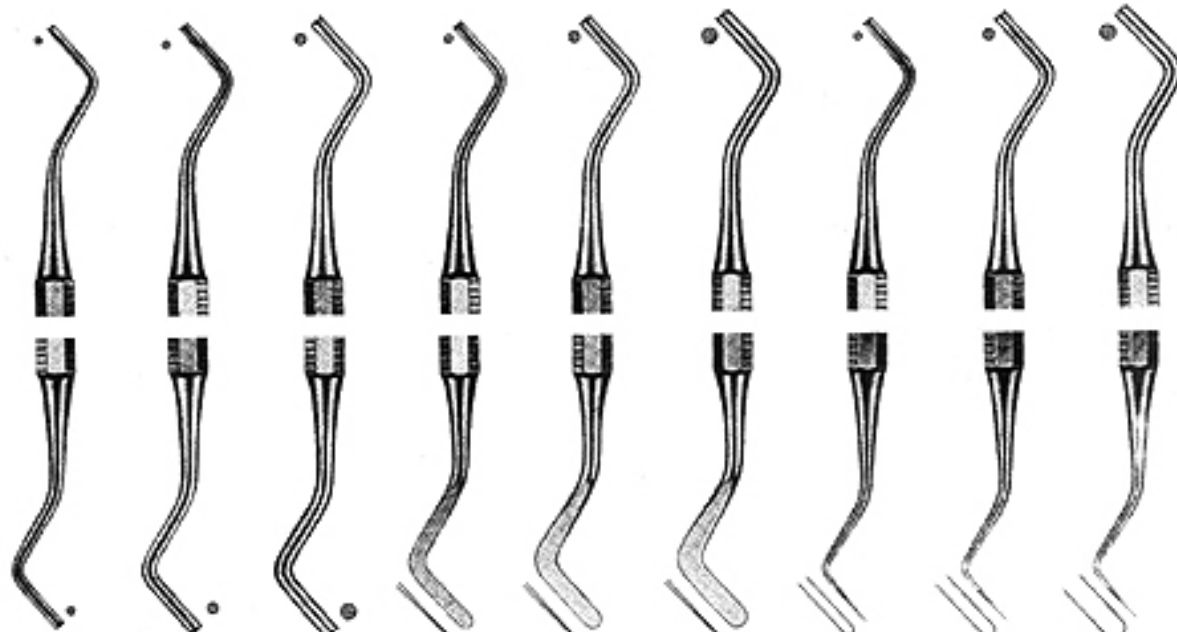
26

27

28

29

30

31

32

33

34

13-021-26

13-021-27

13-021-28

13-021-29

13-021-30

13-021-31

13-021-32

13-021-33

13-021-34

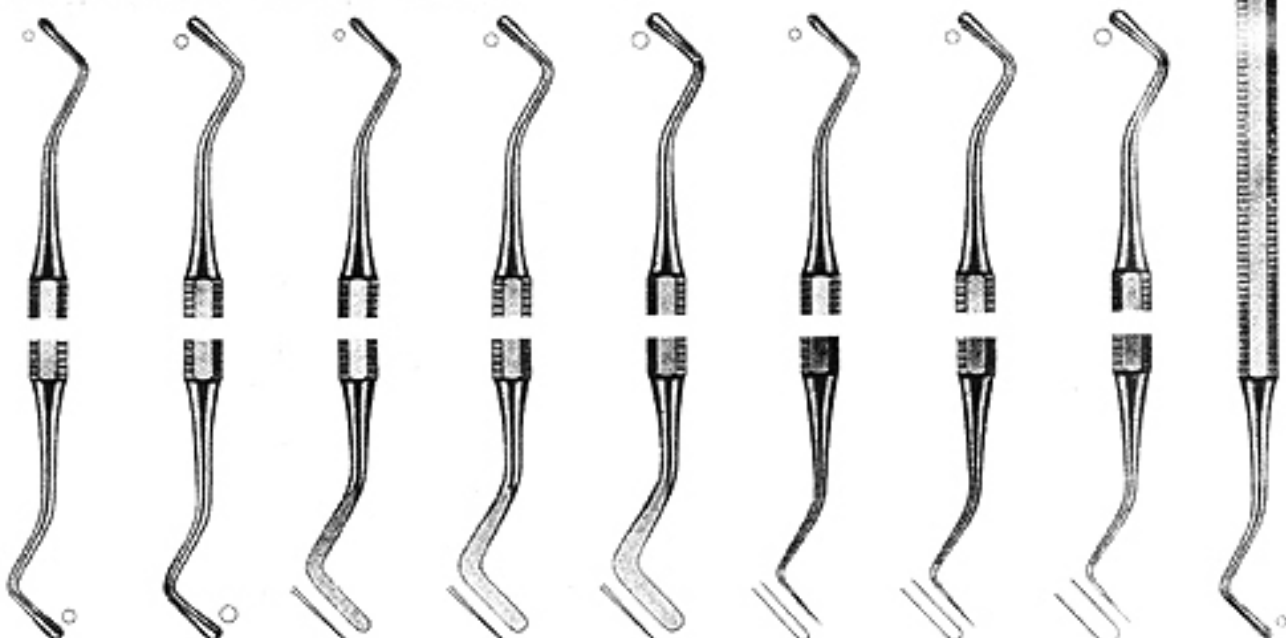

18

19

20

21

22

23

24

25

17

13-021-18

13-021-19

13-021-20

13-021-21

13-021-22

13-021-23

13-021-24

13-021-25

13-021-17



FILLING INSTRUMENTS
INSTRUMENTS POUR PLOMBAGE
INSTRUMENTOS PARA OBTURACIONES

13

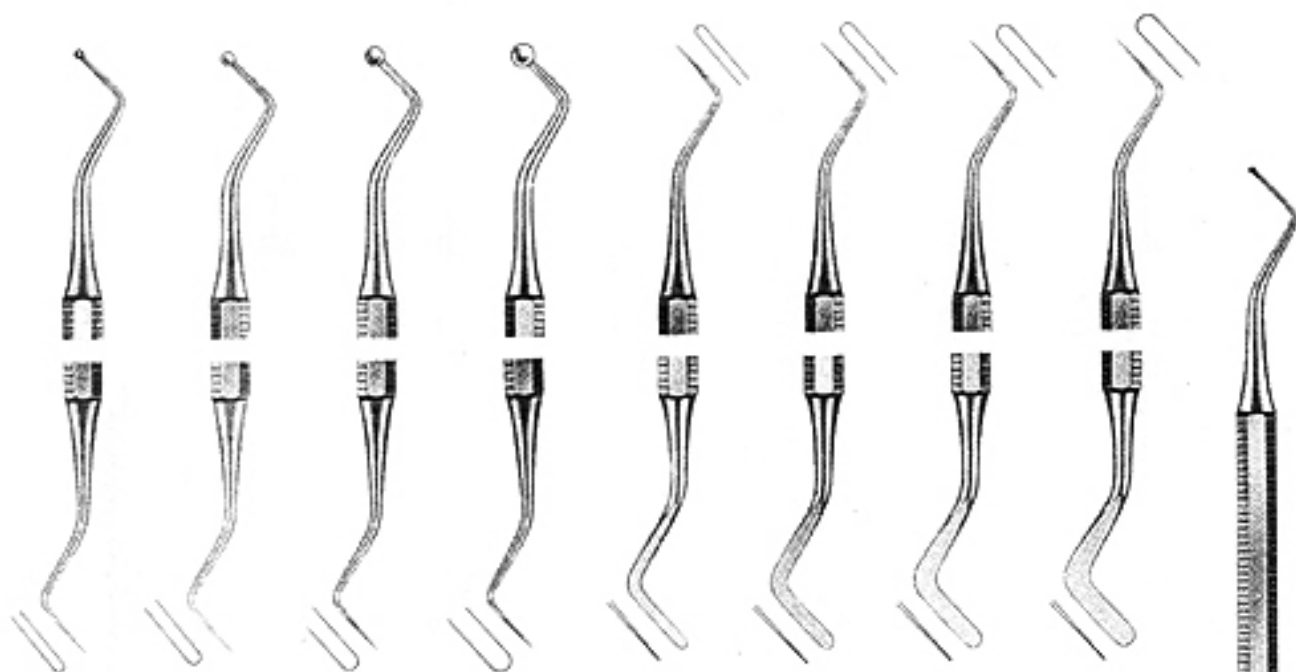

9 10 11 12 13 14 15 16
13-022-09 13-022-10 13-022-11 13-022-12 13-022-13 13-022-14 13-022-15 13-022-16

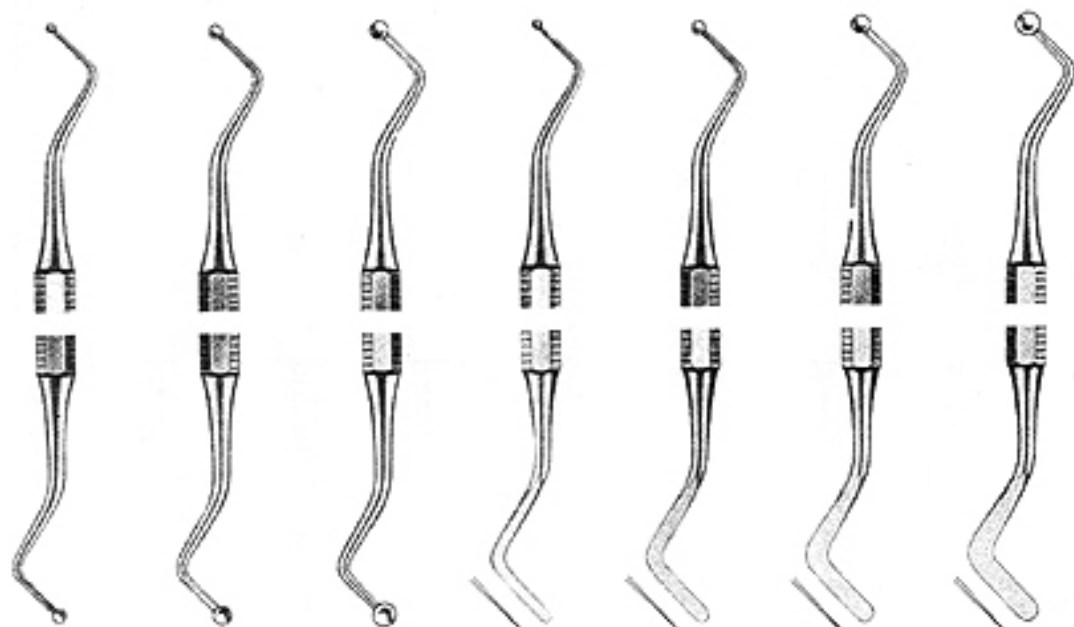

2 3 4 5 6 7 8 1
13-022-02 13-022-03 13-022-04 13-022-05 13-022-06 13-022-07 13-022-08 13-022-01

FILLING INSTRUMENTS
INSTRUMENTS POUR PLOMBAGE
INSTRUMENTOS PARA OBTURACIONES

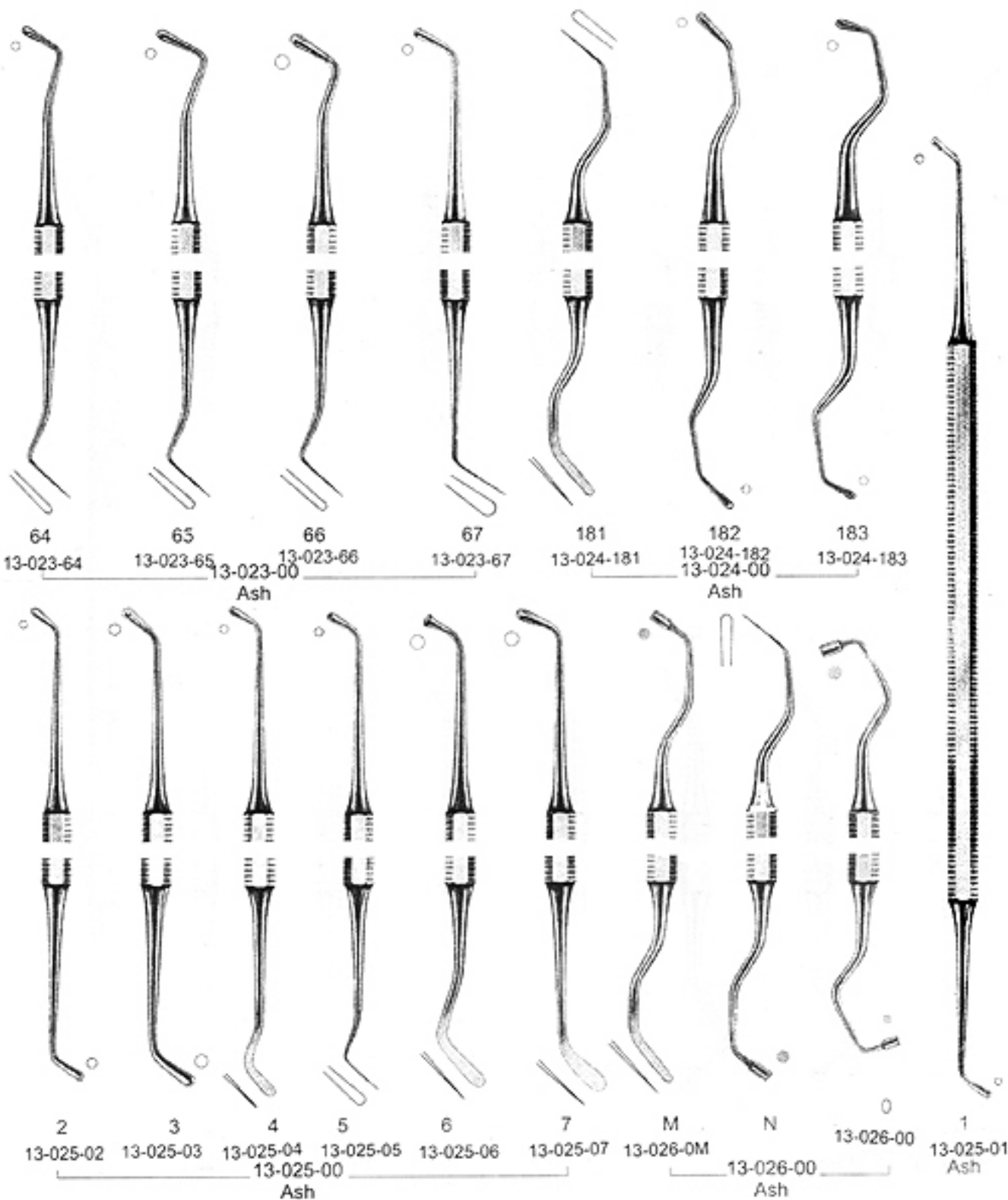

FILLING INSTRUMENTS
 INSTRUMENTS POUR PLOMBAGE
 INSTRUMENTOS PARA OBTURACIONES

13

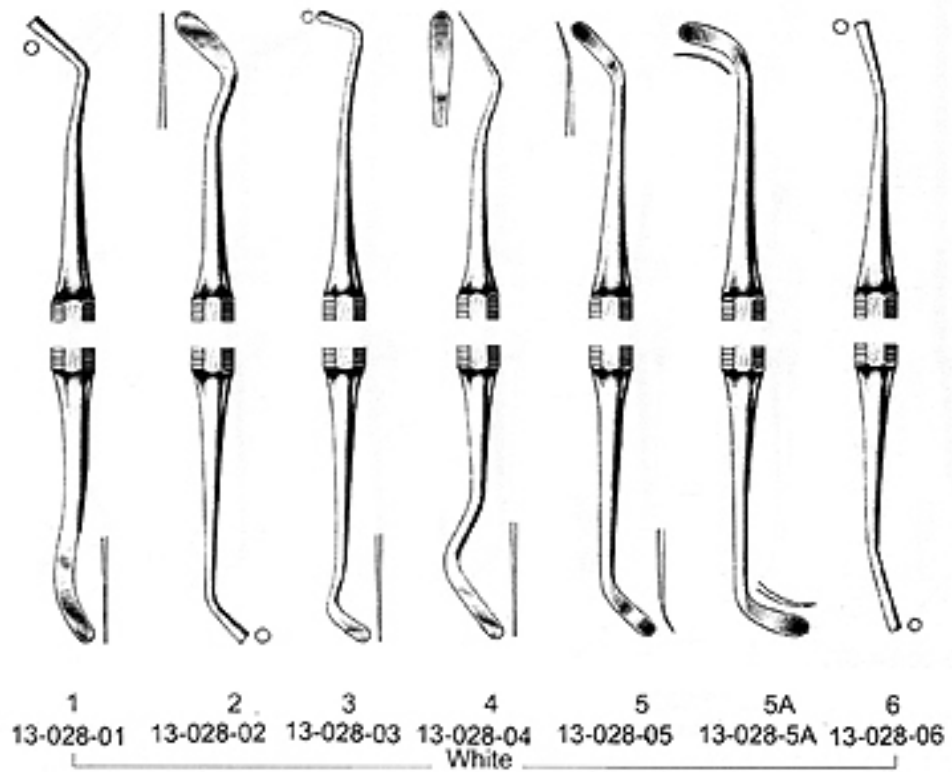
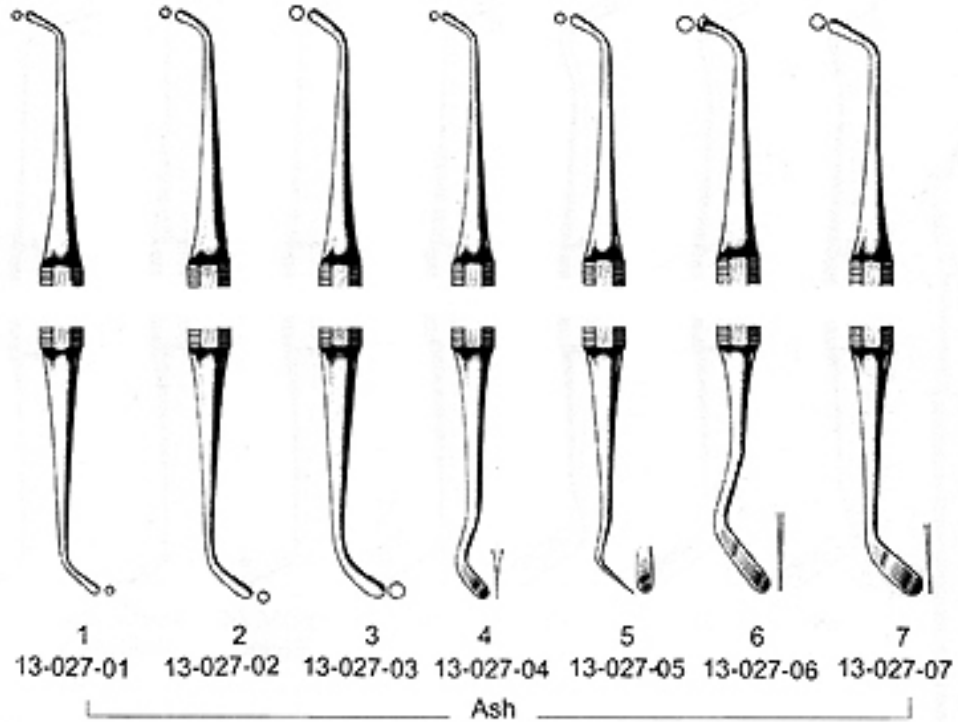

13-027-00
 13-028-00

FILLING INSTRUMENTS
INSTRUMENTS POUR PLOMBAGE
INSTRUMENTOS PARA OBTURACIONES

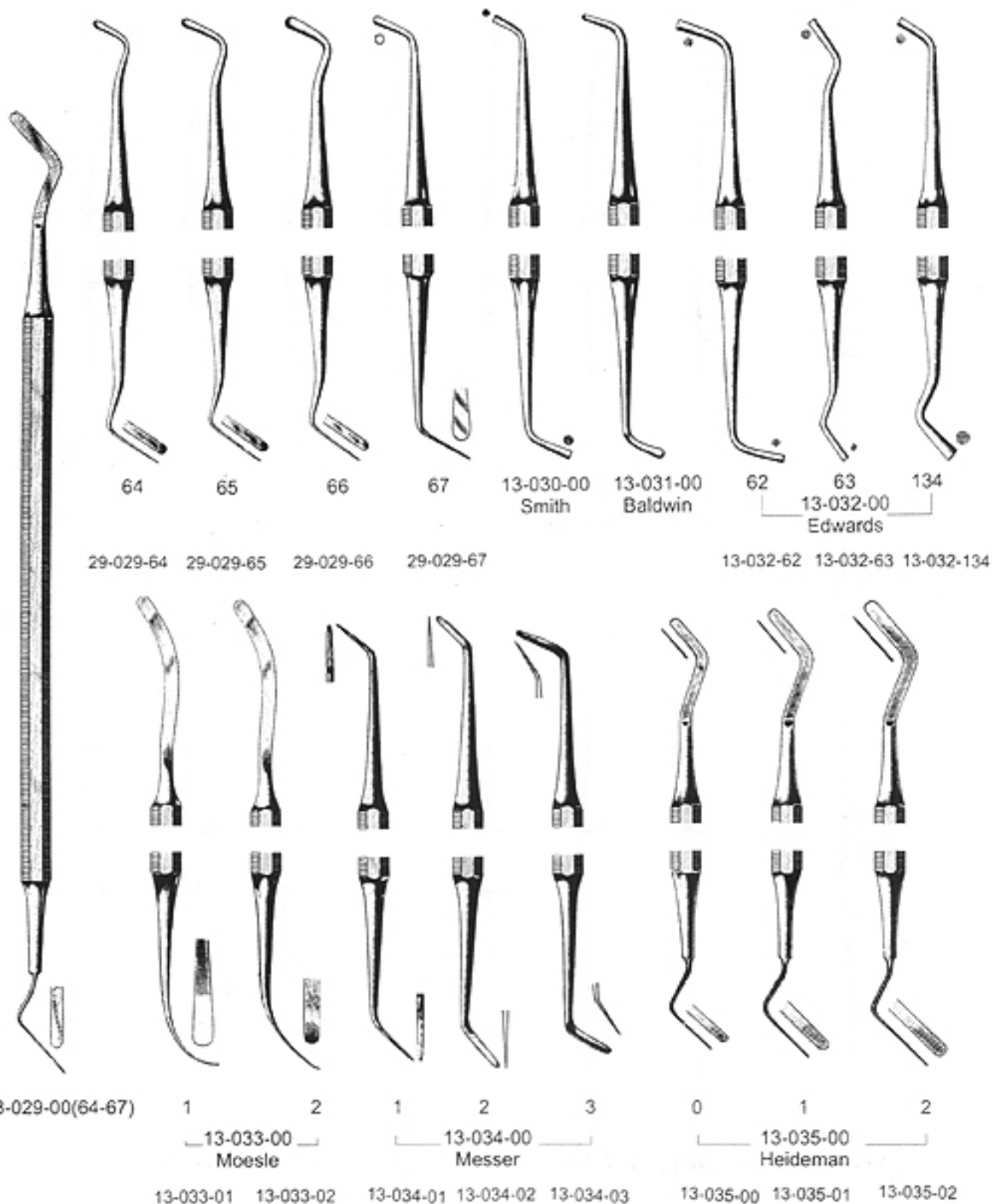

FILLING INSTRUMENTS
INSTRUMENTS POUR PLOMBAGE
INSTRUMENTOS PARA OBTURACIONES

13



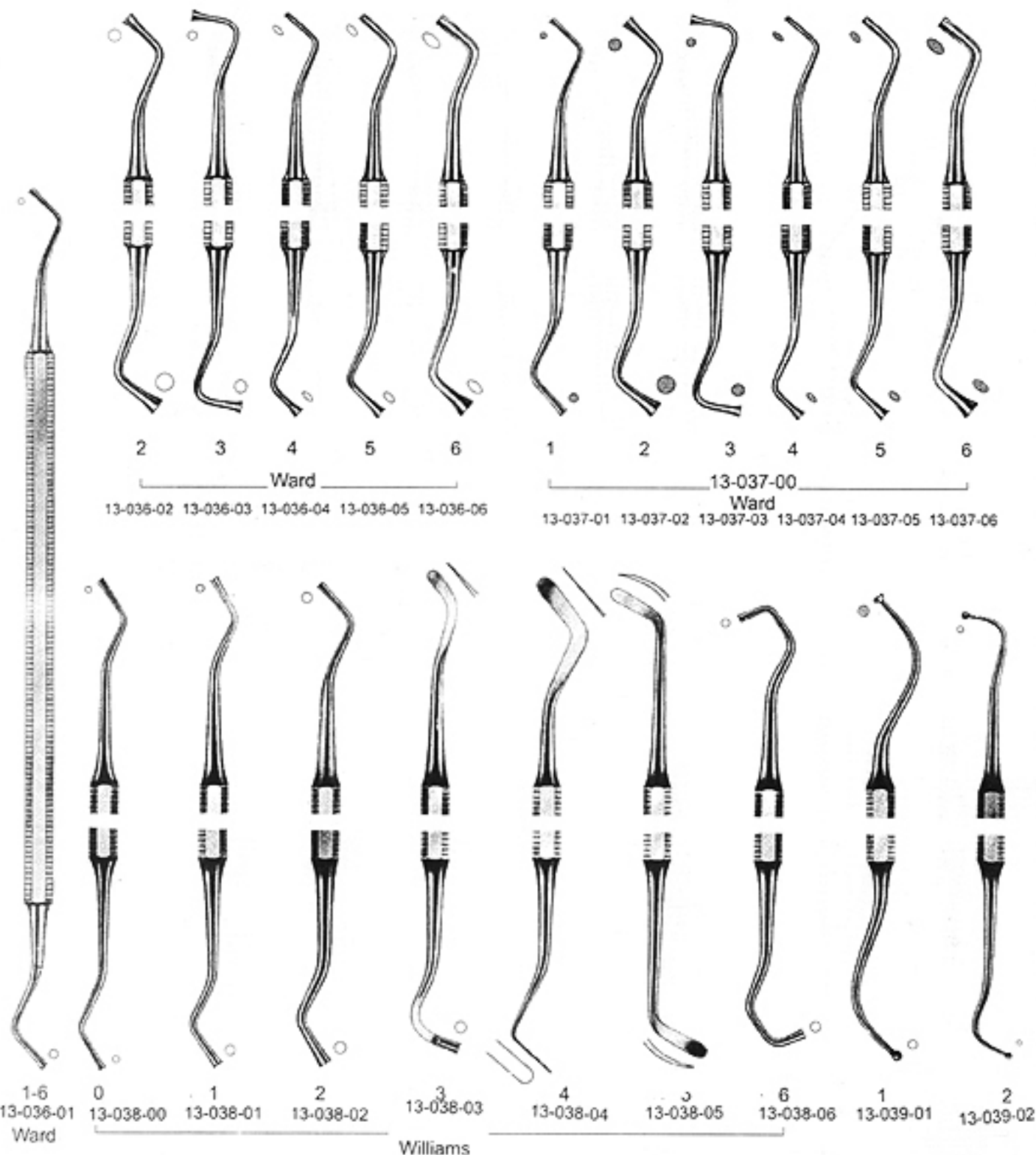

ARAIN

FILLING INSTRUMENTS
INSTRUMENTS POUR PLOMBAGE
INSTRUMENTOS PARA OBTURACIONES

13

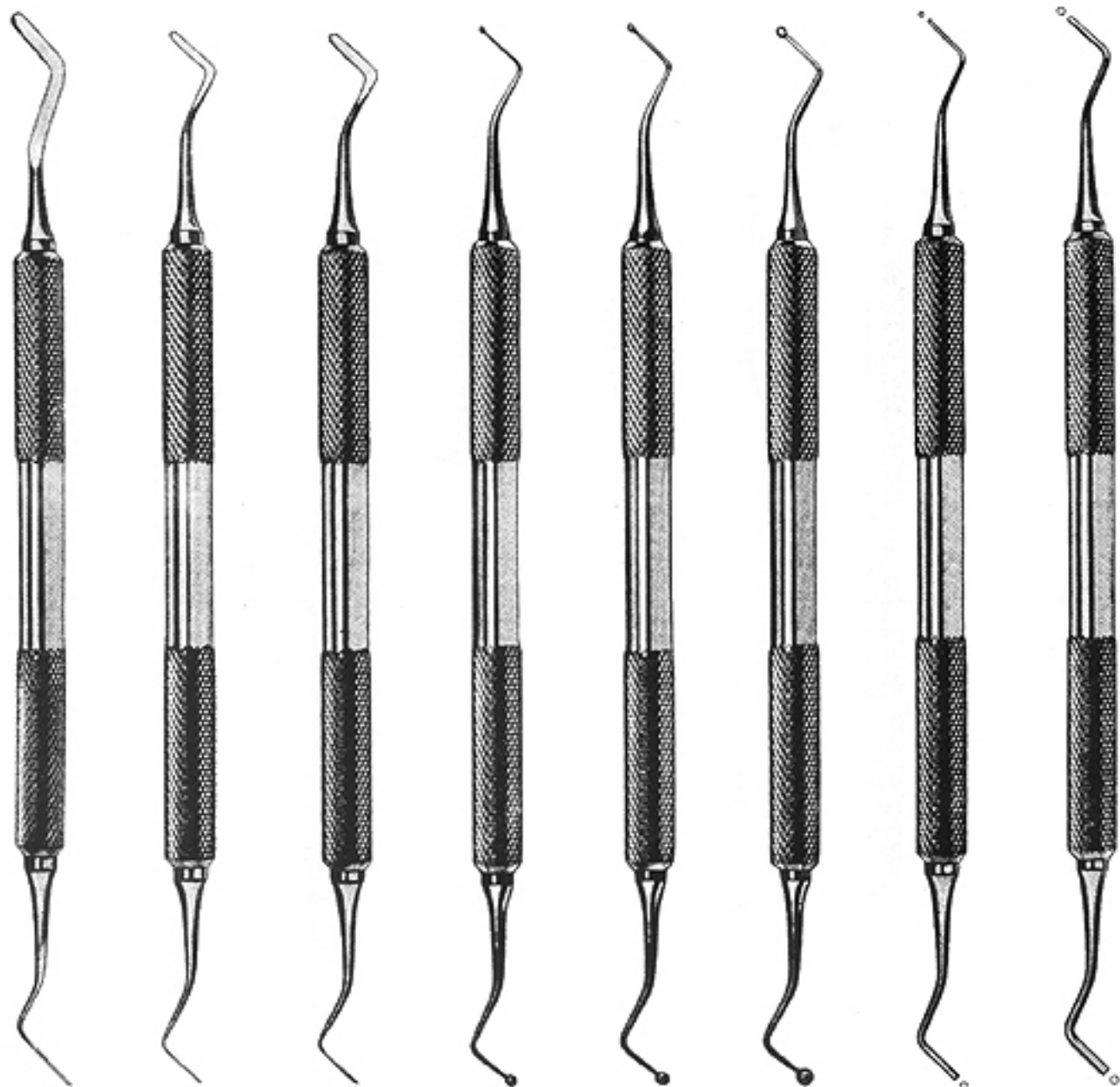

42
13-048-00
Hidemann

11
13-049-00

12
13-050-00

2
13-051-00

4
13-052-00

6
13-053-00

20
13-054-00

21
13-055-00

FILLING INSTRUMENTS
 INSTRUMENTS POUR PLOMBAGE
 INSTRUMENTOS PARA OBTURACIONES

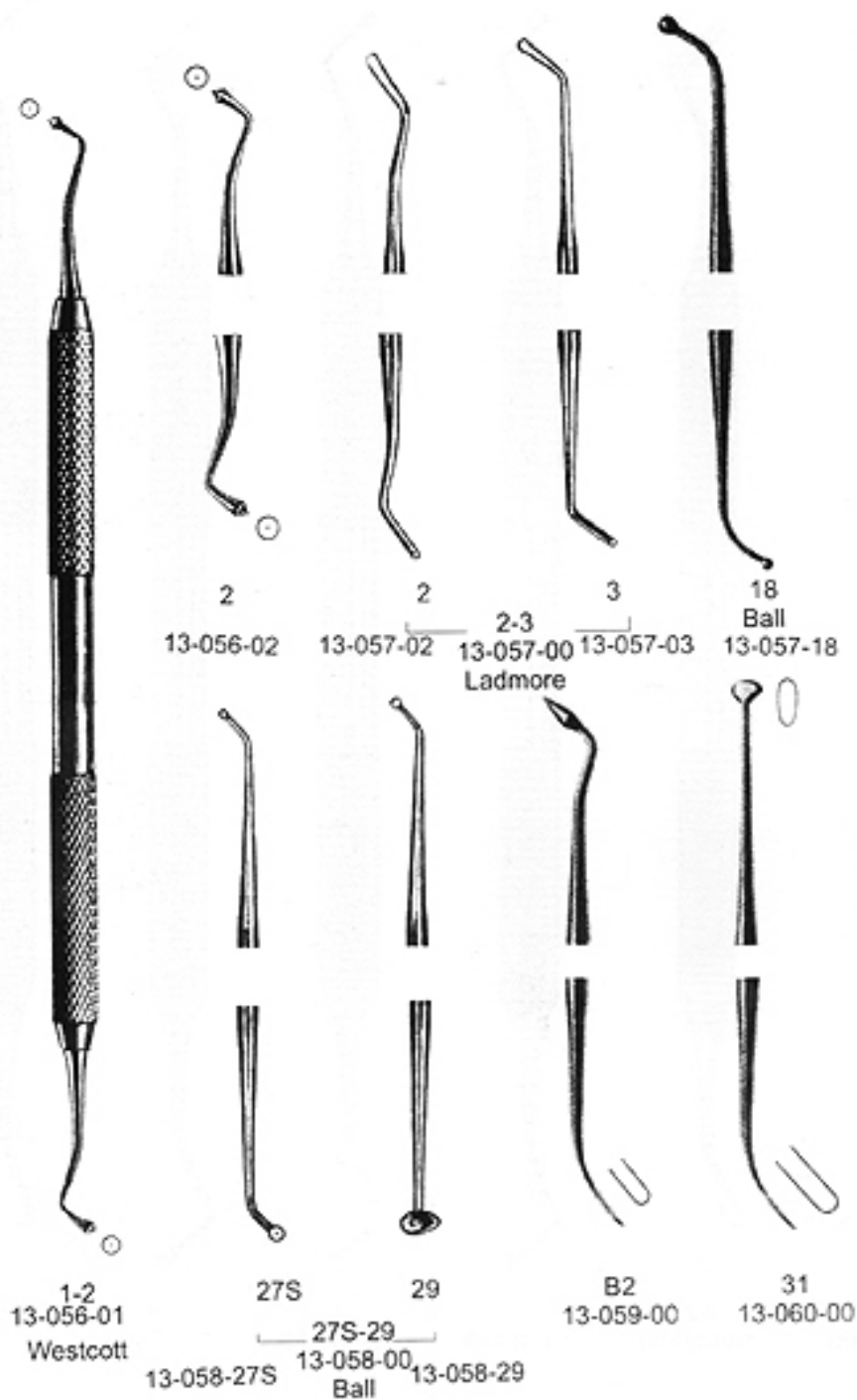





ARAIN

FILLING INSTRUMENTS
INSTRUMENTS POUR PLOMBAGE
INSTRUMENTOS PARA OBTURACIONES

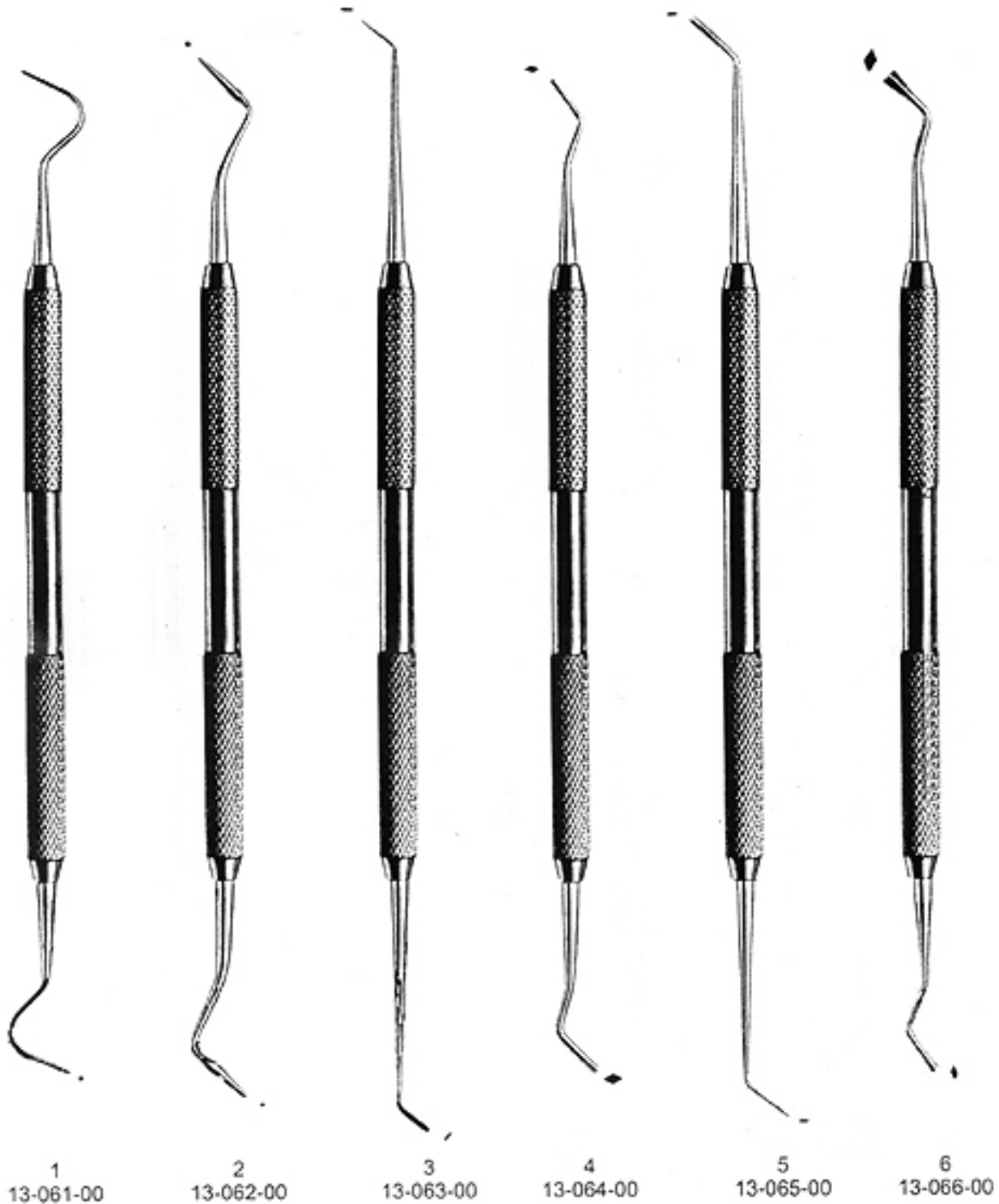
13



M. A. ARAIN & BROTHERS (PVT.) LTD.

201

FILLING INSTRUMENTS
INSTRUMENTS POUR PLOMBAGE
INSTRUMENTOS PARA OBTURACIONES

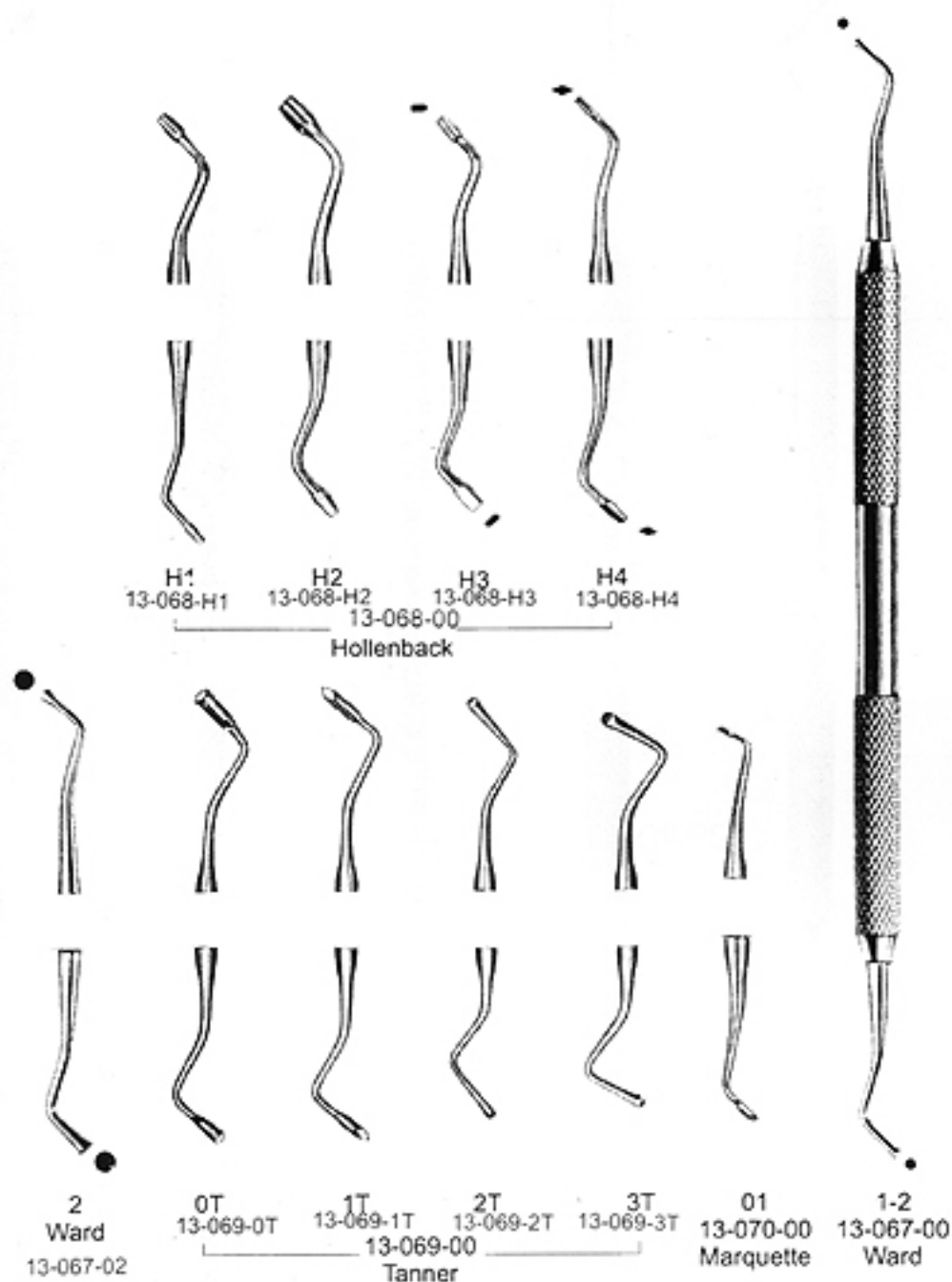





ARAIN

FILLING INSTRUMENTS
INSTRUMENTS POUR PLOMBAGE
INSTRUMENTOS PARA OBTURACIONES

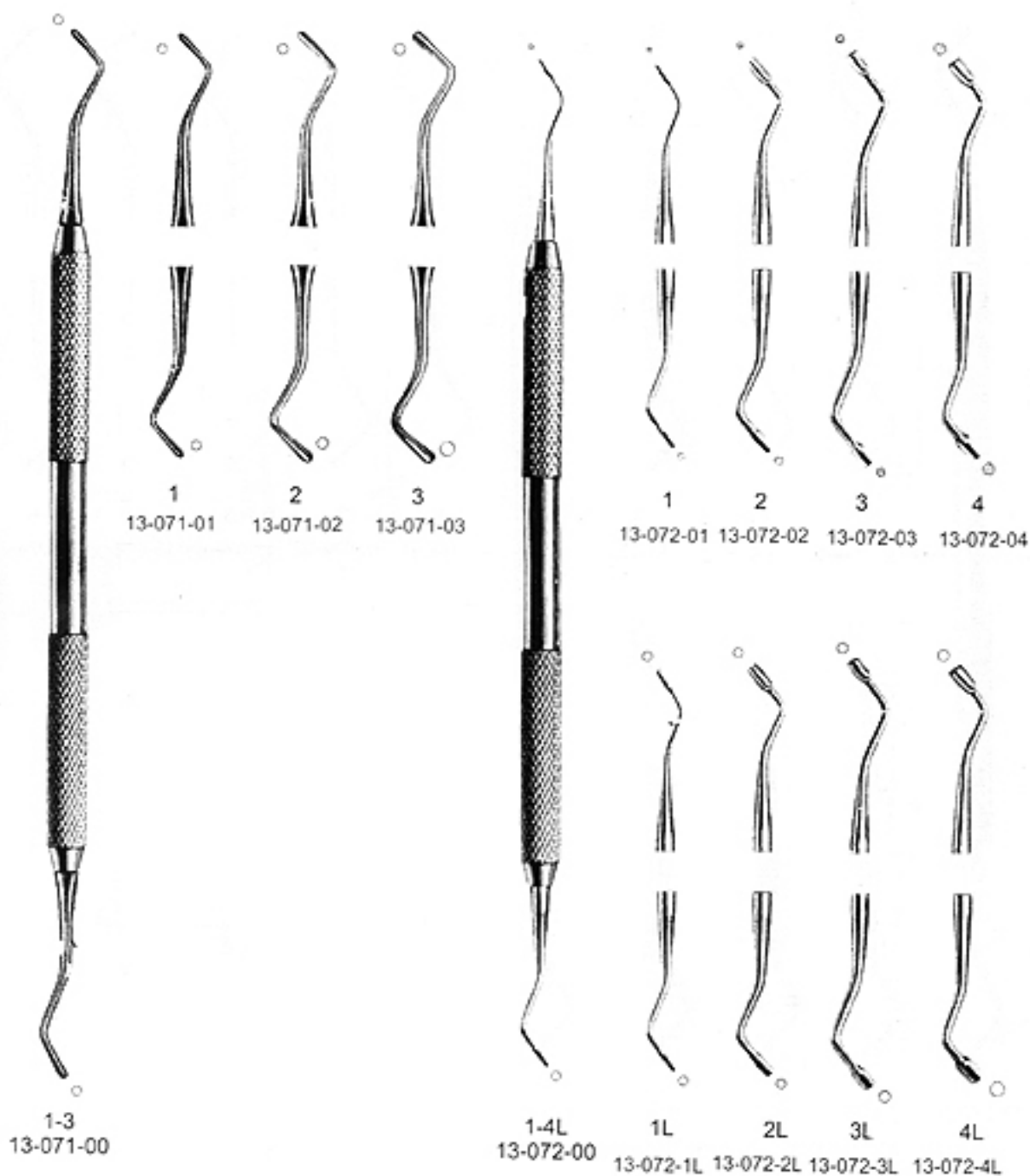
13



FILLING INSTRUMENTS
 INSTRUMENTS POUR PLOMBAGE
 INSTRUMENTOS PARA OBTURACIONES

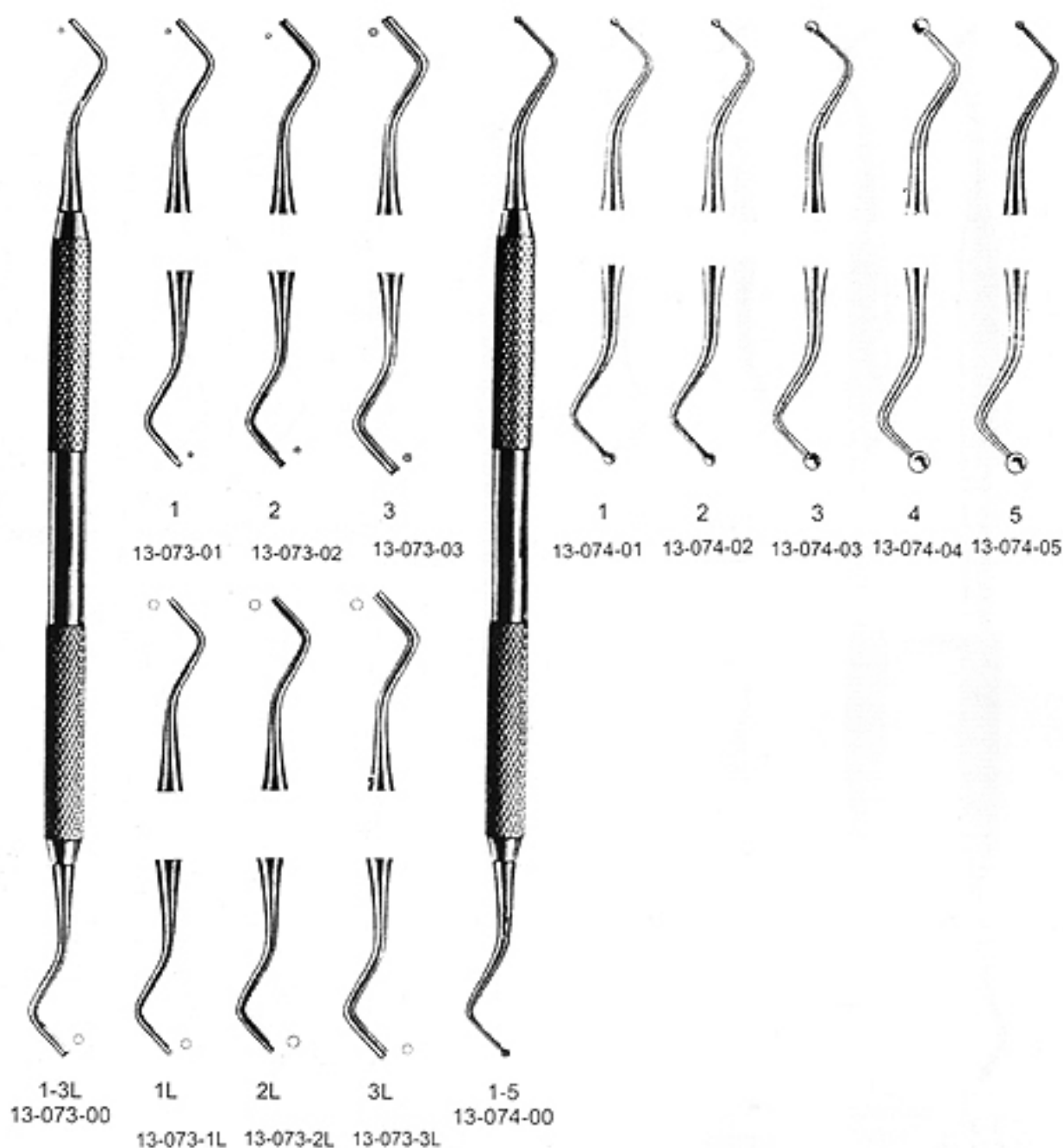

FILLING INSTRUMENTS
INSTRUMENTS POUR PLOMBAGE
INSTRUMENTOS PARA OBTURACIONES

13

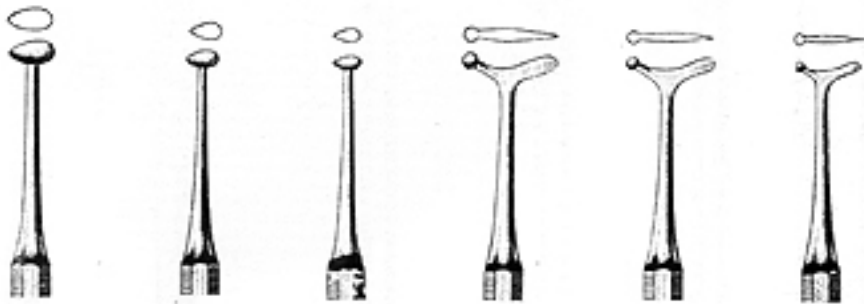

28 29 31 32 33 34
White
13-076-28 13-076-29 13-076-31 13-076-32 13-076-33 13-076-34



1 2 3 5 25 26 27
1-34
White
13-076-01 13-076-02 13-076-03 13-076-05 13-076-25 13-076-26 13-076-27
1 1
13-075-00 13-077-00 13-078-00

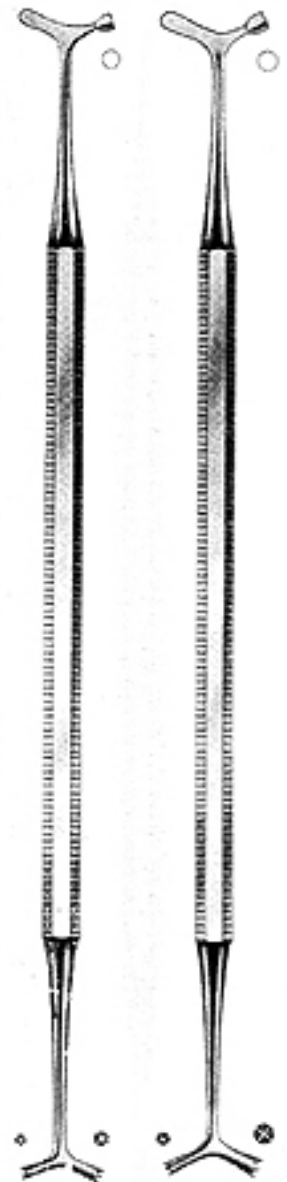

FILLING INSTRUMENTS
INSTRUMENTS POUR PLOMBAGE
INSTRUMENTOS PARA OBTURACIONES



ARAIN



1
13-079-01



28/29
13-079-00



27/29
13-080-00



21B
13-081-00



21
13-082-00



Discoide
89/92
13-083-00



13-084-00



FILLING INSTRUMENTS
INSTRUMENTS POUR PLOMBAGE
INSTRUMENTOS PARA OBTURACIONES

13

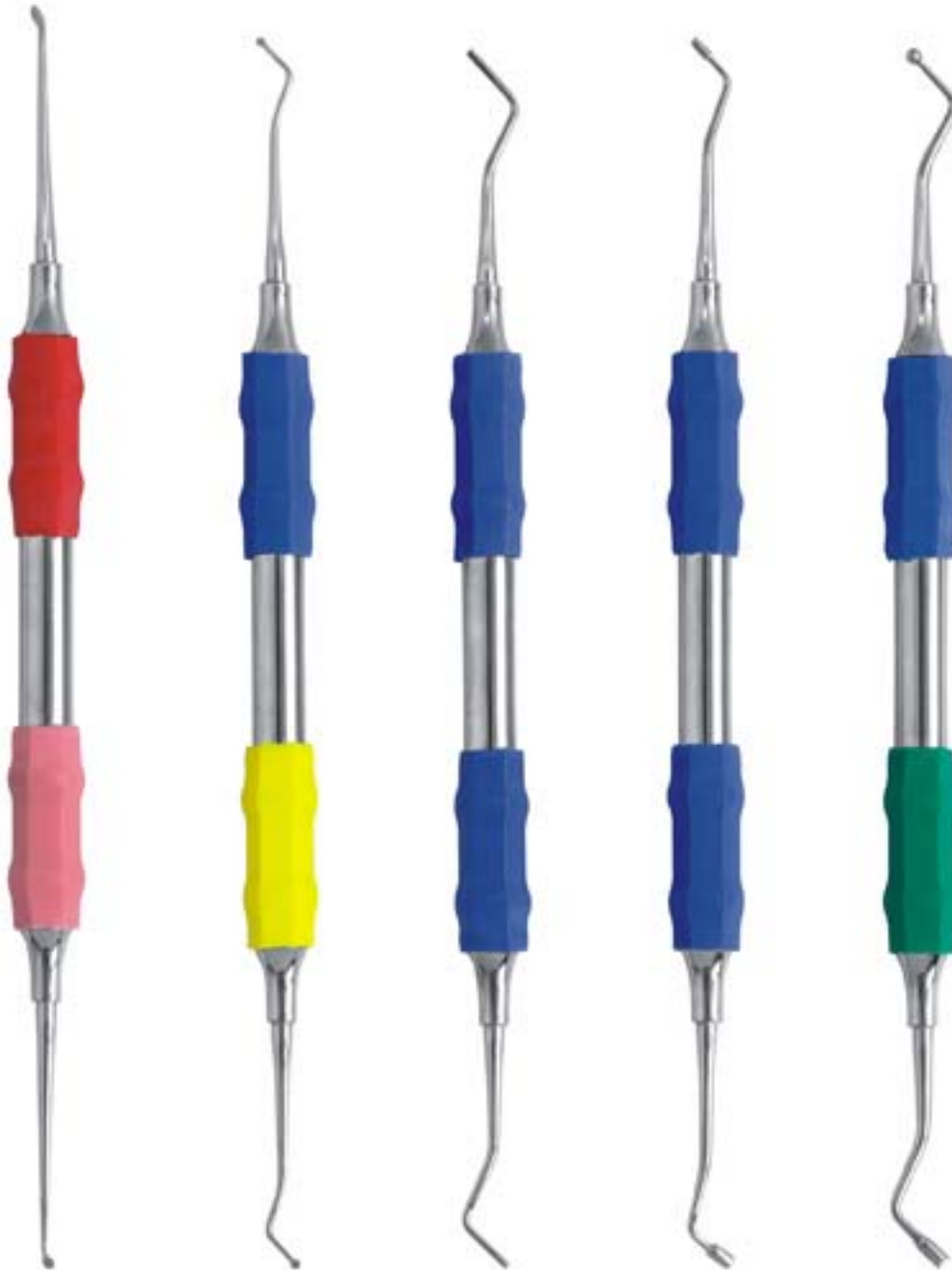

Cleoid-Discoid
89/90
13-099-00

Excavator
17
13-100-00

Filling
Instrument
13-101-00

Filling
Instrument
13-102-00

Amalgam
Condenser
13-103-00

NOTE: All other hand instruments are also available in Silicon Grip Handle

Department

14

BONE RONGEUR FORCEPS
HOHLMEISSELZANGEN
PINZAS GUBIAS

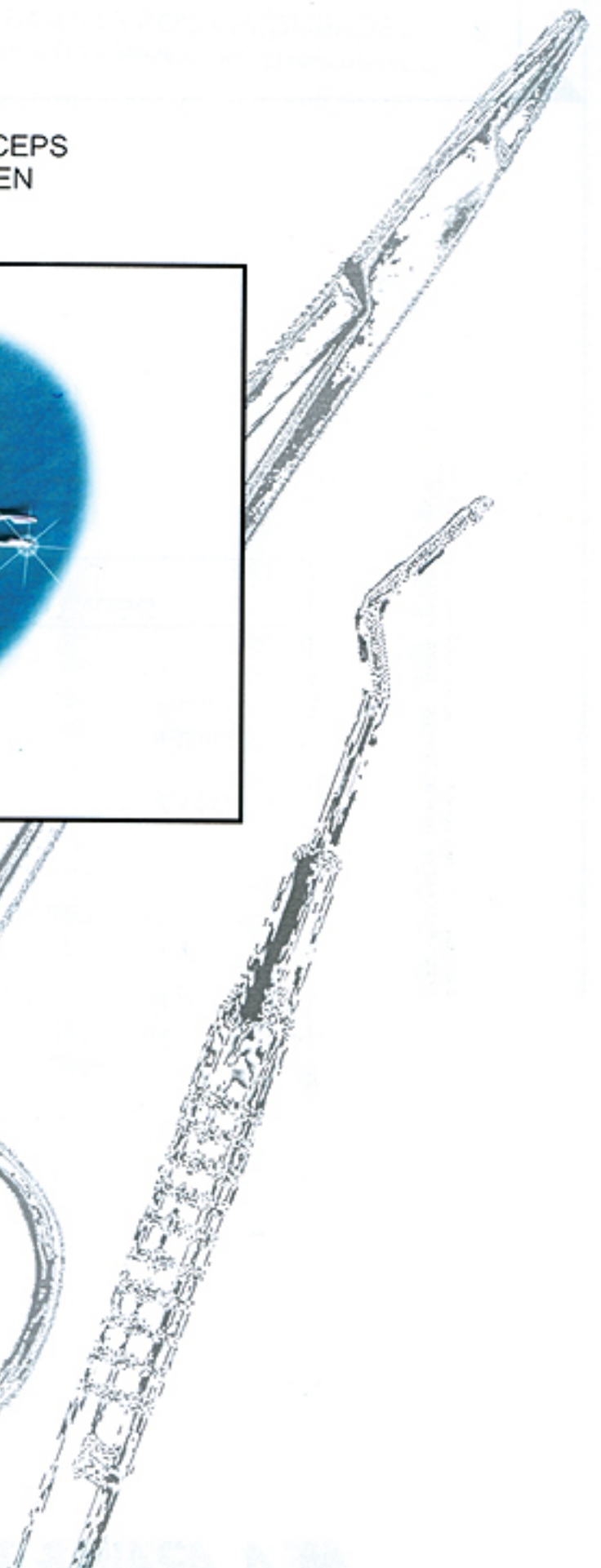
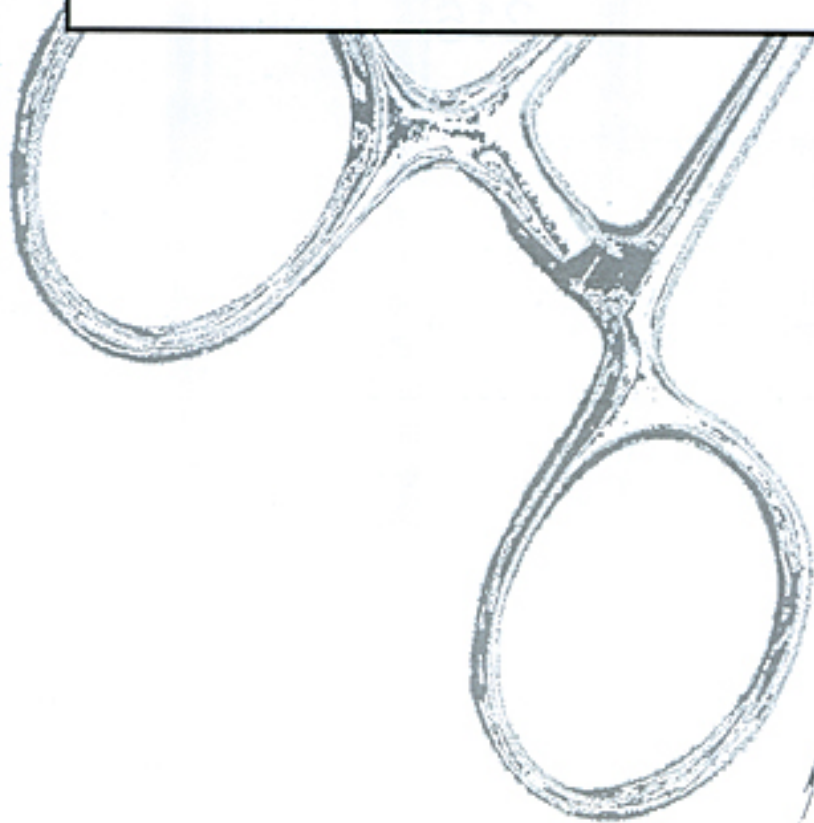
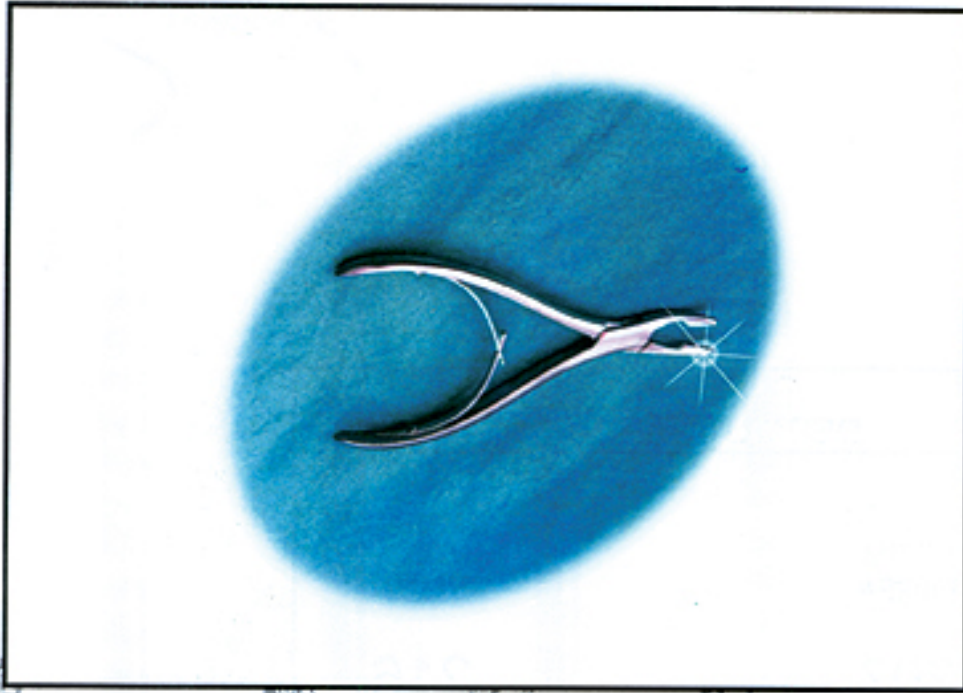

DEPARTMENT NO. 14

FROM
PAGE#

207

TO
PAGE#

216

INSTRUMENTS CATEGORY

BONE RONGEUR FORCEPS
HOHLMEISSELZANGEN
PINZAS GUBIAS



BONE RONGEUR FORCEPS
HOHLMEISSELZANGEN
PINZAS GUBIAS

14



14-001-17
17. Cm
Cleveland



14-002-14
14. Cm
Friedman



14-003-14
14. Cm
Cleveland



14-004-12
12. Cm
Mini-Friedman



14-005-18
18.5 Cm
Hartmann



14-006-16
16.5 Cm



14-007-16
16.5 Cm

Mead

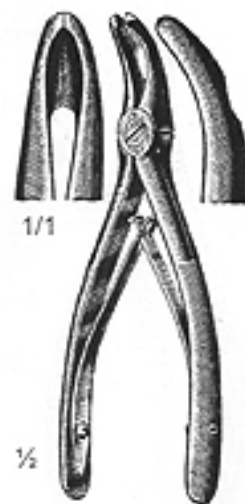

14-008-13
13.5 Cm
Universal

BONE RONGEUR FORCEPS
HOHLMEISSELZANGEN
PINZAS GUBIAS





14-009-15
15. Cm
Luer



$\frac{1}{2}$
14-010-18
18. Cm

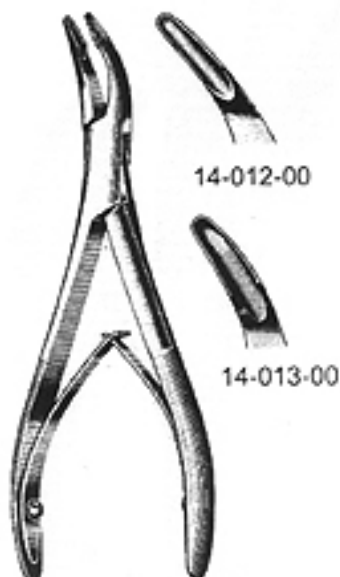

14-011-15
15.5 Cm
Blumenthal



14-012-15
15. Cm
Luer

14-012-00

14-013-00



$\frac{1}{2}$
14-014-15
15.5 Cm

1/1

$\frac{1}{2}$



14-015-15
15.5 Cm

Blumenthal



ARAIN

**BONE RONGEUR FORCEPS
HOHLMEISSELZANGEN
PINZAS GUBIAS**

14



14-016-16
16cm
Cleveland-Gardener



14-016-00



14-017-00



14-018-17
17cm
Cleveland



14-019-15
15cm
Cleveland

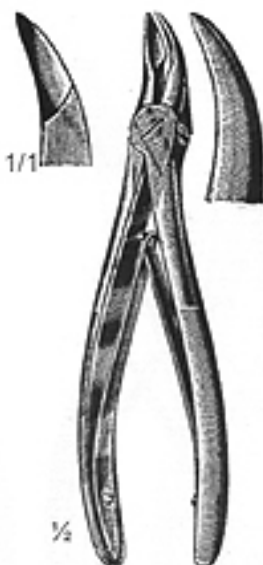

14-020-15
15cm

1/1

1/2



14-021-18
18cm
Beyer

1/1

1/2

BONE RONGEUR FORCEPS
HOHLMEISSELZANGEN
PINZAS GUBIAS

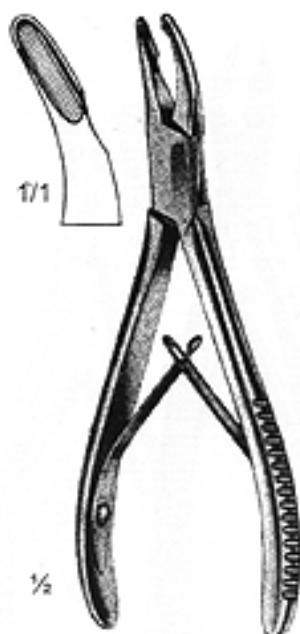
14-072-17
17cm

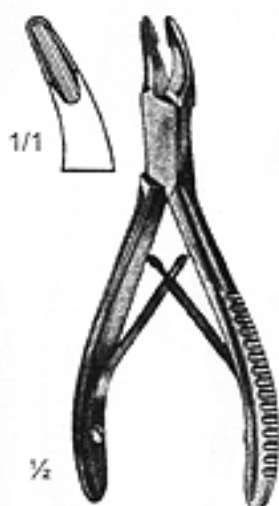

14-073-14
14cm

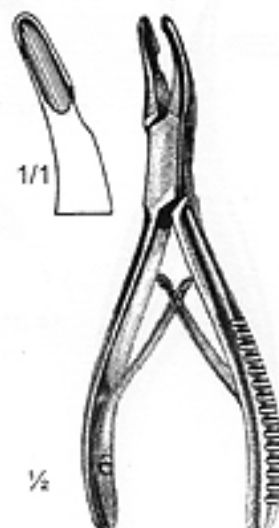

14-074-15
15cm

Cleveland

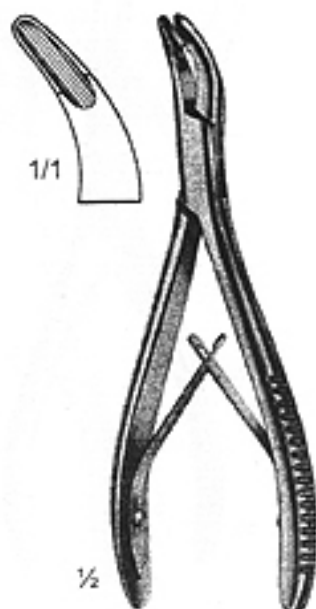

14-075-17
17cm

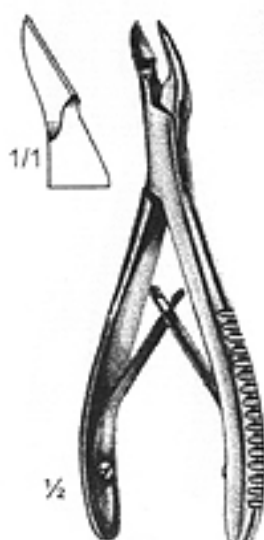

14-076-15
15cm



14-077-17
17cm

Cleveland



ARAIN

**BONE RONGEUR FORCEPS
HOHLMEISSELZANGEN
PINZAS GUBIAS**

14

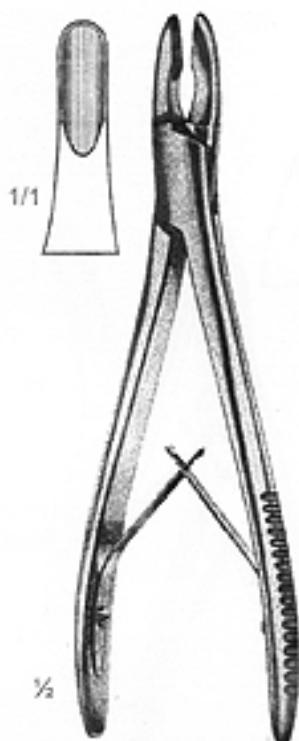

14-078-20
20 cm
Adson

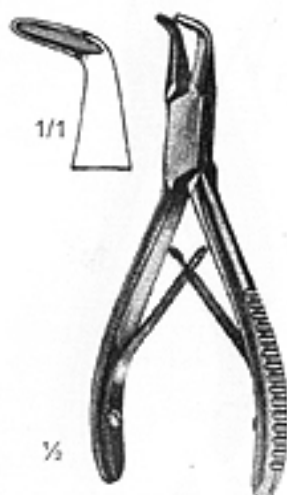

14-079-13
13.5 cm

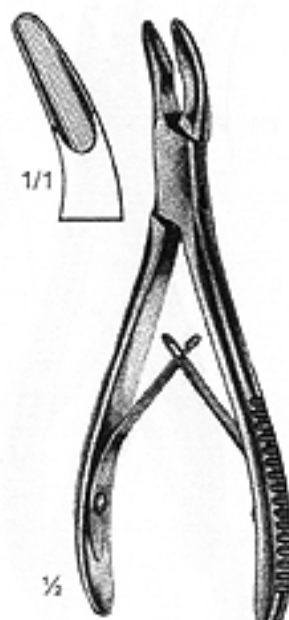

14-080-17
17 cm

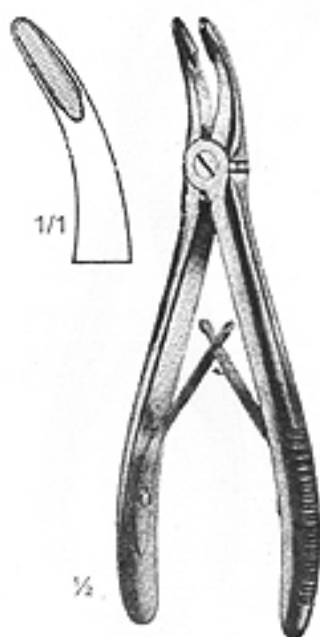

14-081-00



14-082-00

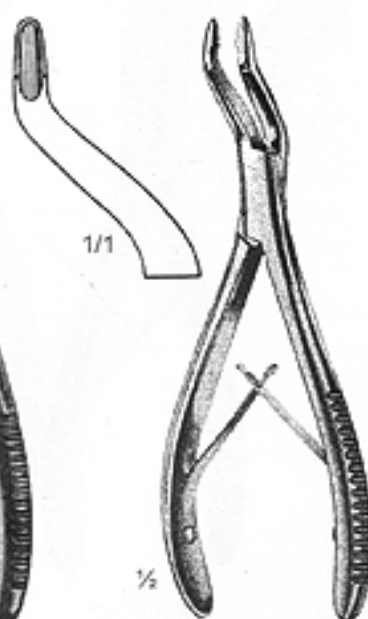

14-063-00

Jansen

BONE RONGEUR FORCEPS
HOHLMEISSELZANGEN
PINZAS GUBIAS

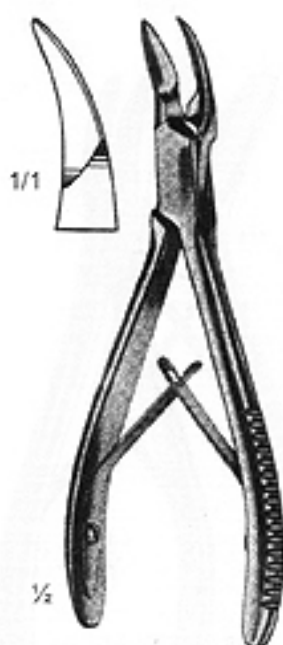
14-084-17
17.5 cm



14-085-14
14 cm

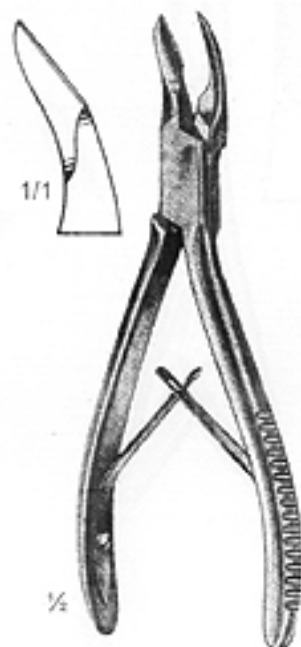

14-086-17
17.5 cm

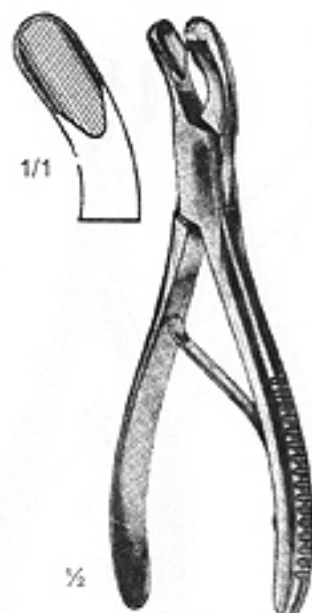

14-087-17
17 cm
Luer



14-088-17
17 cm

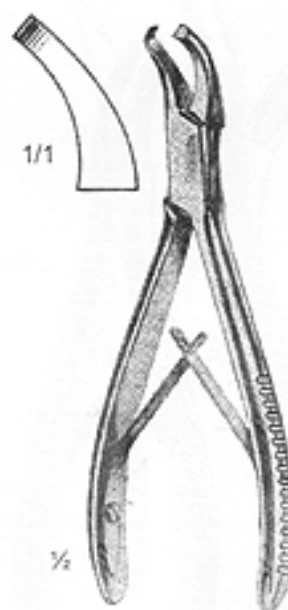

14-089-16
16 cm

Cleveland-Gardner



BONE RONGEUR FORCEPS
HOHLMEISSELZANGEN
PINZAS GUBIAS

14

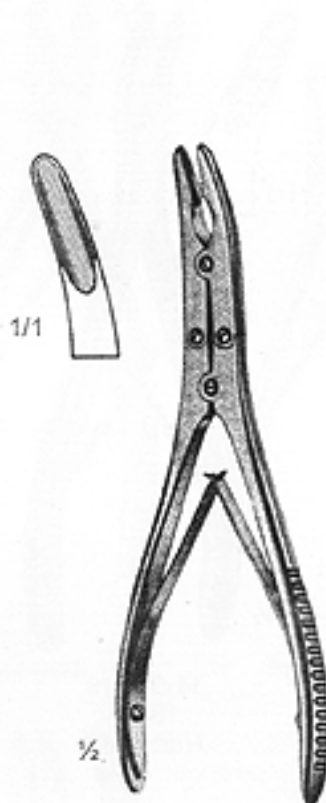

14-090-18
18 cm
Ruskin

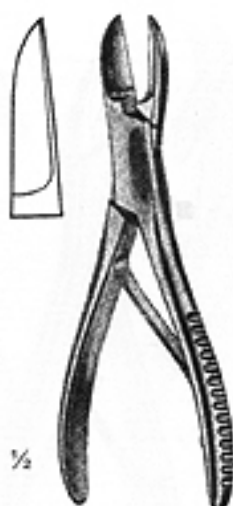

14-091-14
14 cm
Liston

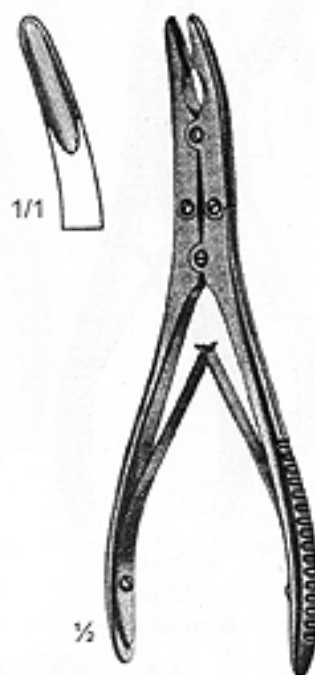

14-092-18
18 cm
Beyer

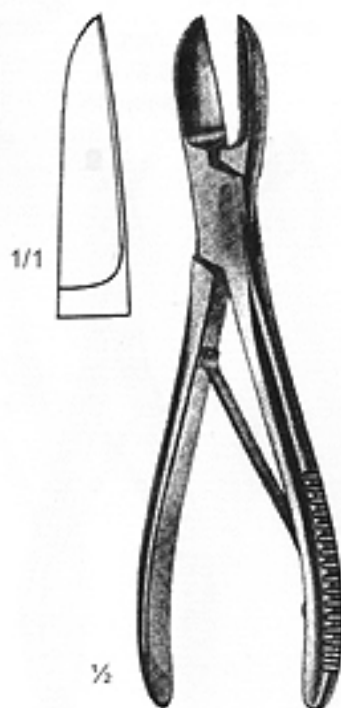

14-093-19
19cm
Liston

BONE RONGEUR FORCEPS
HOHLMEISSELZANGEN
PINZAS GUBIAS

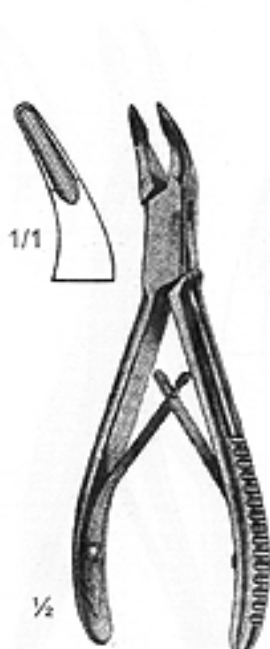
14-094-15
15 cm
Blumenthal-s

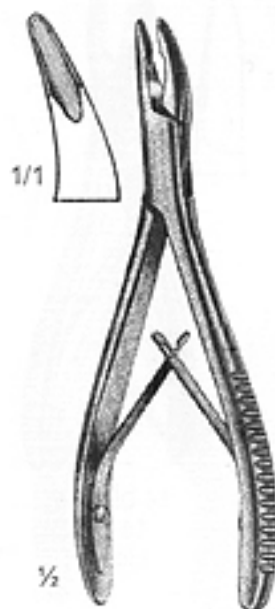

14-095-16
16.5 cm
Blumenthal

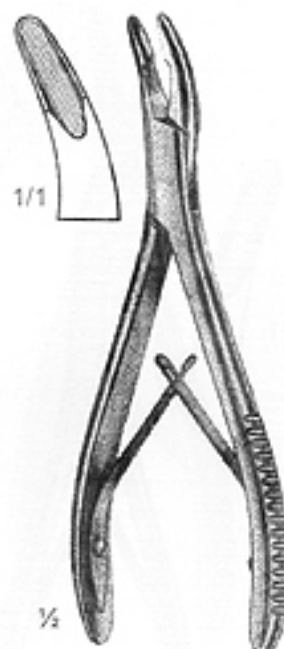

14-096-18
18 cm
Hartmann

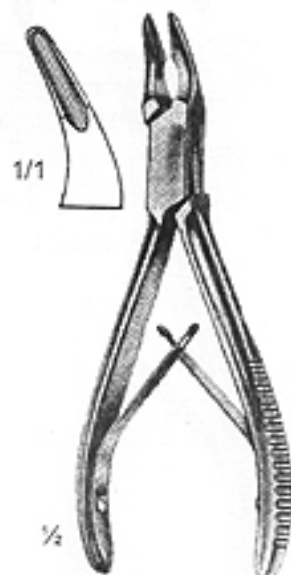

14-097-16
16 cm

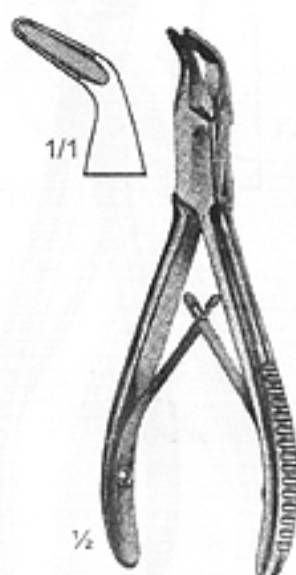

14-098-15
15 cm

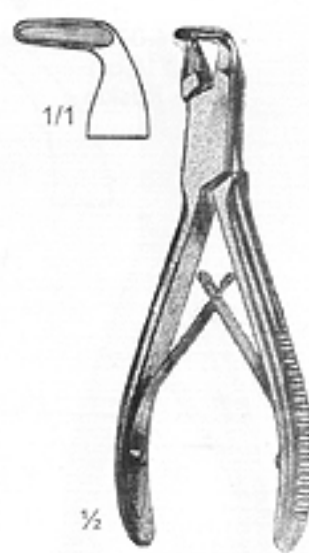

14-099-15
15 cm

Blumenthal

Department

15

MOUTH GAGS AND TONGUE RETRACTOR
MUNDSPERER UND ZUNGENHALTER
ABRE BOCAS Y ABAJA LENGUA

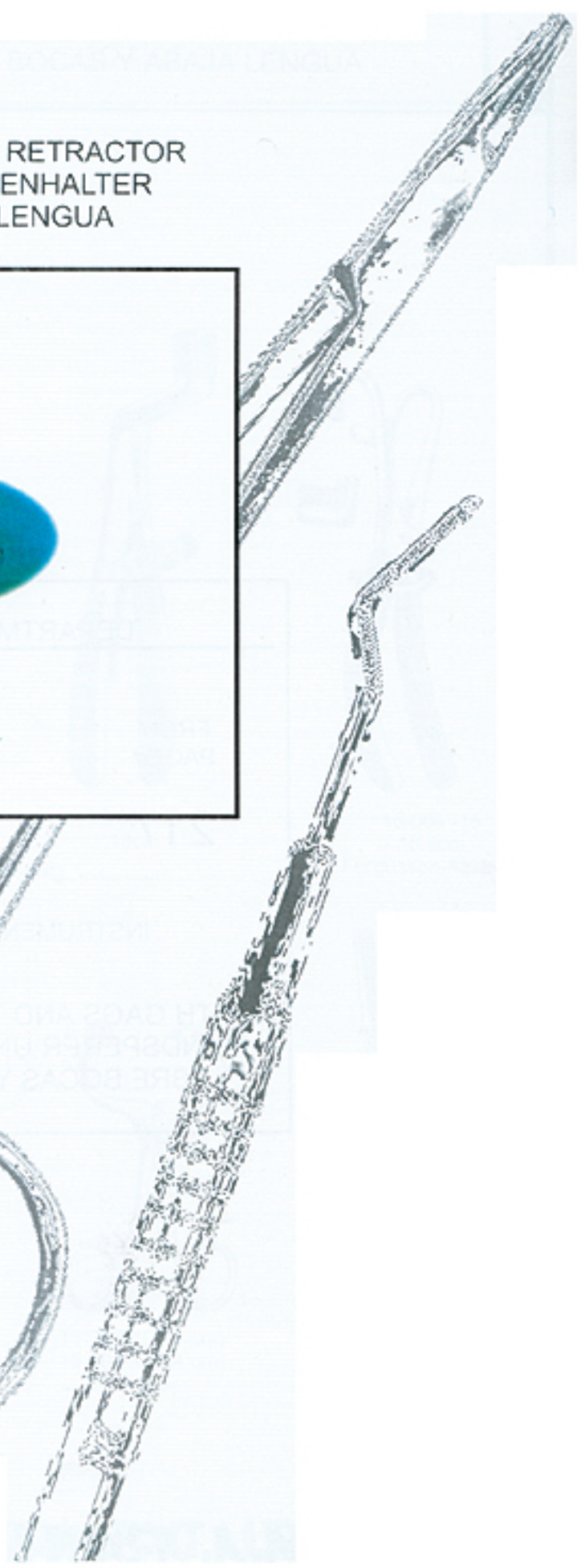
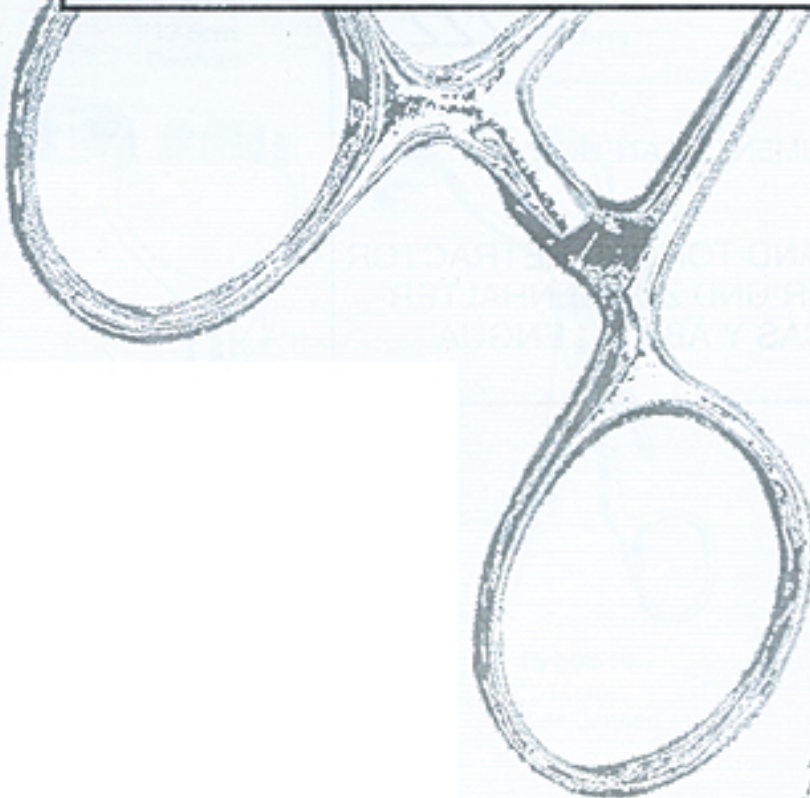
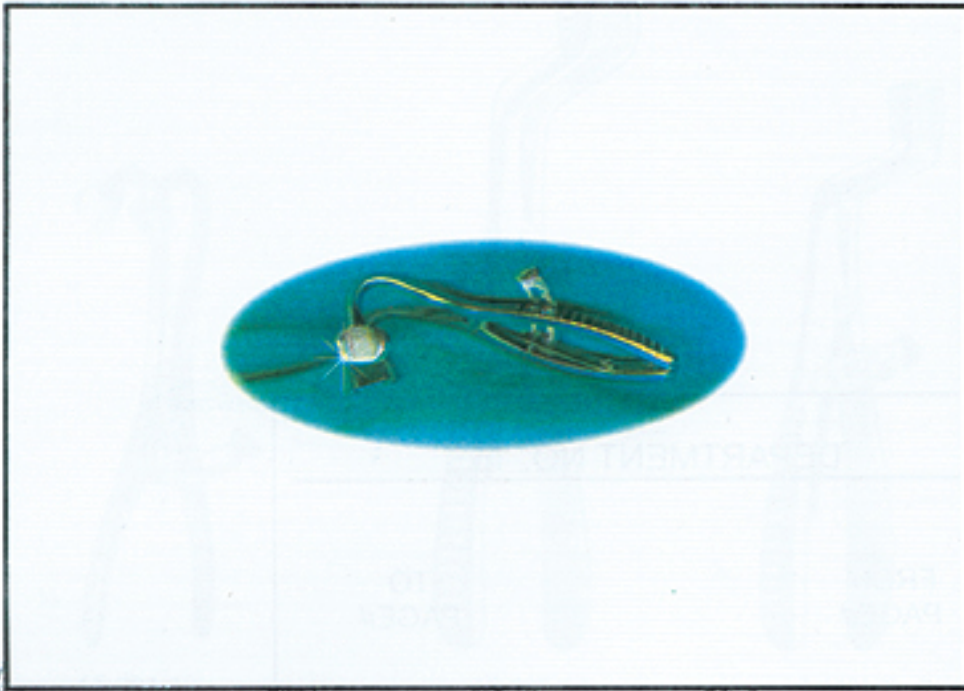

DEPARTMENT NO. 15

FROM
PAGE#

TO
PAGE#

217

222

INSTRUMENTS CATEGORY

MOUTH GAGS AND TONGUE RETRACTOR
MUNDSPERER UND ZUNGENHALTER
ABRE BOCAS Y ABAJA LENGUA



15-001-12
12.5cm
Denhart



15-002-18
18.5cm



15-003-16
16cm

Roser-Konig



15-004-15
15.5cm
Fergusson-Ackland



15-005-12
12cm
Doyen-Collin

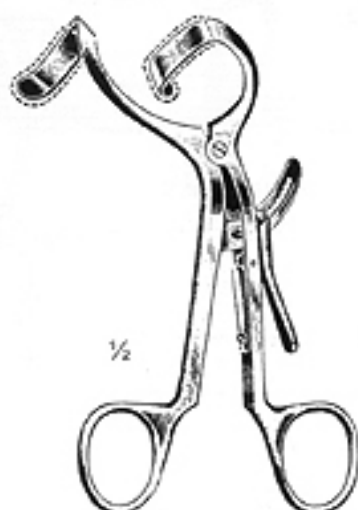

15-006-14
14cm
Doyen-Jansen



15-007-10(10 cm)
15-007-14(14 cm)
Molt



15-008-13
13cm
Heister

MOUTH GAGS
MUNDSPERRER
ABRE-BOCAS



ARAIN



15-050-09(9CM)
15-050-11(11CM)
15-050-13(13CM)
15-050-15(15CM)
Jennings

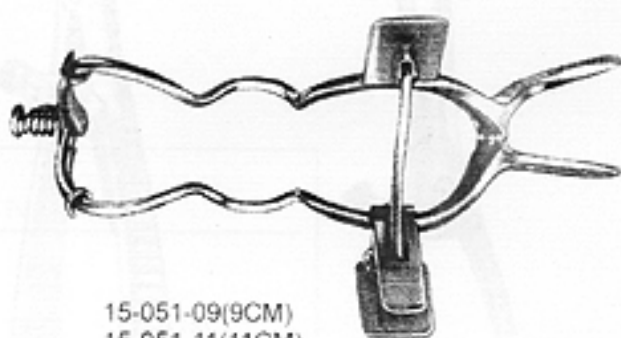

15-051-09(9CM)
15-051-11(11CM)
15-051-13(13CM)
15-051-15(15CM)
Seemann-Seiffert
(Self-retaining)



15-052-11(11CM)
15-052-13(13CM)
15-052-15(15CM)



15-053-13(13CM)

Whitehead



MOUTH GAGS
MUNDSPERRER
ABRE-BOCAS

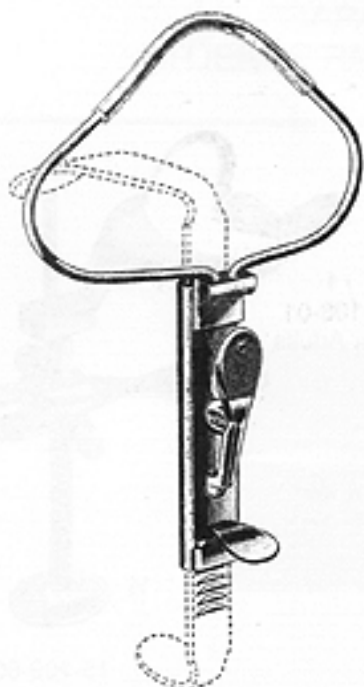

15-054-00

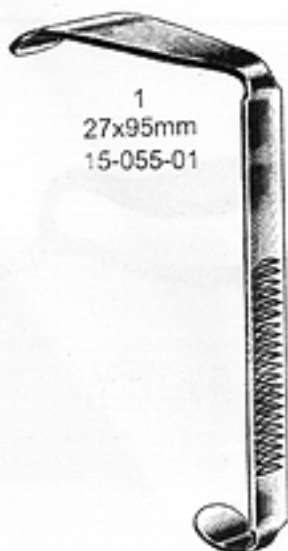

1
27x95mm
15-055-01



2
22x85mm
15-055-02



3
22x70mm
15-055-03

1-3
15-055-00
McIvor



1/2
15-056-00



1
27x105mm
15-057-01

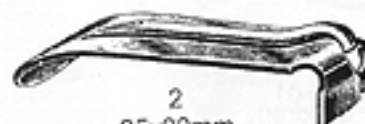

2
25x90mm
15-057-02



3
25x75mm
15-057-03



4
22x60mm
15-057-04



5
20x25mm
15-057-05

1-5
15-057-00
Davis-Boyle

TONGUE DEPRESSOR
ZUNGEN-UND WATTEROLLENHALTER
ABASSE-LANGUE AVEC ABAISSE-TAMPON





3
15-108-03
For Adults

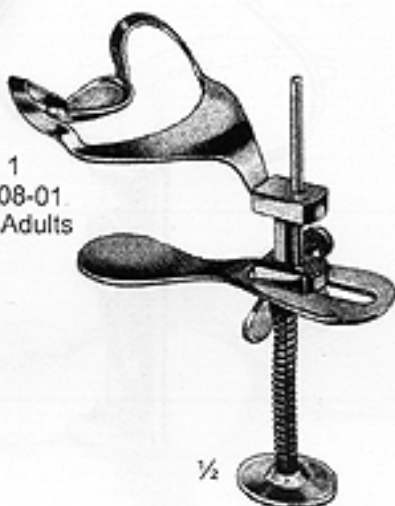

1
15-108-02
For Adults

1
15-108-01
For Adults



1/2

15-109-00
Automaton



1
15-110-01
For Children



2
15-110-02
For Children



3
15-110-03
For Children

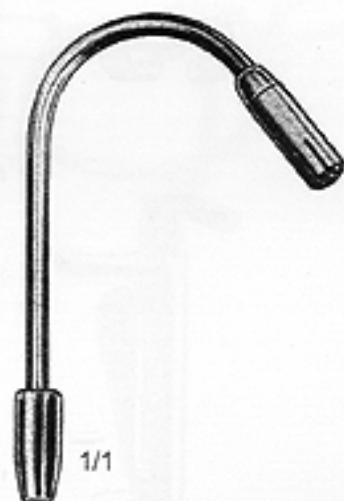

1/1

15-111-00
Saliva Ejectors(metal)

Department

16

DISSECTING SCISSORS
PRAPARIERSCHEREN
TIJERAS PARA PREPARACIONES

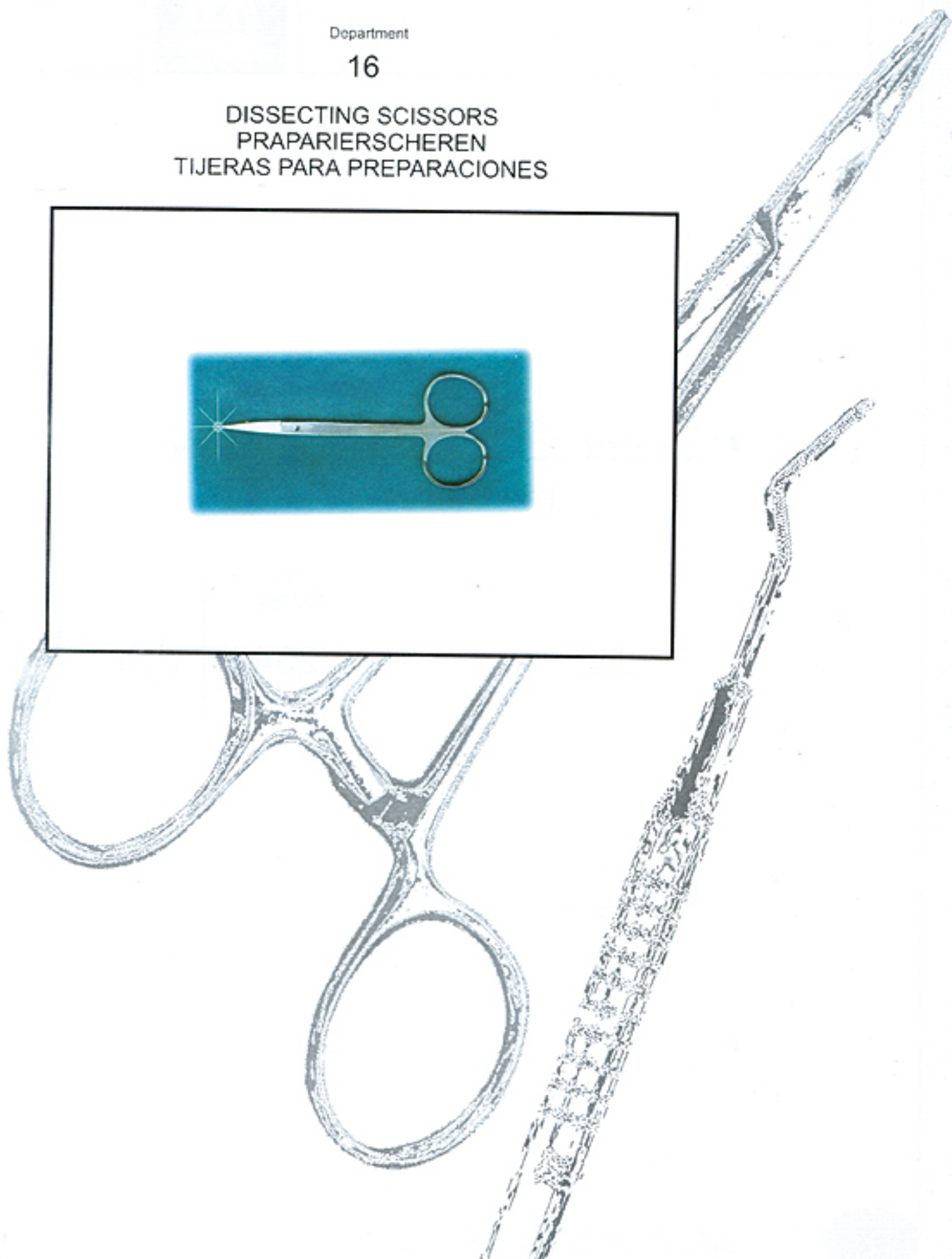

DEPARTMENT NO. 16

FROM
PAGE#

223

TO
PAGE#

234

INSTRUMENTS CATEGORY

DISSECTING SCISSORS
PRAPARIERSCHEREN
TIJERAS PARA PREPARACIONES



ARAIN

OPERATING SCISSORS
CHIRURGISCHE SCHEREN
TIJERAS PARA CIRUGIA

16



16-001-14
14.5 cm

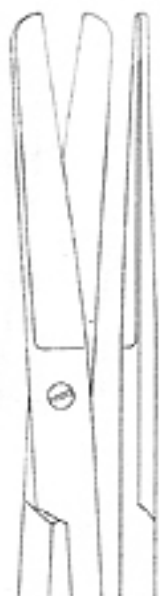

16-002-14
14.5 cm



16-003-14
14.5 cm



16-004-14
14.5 cm



16-005-14
14.5 cm



16-006-14
14.5 cm



OPERATING SCISSORS
CHIRURGISCHE SCHEREN
TIJERAS PARA CIRUGIA



16-010-09
9.5 cm
O'Brien



16-009-12
12.5 cm
Northbent



16-008-09
9 cm
Shortbent



16-007-09(9 cm)
16-007-10(10.5 cm)
16-007-13(13 cm)
Spencer

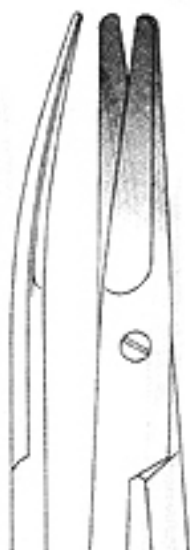

16-013-14

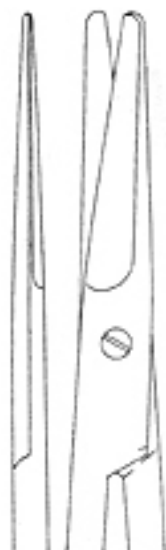

16-012-14



16-012-14
16-013-14
14.5 cm
Mayo



16-011-11
11.5 cm



DISSECTING SCISSORS
PRAPARIERSCHEREN
TIJERAS PARA PREPARACIONES

16

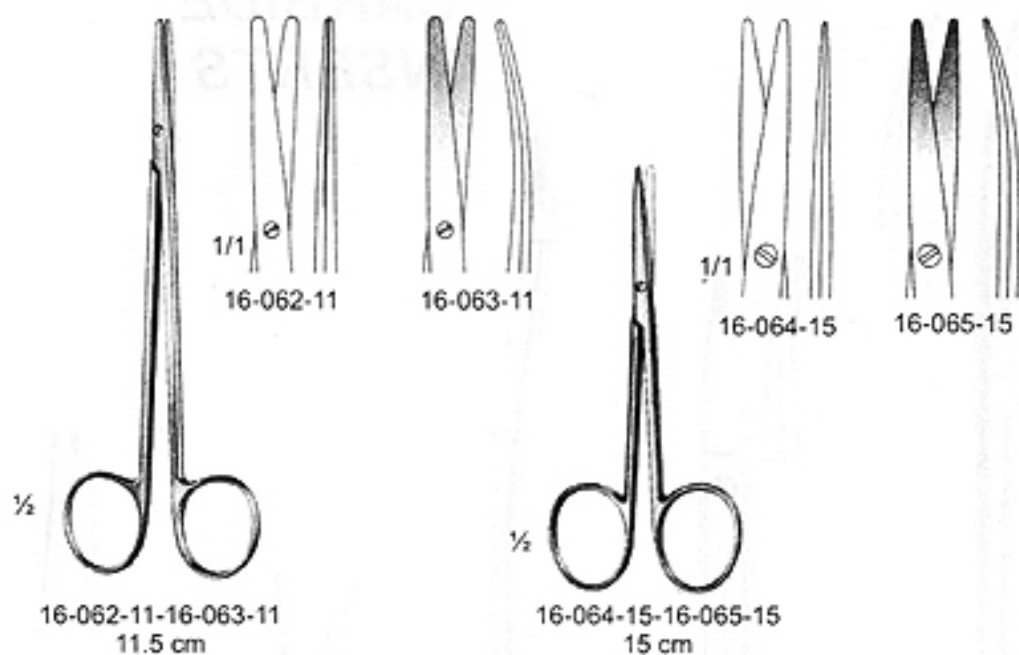

Metzenbaum

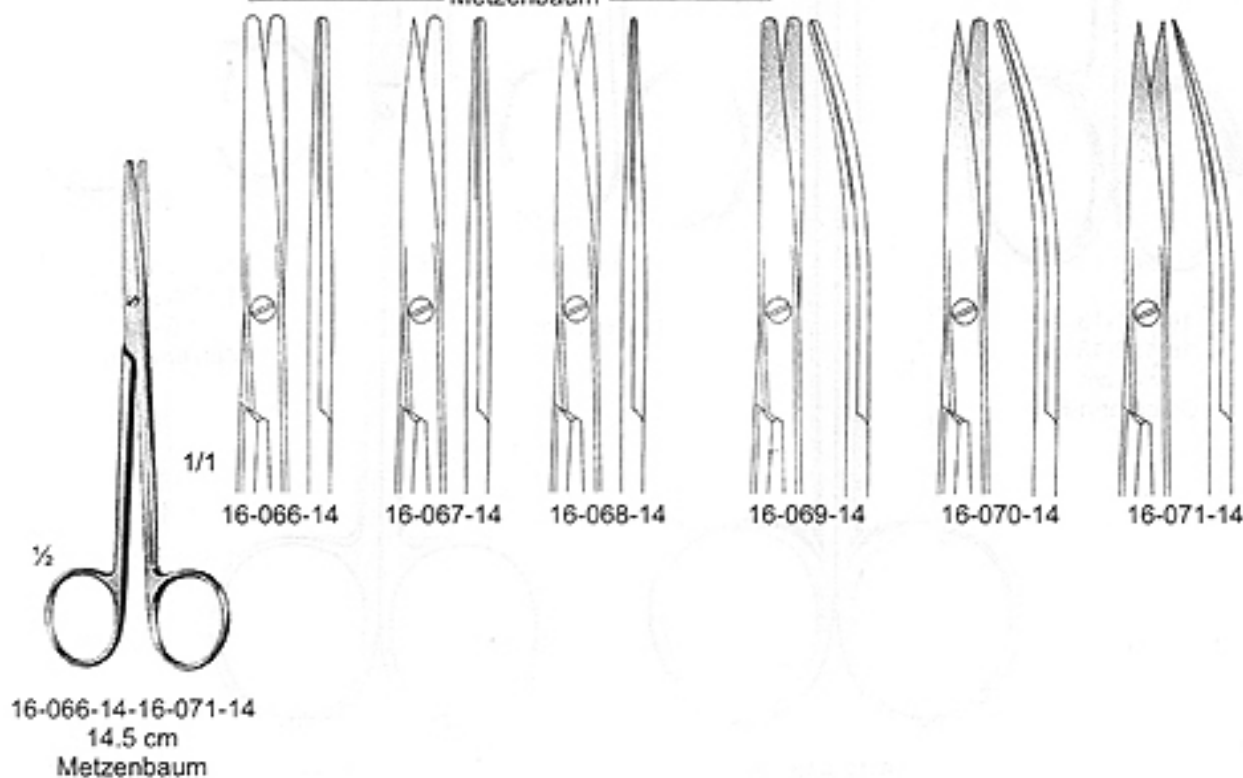



**TUNGSTEN
CARBIDE
INSERTS**



16-121-13 str
16-122-13 cur
13 cm
Goldmann-Fox

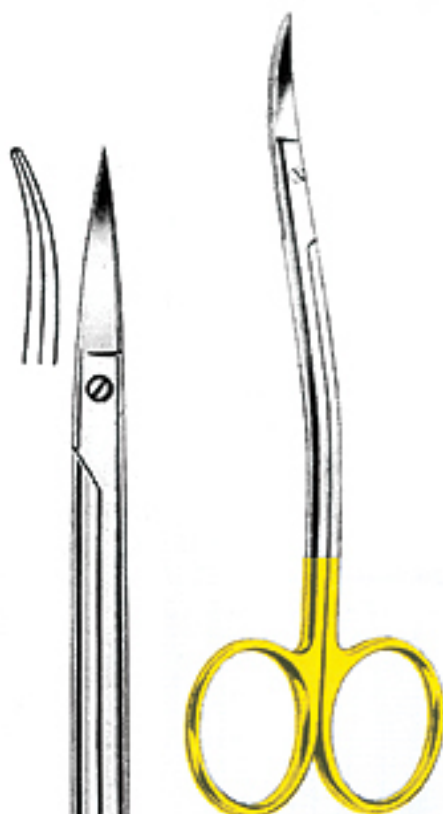

16-125-11
11 cm
La Grange

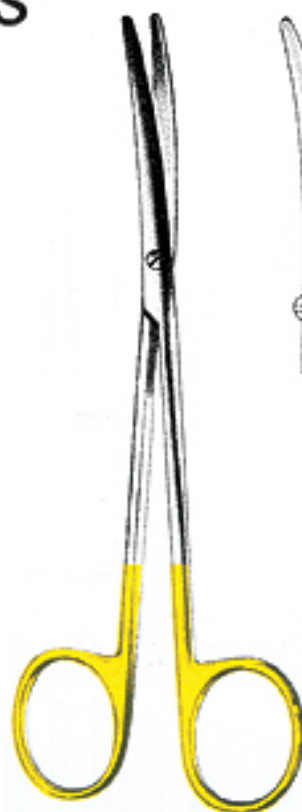

16-128-14 str
16-129-14 cur
14.5 cm
Metzenbaum



16-123-16 str
16-124-16 cur
16 cm
Kelly

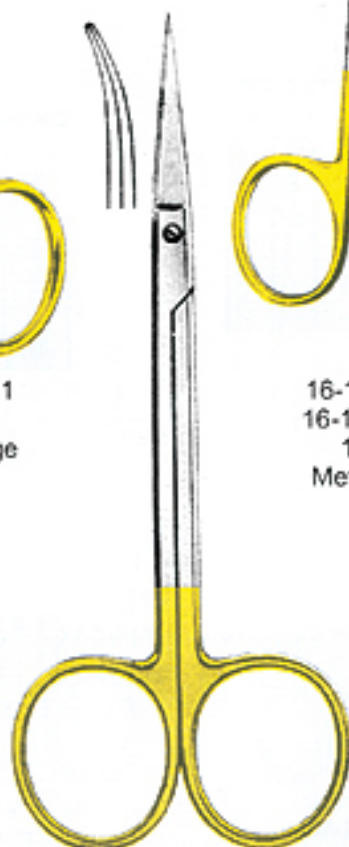

16-126-11 str
16-127-11 cur
11.5 cm



ARAIN

**GUM SCISSORS
ZAHNFLEISCHSCHEREN
TIJERAS PARA ENCIAS**

16



16-178-11-16-179-11
11.5 cm

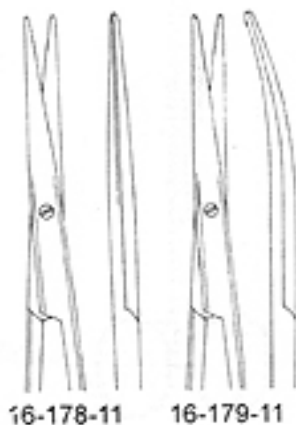

16-178-11 16-179-11

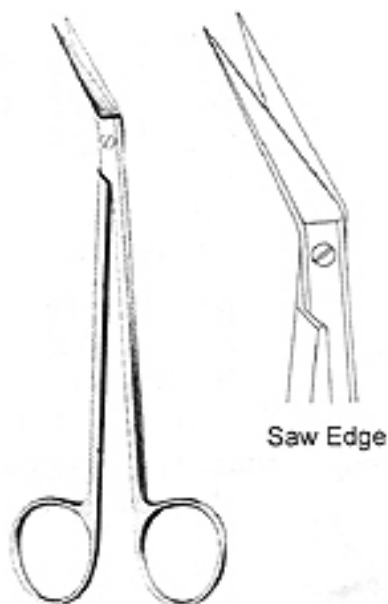

16-180-16
16 cm
Locklin



16-181-17-16-182-17
17 cm
Dean



16-181-17



16-182-17
Saw Edge

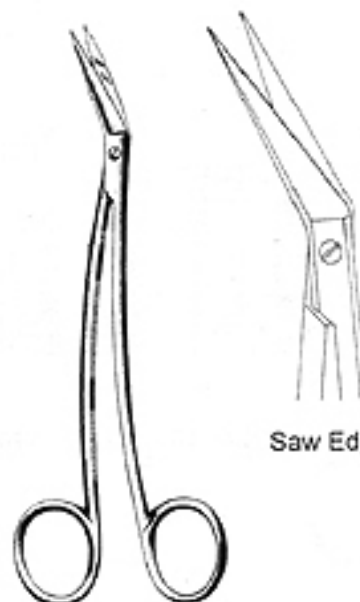

16-183-16
16 cm
locklin

FINE OPERATING SCISSORS
FEINE CHIRURGISCHE SCHERE
TIJERAS FINAS PARA CIRUGIA

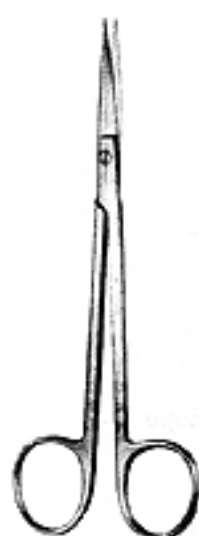
16-244-14



16-245-14

16-244-14-16-245-14
14 cm
Sanvenero



16-246-14



16-247-14

16-246-14-16-247-14
14 cm
Joseph

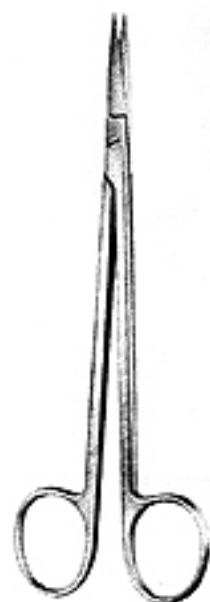

16-248-16

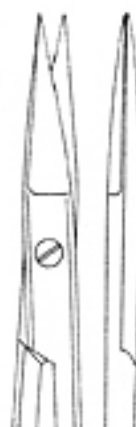

16-248-18



16-249-16



16-249-18

16-248-16-16-249-18
16 cm
18 cm
Kelly



ARAIN

GUM SCISSORS
CISEAUX A GENCVES
TIJERAS PARA RNCIAS

16



16-300-11
11.5 cm
La Grange

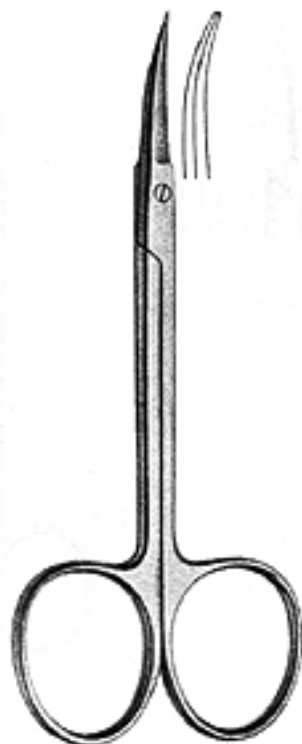

16-301-11
11.5 cm
Iris

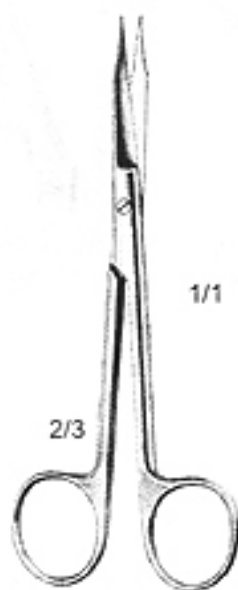

1
16-302-13
13 cm



1/1

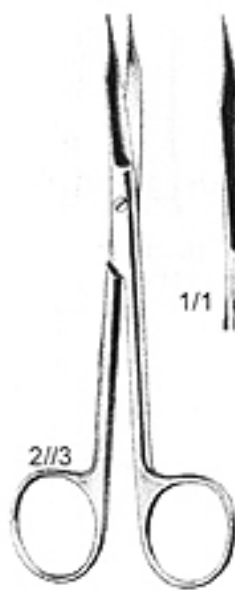

2
16-303-13
13 cm

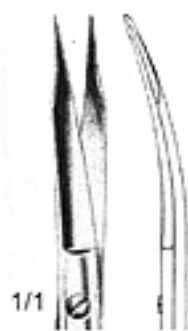

1/1

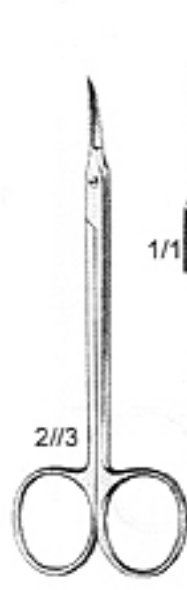

16-304-11
11 1/2 cm



1/1

GUM SCISSORS
ZAHNFLEISCH SCHEREN
TIJERAS PARA ENCIAS

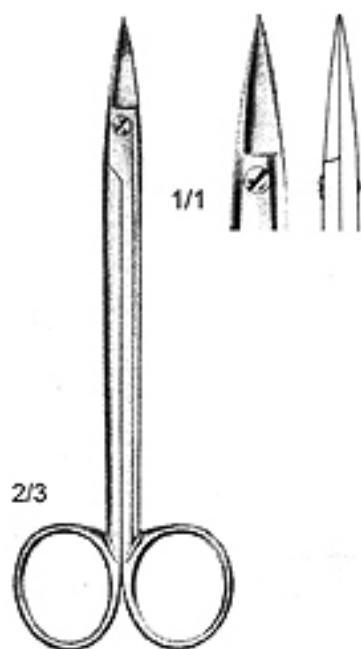

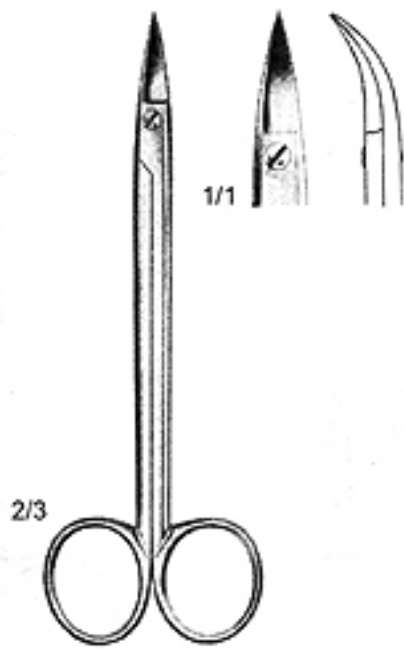

1
16-305-12
12.5 cm

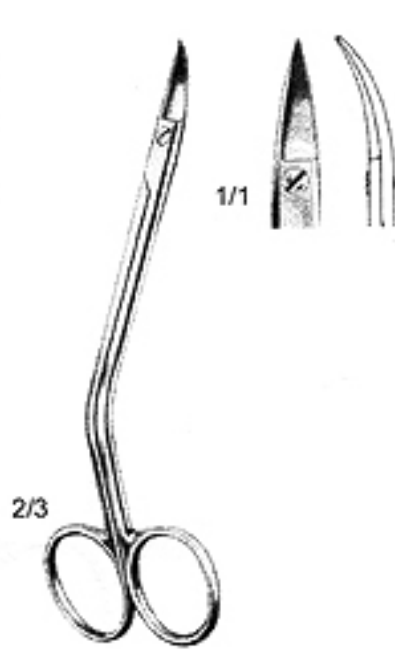

2
16-306-12
12.5 cm

Quinby



16-307-12
12 cm
Neumann

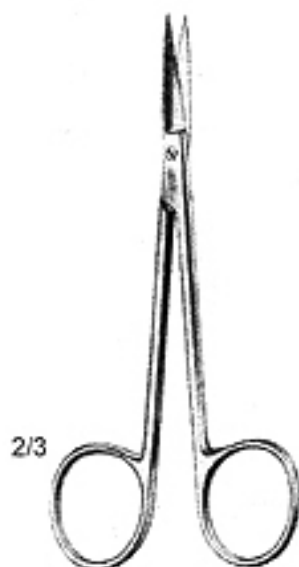

1-4
16-308-11
11 cm
Iris

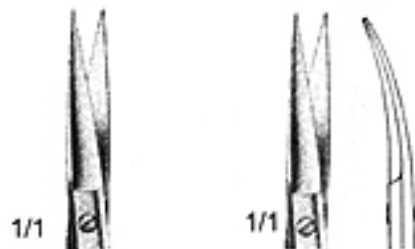

16-309-11
11 cm

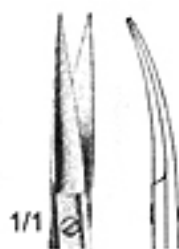

16-310-11
11 cm



16-311-11
11 cm



16-312-11
11 cm



GUM SCISSORS
ZAHFLEISCH SCHEREN
TIJERAS PARA ENCÍAS

16

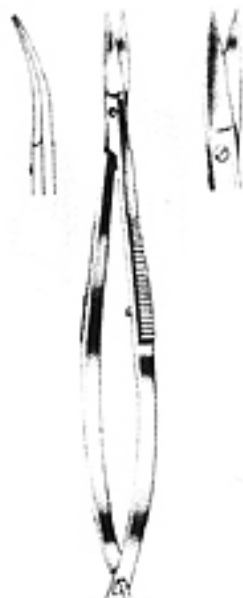

16-313-12
12 cm
Noyes

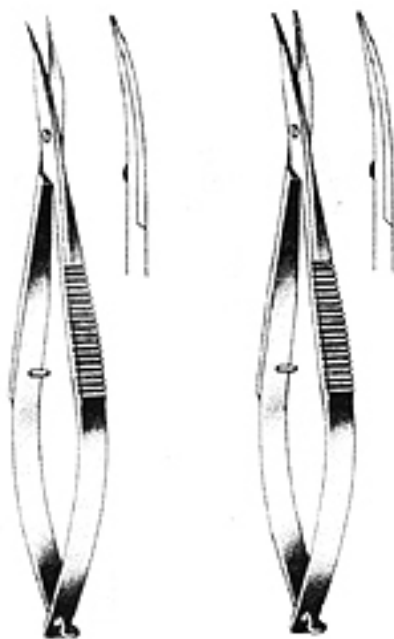

16-314-11 11 cm
16-315-11 11 cm
Westcott



16-316-00



16-317-15
15 cm



16-318-15
15 cm



16-319-15
15 cm
Reill
Saw Edge

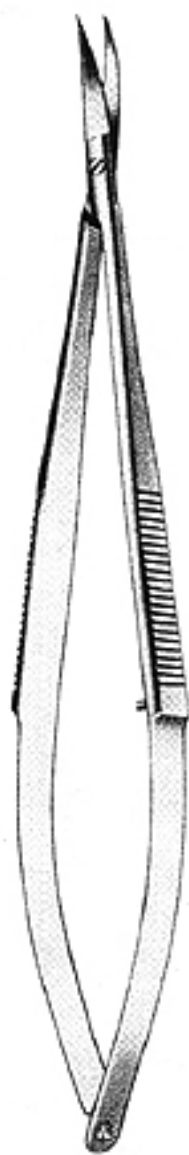

16-320-15
15 cm
Castroviejo

CROWN SCISSORS - CISEAUX A
KRONEN SCHEREN
TIJERAS PARA CORONOS

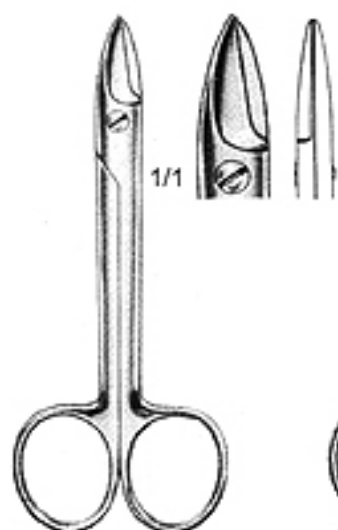
16-365-10
10.5 cm
Beebee

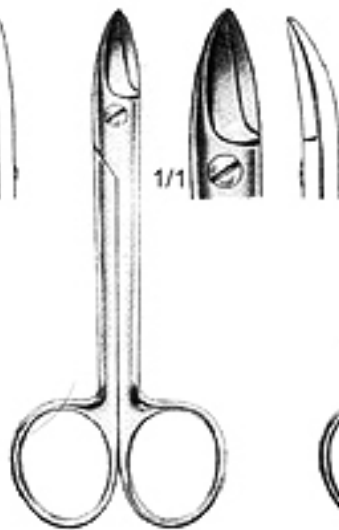

16-366-10
10.5 cm
Beebee

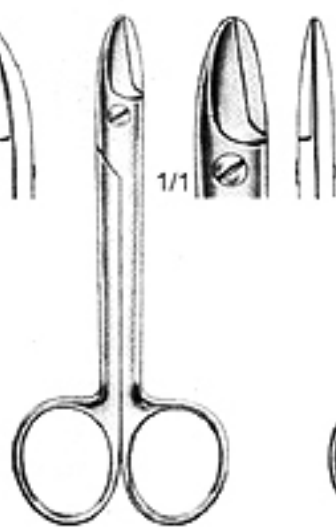

16-367-10
10.5 cm
Beebee

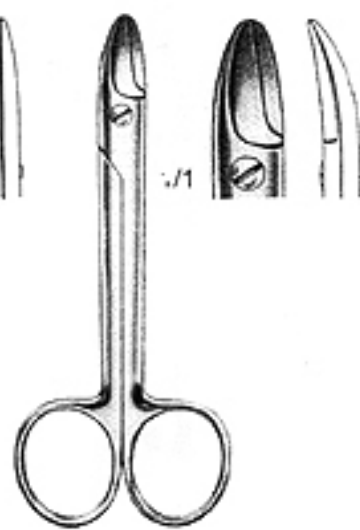

16-368-10
10.5 cm
Beebee

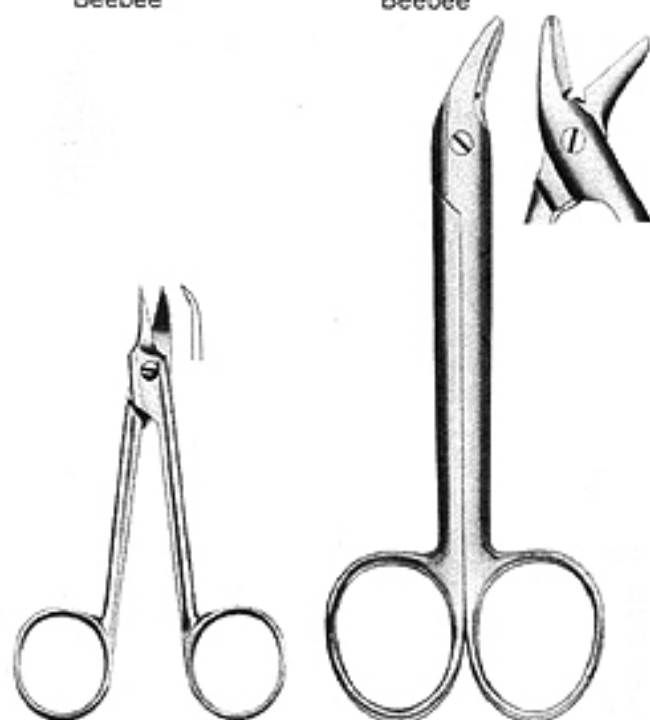

16-369-10
10.5 cm

16-370-12
12 cm
Universal

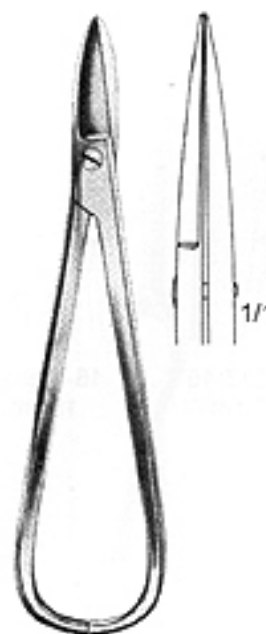

16-371-117
17 cm



16-372-117
17 cm

Department

17

TISSUE RETRACTORS
WEICHTEILHAKEN
SEPARADORES

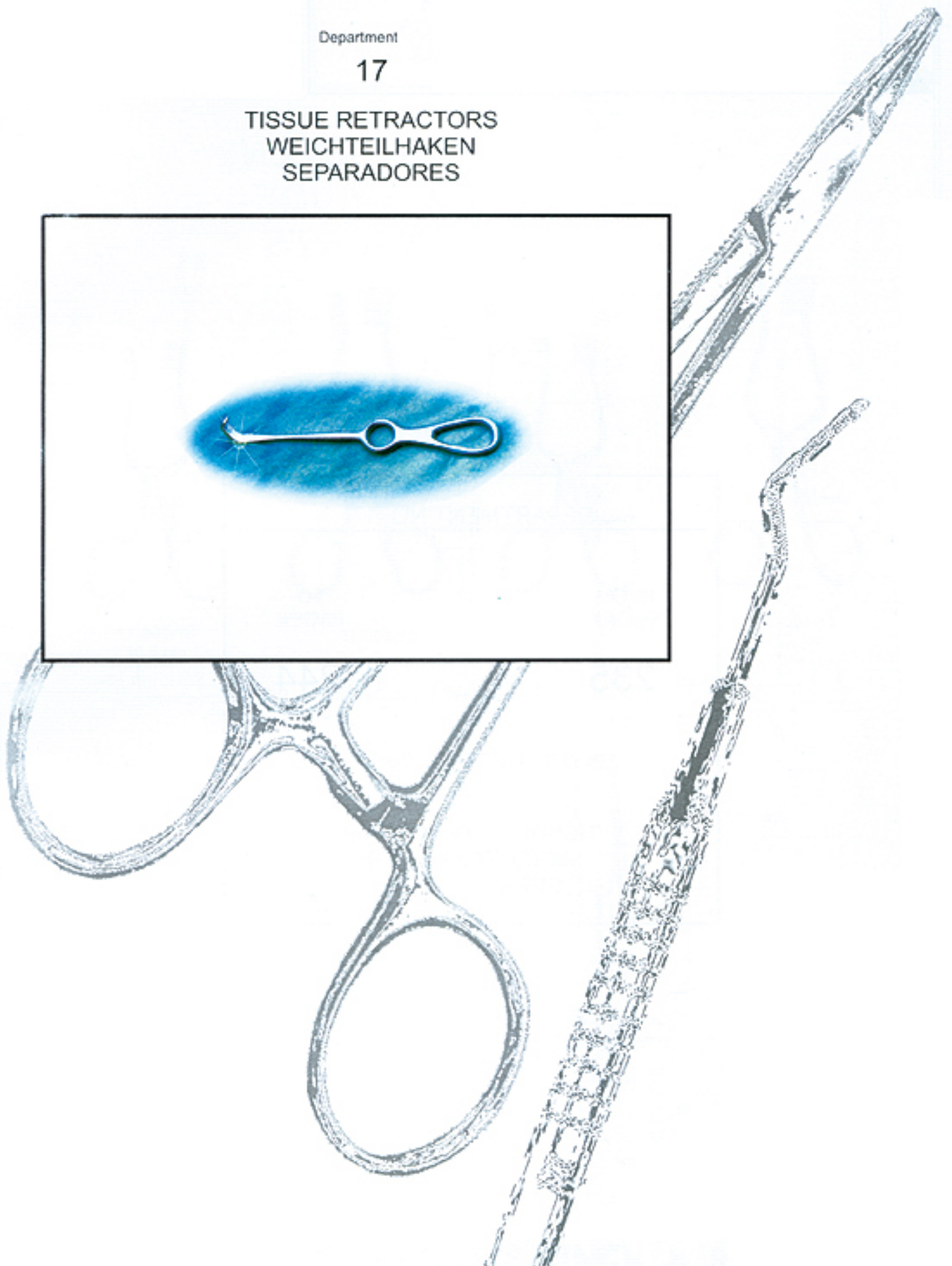
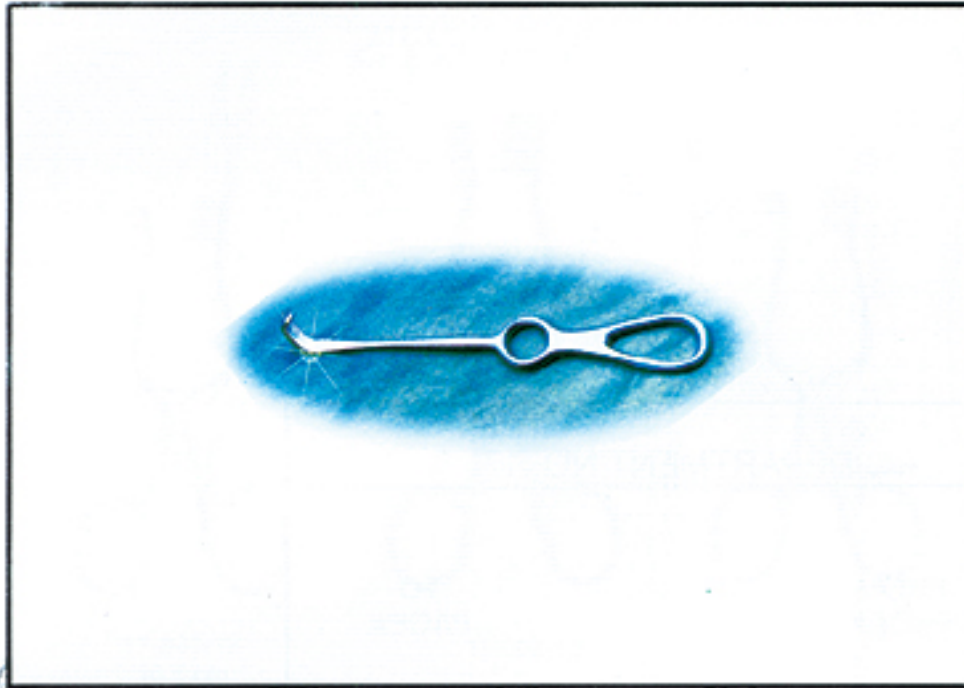



DEPARTMENT NO. 17

FROM
PAGE#

235

TO
PAGE#

244

INSTRUMENTS CATEGORY

TISSUE RETRACTORS
WEICHTEILHAKEN
SEPARADORES



PETRACTORS - MOUTH GAGS
 ECARTEURS - OUVRE - BOUCHES
 SEPARADORES - ABRE - BOCAS

17



17-001-10
10.5 cm

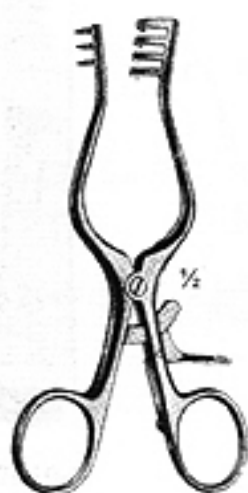

17-002-13

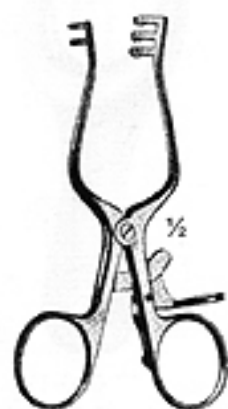

17-003-10
10.5 cm

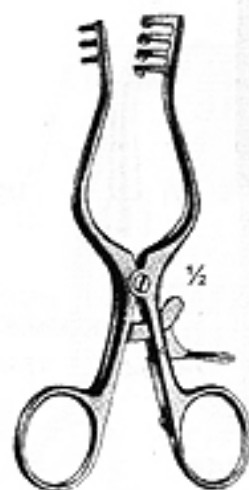

17-004-13
13 cm

Sharp ————— Weitlaner ————— Blunt

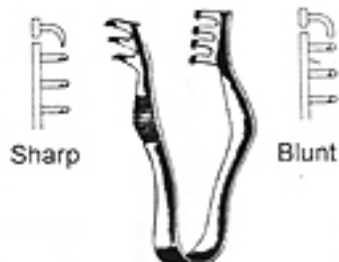

17-005-07(Sharp)
17-006-07(Blunt)
7 cm
Finisn

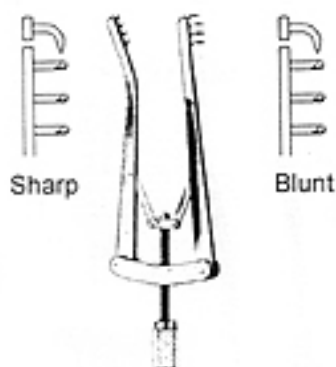

17-007-10(Sharp)
17-008-10(Blunt)
10 cm
Alm

RETRACTORS - MOUTH GAGS
 ECARTEURS - OUVRE-BOUCHES
 SEPARADORES - ABRE-BOCAS

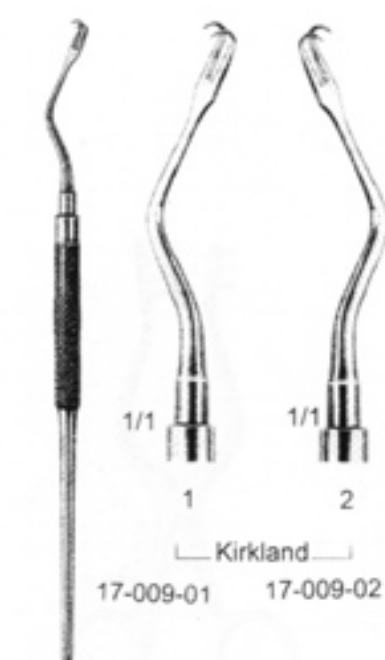

1/1 1 2
 Kirkland
 17-009-01 17-009-02

17-009-18
 18 cm



17-010-11
 11 cm
 Simplex



17-011-00
 Minnesota



17-011-14 14 cm
 17-011-15 15 cm
 Wieder



17-012-13
 13 cm
 Farabeuf



1/2 1/2
 17-013-12 (12 cm) 17-014-14 (14 cm)
 17-013-14 (14 cm) 17-014-16 (16 cm)
 17-013-16 (16 cm) 17-014-18 (18 cm)

Sternberg



1/2 17-015-00



1/2 17-016-00

Bruenings



1/1 1/2 1 17-017-00

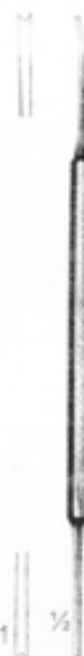

1/1 1/2 2 17-018-00

Luniatschek



RETRACTORS
ECARTEURS
SEPARADORES

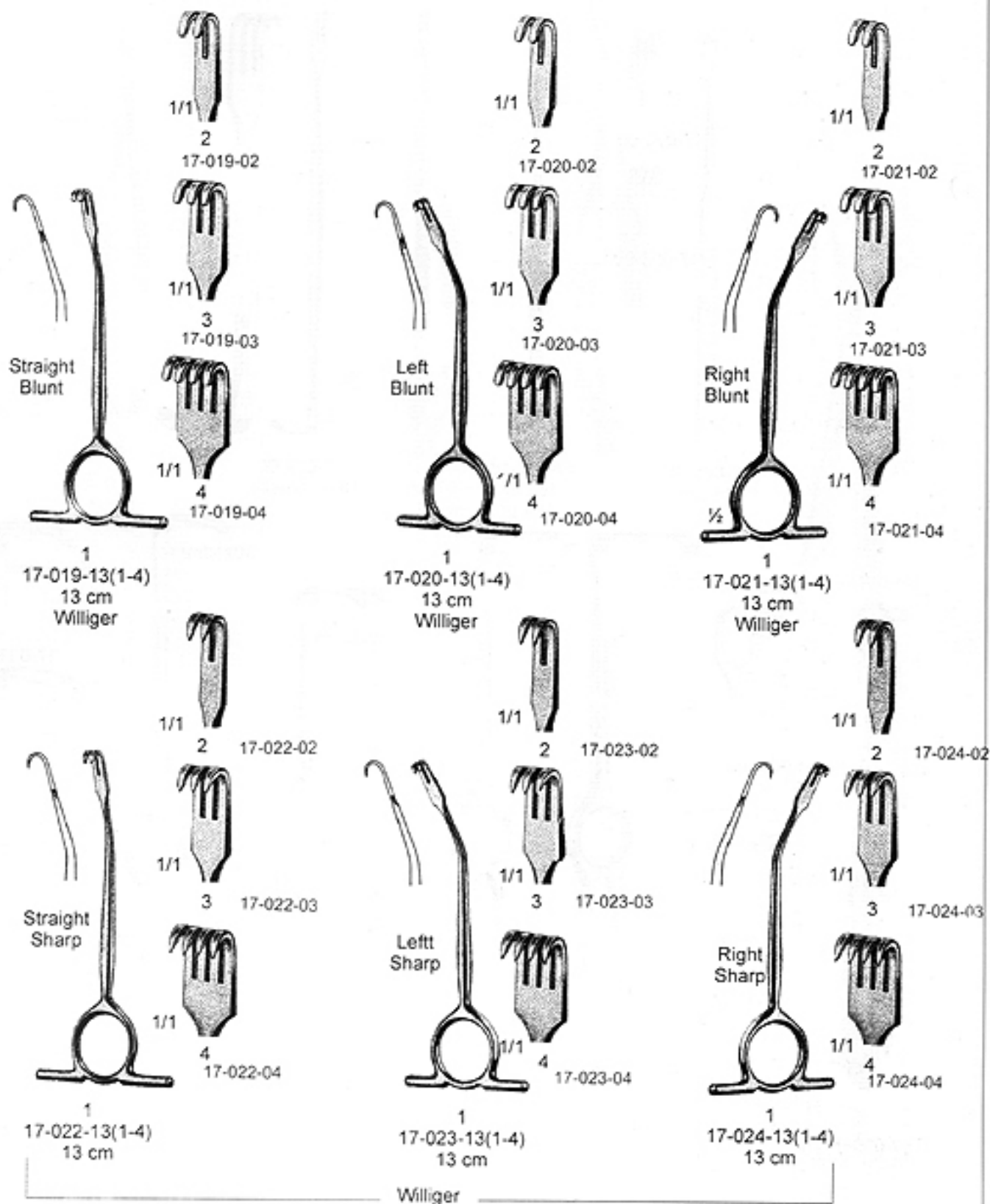

RETRACTORS
ECARTEURS
SEPARADORES



17-025-16
16 cm



17-027-16
16 cm
Sharp

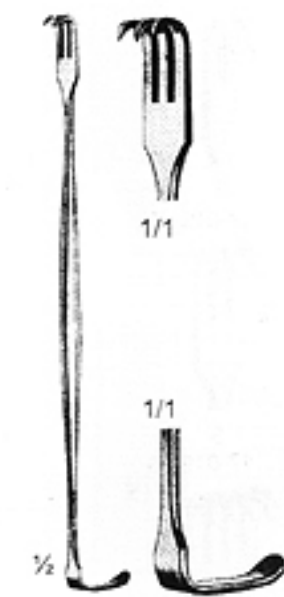

17-029-00
Senn-Mueller

15x15mm



1
17-030-01
Middeldorpf

20x22mm



17-030-02

28x28mm



17-030-03

56x11mm



17-031-21
21 cm

40x11mm



17-032-21
21 cm

Kocher

33x20mm



17-032-19
19 cm
Wassmund

30x10mm



1
17-033-22(1-5)
22 cm
Langenbeck

40x10mm



17-033-02

40x13mm



17-033-03

50x10mm



17-033-04

50x13mm



17-033-05



RETRACTORS
ECARTEURS
SEPARADORES

17



1/2

1-5
17-034-21
21 cm
Langenbeck



1
30x11mm

17-034-01

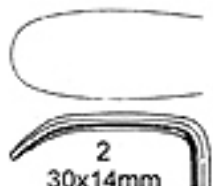

2
30x14mm

17-034-02

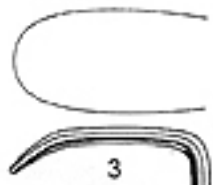

3
30x16mm

17-034-03



4
40x11mm

17-034-04

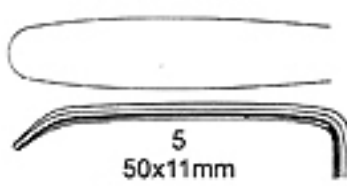

5
50x11mm

17-034-05



1/2



1

17-035-01



2

17-035-02



3

17-035-03



4

17-035-04

Sharp



1/1



5

17-035-05



6

17-035-06



7

17-035-07



8

17-035-08

Blunt

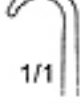

1/1

SOFT TISSUE RETRACTORS
WEICHTEILHAKEN
SEPARADORES

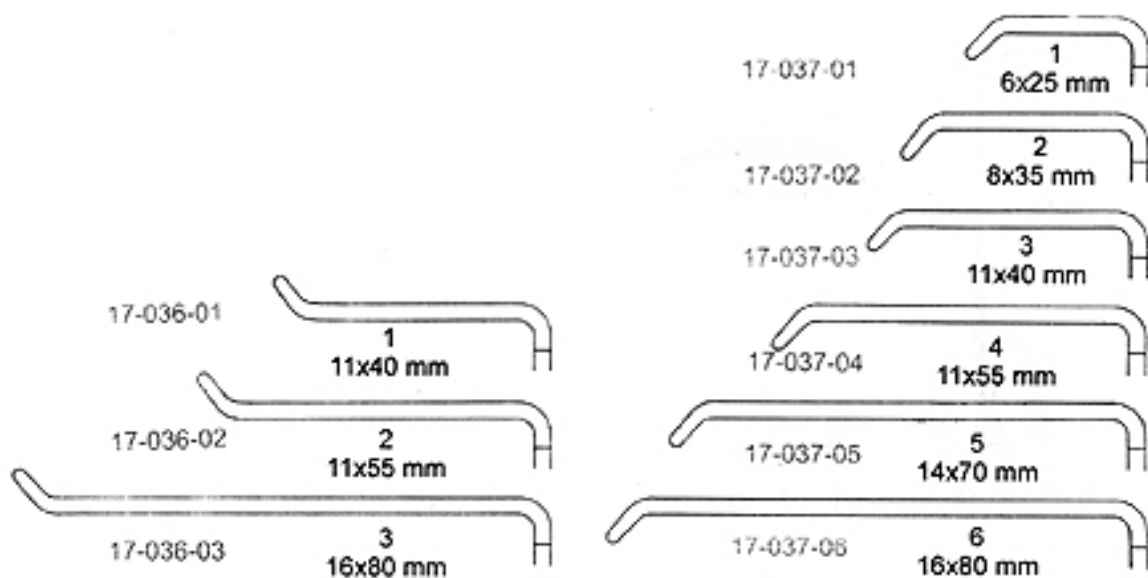
1-3
17-036-22
22 cm
Obwegeser



1-6
17-037-21
21.5 cm
Obwegeser
(Kocher-Langenbeck)



SOFT TISSUE RETRACTORS
WEICHTEILHAKEN
SEPARADORES

17

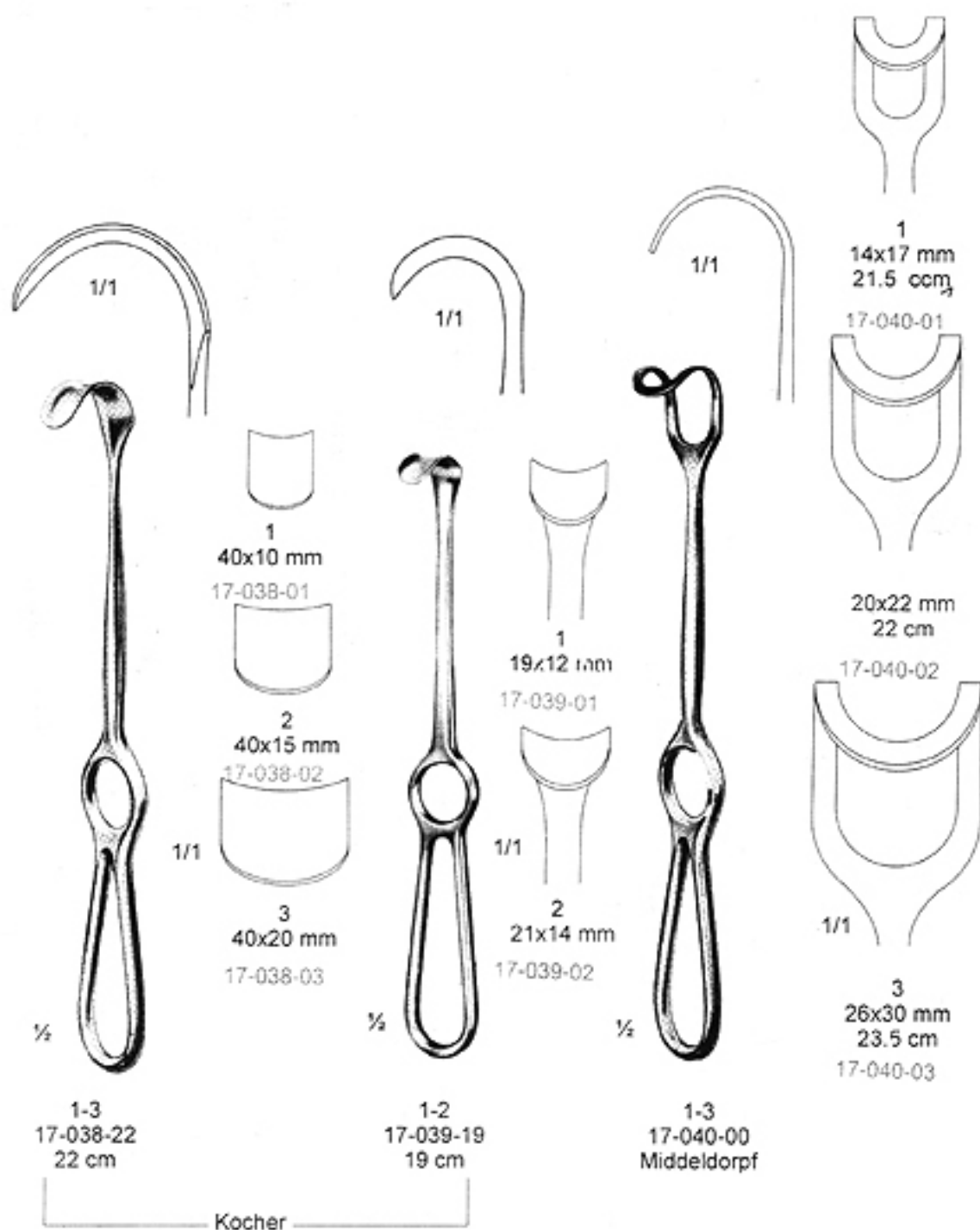

TISSUE RETRACTORS
WEICHTEILHAKEN
SEPARADORES



ARAIN

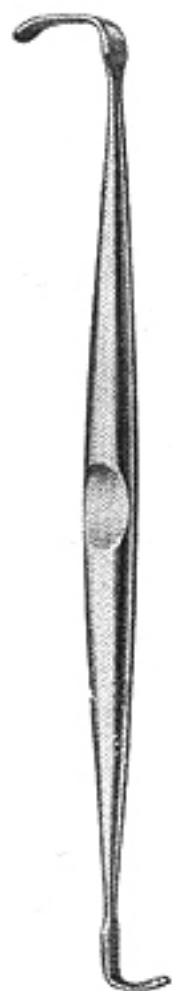

17-041-00
8x4 mm/15x5 mm
Ragnell - Davis



55x11 mm



1-2
17-042-22
22cm
Muller



1
25x7 mm
17-043-01



25x7 mm
17-043-02



1-2
17-043-00
Meyerding



33x20 mm



17-044-00
Wassmund



1
28x8 mm
17-045-01



2
35x11 mm
17-045-02

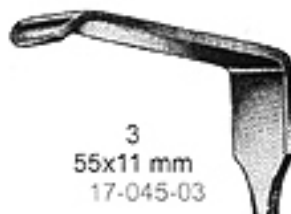

3
55x11 mm
17-045-03



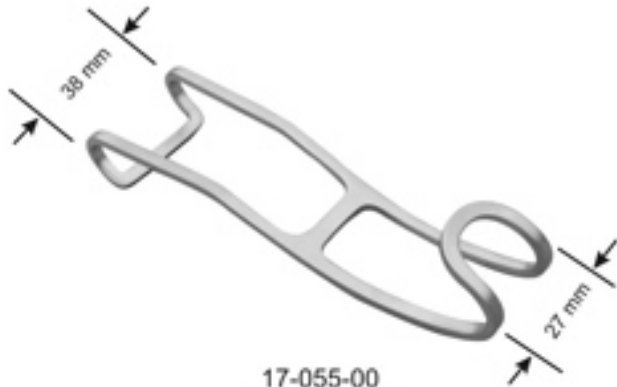

17-055-00
38 x 27 mm

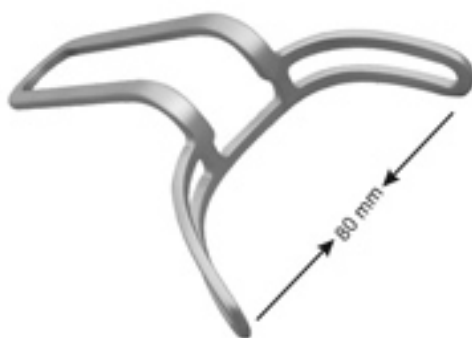

17-056-00
14 cm



Frazier (Fergusson)
17-057-06 Charr 6 mm
17-058-08 Charr 8 mm
17-059-10 Charr 10 mm
17-060-12 Charr 12 mm
18 cm

Department

18

ARTERY FORCEPS
ARTERIENKLEMMEN
PINZAS HEMOSTATICAS

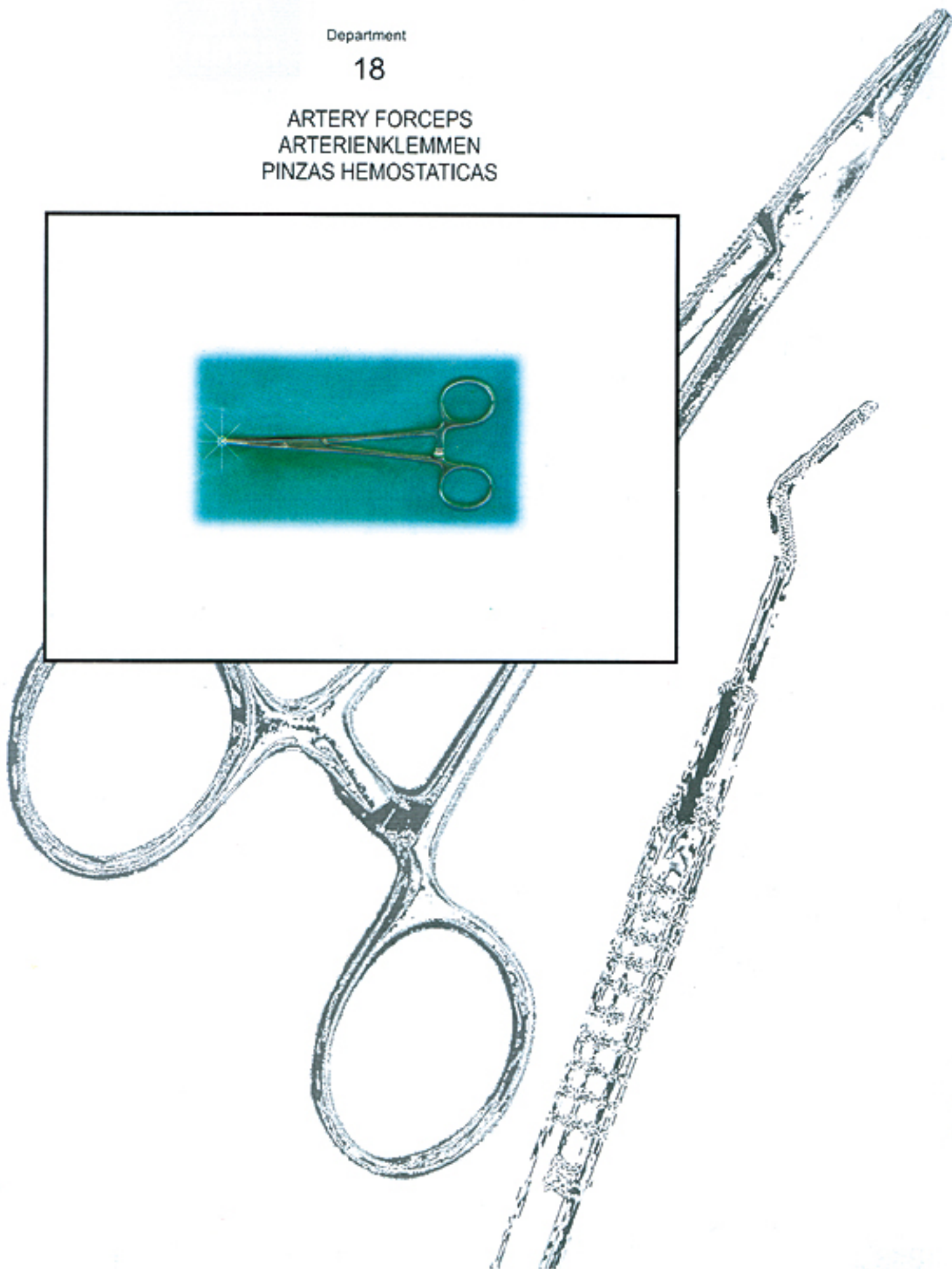
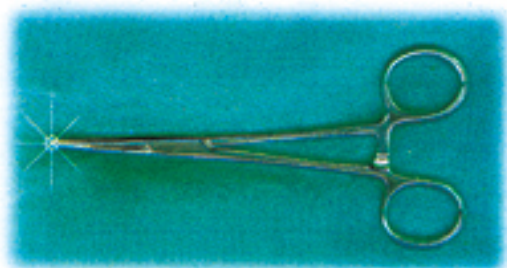

DEPARTMENT NO. 18

FROM
PAGE#

245

TO
PAGE#

253

INSTRUMENTS CATEGORY

ARTERY FORCEPS
ARTERIENKLEMMEN
PINZAS HEMOSTATICAS



ARTERY FORCEPS
ARTERIENKLEMMEN
PINZAS HEMOSTATICAS

18

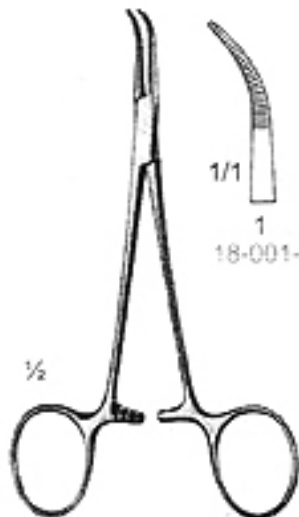

1-2
18-001-14
14 cm
Baby-Mixer

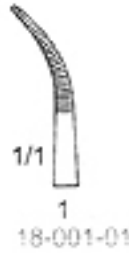

1/1
1
18-001-01

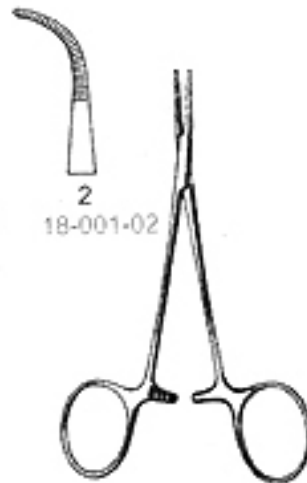

18-002-10-18-005-12
Micro-Mosquito



2
18-001-02



18-002-10
10 cm



18-002-12
12 cm



18-003-10
10 cm



18-003-12
12 cm



18-004-10
10 cm



18-004-12
12 cm



18-005-10
10 cm



18-005-12
12 cm

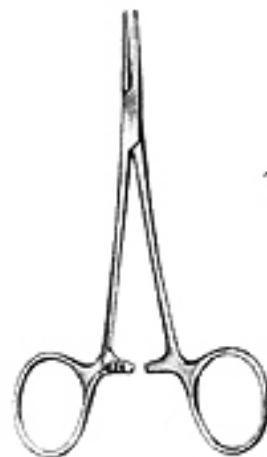

18-006-12-18-007-14
Haisted-Mosquito



18-006-12
12 cm



18-006-14
14 cm



18-007-12
12 cm



18-007-14
14 cm



18-008-12
12 cm



18-008-14
14 cm



18-009-12
12 cm



18-009-14
14 cm

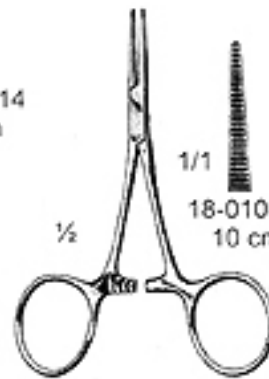

18-010-10-18-011-10
10 cm
Hartmann



1/1
18-010-10
10 cm



18-011-10
10 cm

ARTERY FORCEPS
ARTERIENKLEMMEN
PINZAS HEMOSTATICAS



18-012-09 Str
18-013-09 Cur
9 cm
Micro-Hartmann



18-014-09 Str
18-015-09 Cur
9 cm
Baby-Mosquito



18-016-09 Str
18-017-09 Cur
9 cm
Baby-Mosquito 1x2 teeth



18-018-10-10-021-12
Micro-Mosquito

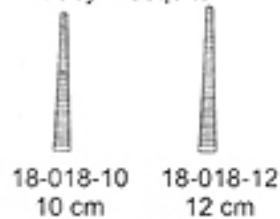

18-018-10 10 cm
18-018-12 12 cm

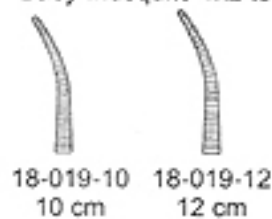

18-019-10 10 cm
18-019-12 12 cm

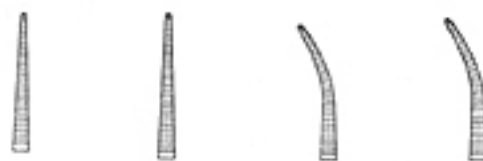

18-020-10 10 cm
18-020-12 12 cm
18-021-10 10 cm
18-021-12 12 cm
1x2 teeth

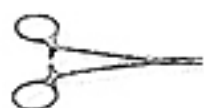

ARAIN

**ARTERY FORCEPS
ARTERIENKLEMMEN
PINZAS HEMOSTATICAS**

18



18-022-18-1. J25-21
Halsted-Mossquito



18-022-18
18 cm



18-022-21
18 cm



18-023-18
18 cm



18-023-22
18 cm



18-024-18
21 cm



18-024-21
21 cm



18-025-18
21 cm



18-025-21
21 cm

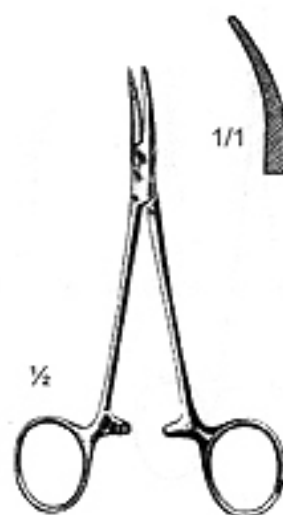

19-026-12
12 cm

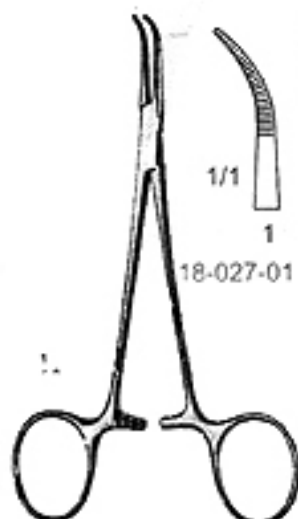

1-2
18-027-14
14 cm
Baby-Mixer



18-027-02

ARTERY FORCEPS
 ARTERIENKLEMMEN
 PINZAS HEMOSTATICAS

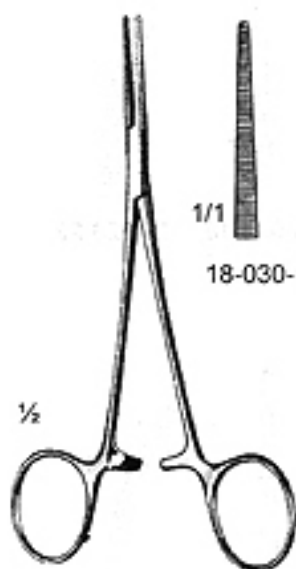
18-030-15-18-033-15
 15 cm
 Leriche



1/1

18-030-15



18-031-15



18-032-15



18-033-15

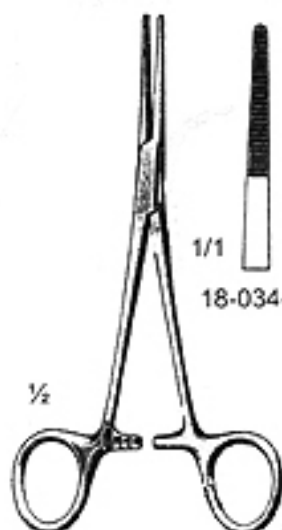

18-034-14-18-035-14
 14 cm
 Kelly



1/1

18-034-14



18-035-14

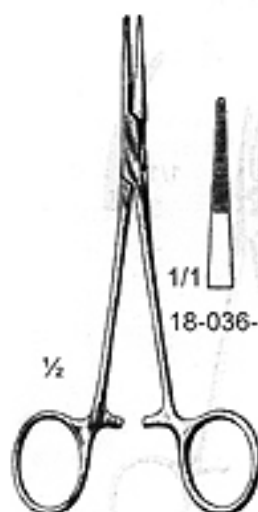

18-036-14-18-037-14
 14 cm
 Providence-Hospital



1/1

18-036-14



18-037-14



ARAIN

ARTERY FORCEPS
ARTERIENKLEMMEN
PINZAS HEMOSTATICAS

18



18-038-14-18-041-14
14 cm
Crile

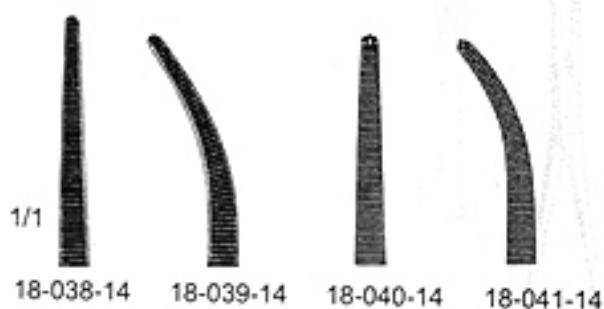

18-042-16-18-043-16
16 cm
Kelly-Rankin

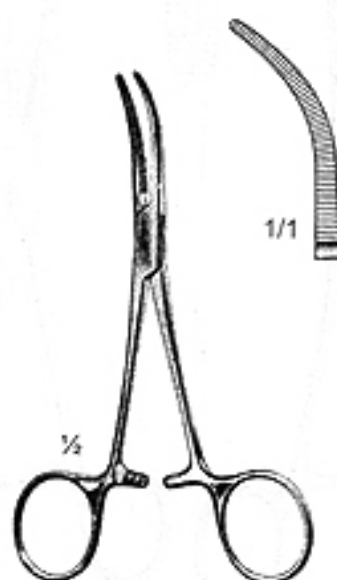
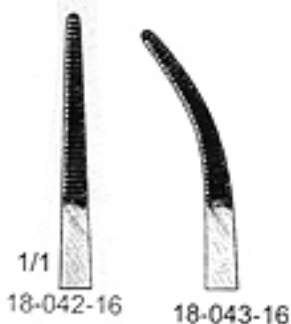

18-044-13
13.5 cm
Baby-Overholt



ARTERY FORCEPS
 ARTERIENKLEMMEN
 PINZAS HEMOSTATICAS

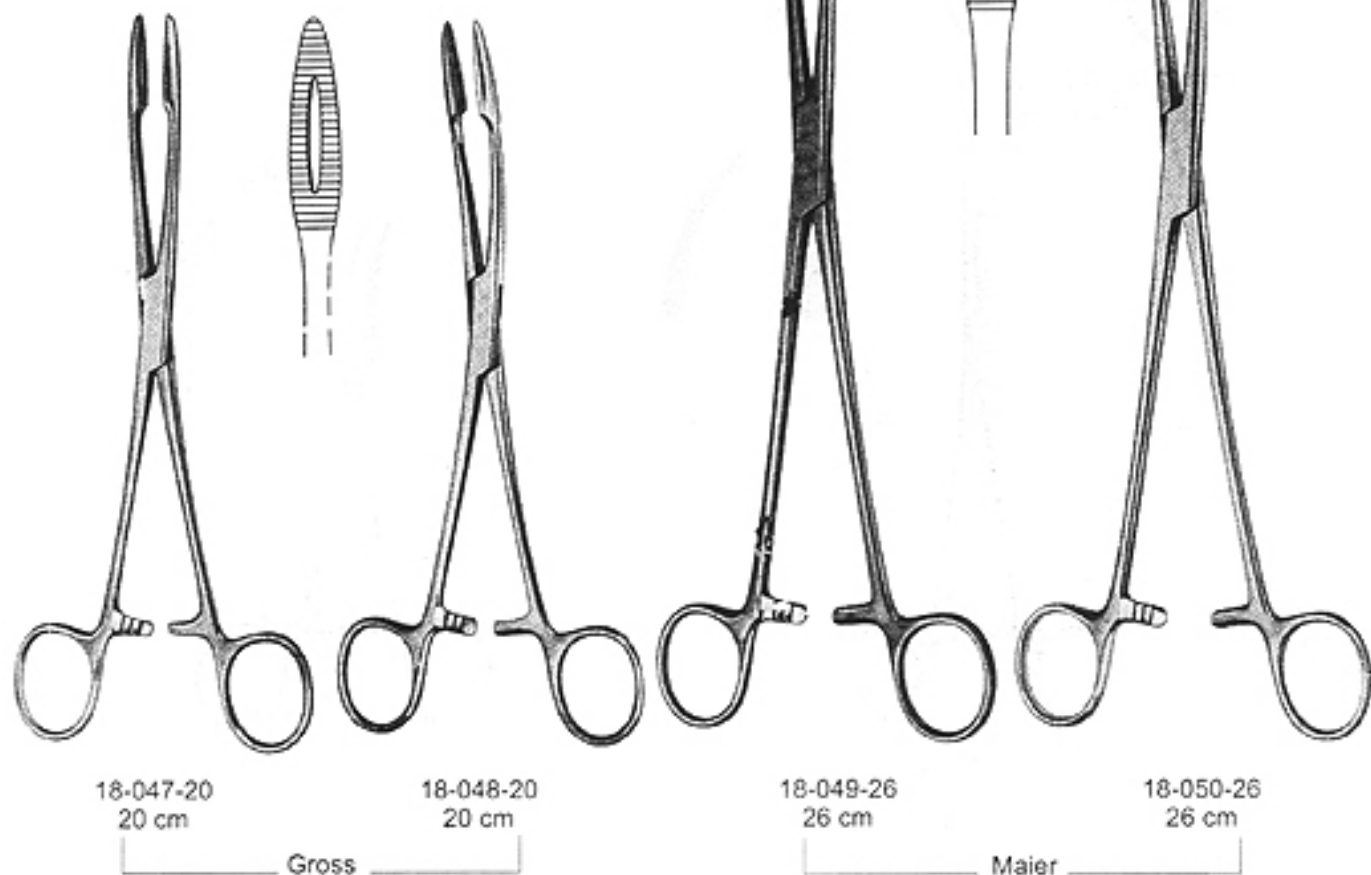
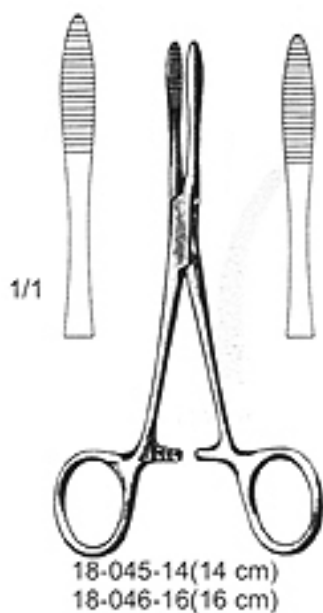

TOWEL FORCEPS
TUCHKLEMMEN
PINZAS PARA COMPRESAS, PINZAS DE CAMPO

18



18-051-05
5.5 cm



18-052-08
8 cm
Jones



18-053-18
18 cm
Schaedel



18-054-08
8 cm

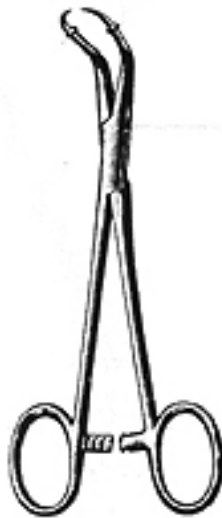

18-055-13(13 cm)
18-055-15(15cm)
Roeder



18-056-08(8.5 cm)
18-056-10(10 cm)



18-057-13(13 cm)
18-057-15(15 cm)

Backhaus

Department

19

NEEDLE HOLDERS
NADELHALTER
PORTA-AGUJAS

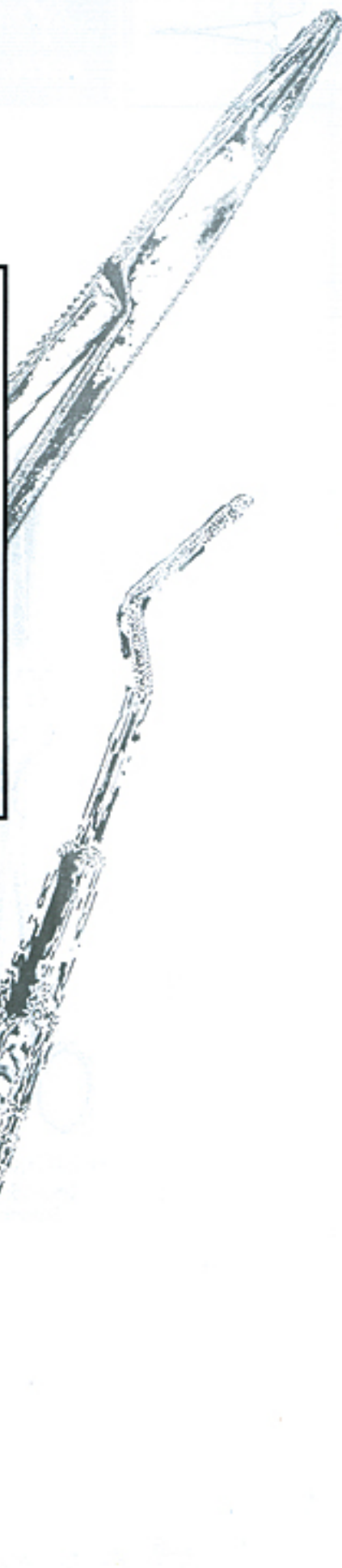
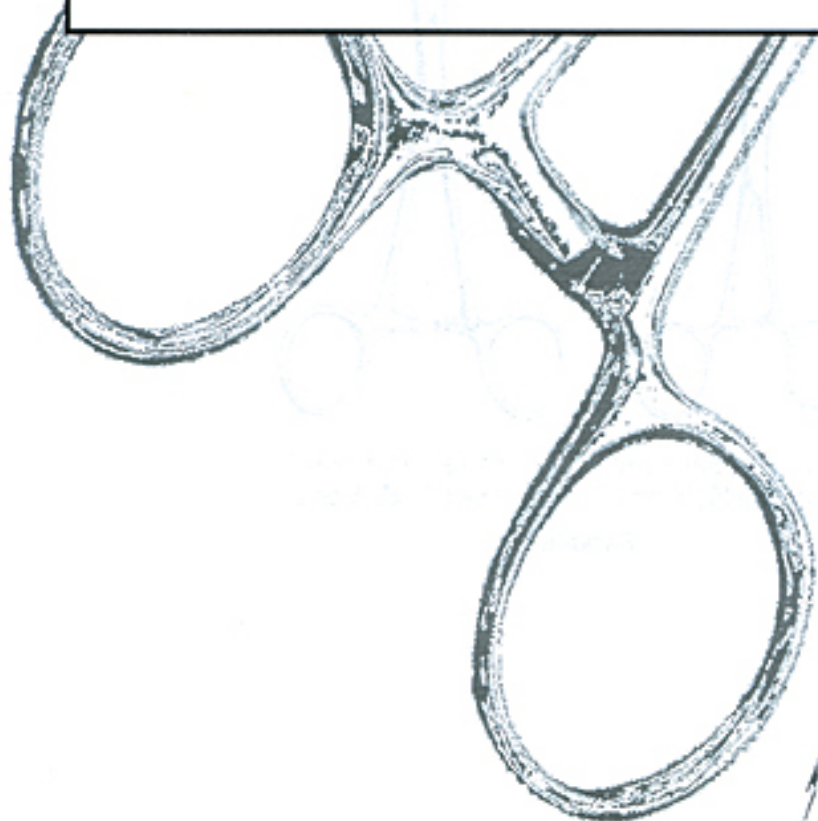
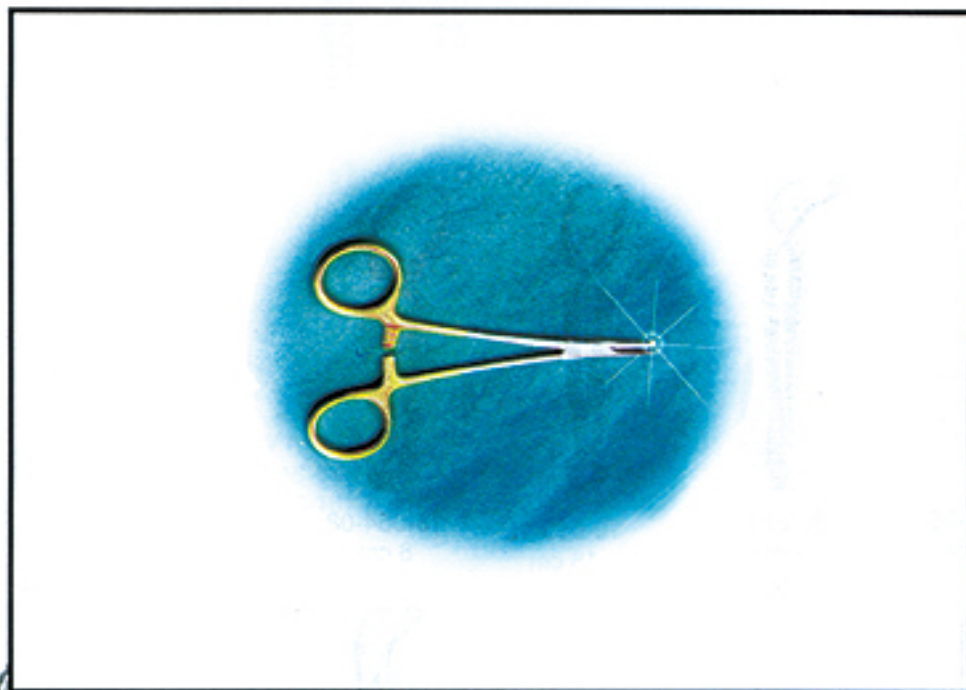

DEPARTMENT NO. 19

FROM
PAGE#

254

TO
PAGE#

265

INSTRUMENTS CATEGORY

NEEDLE HOLDERS
NADEL HOLDERS
PORTA-AGUJAS

NEEDLE HOLDERS
NADEL HALTER
PORTA-AGUJAS

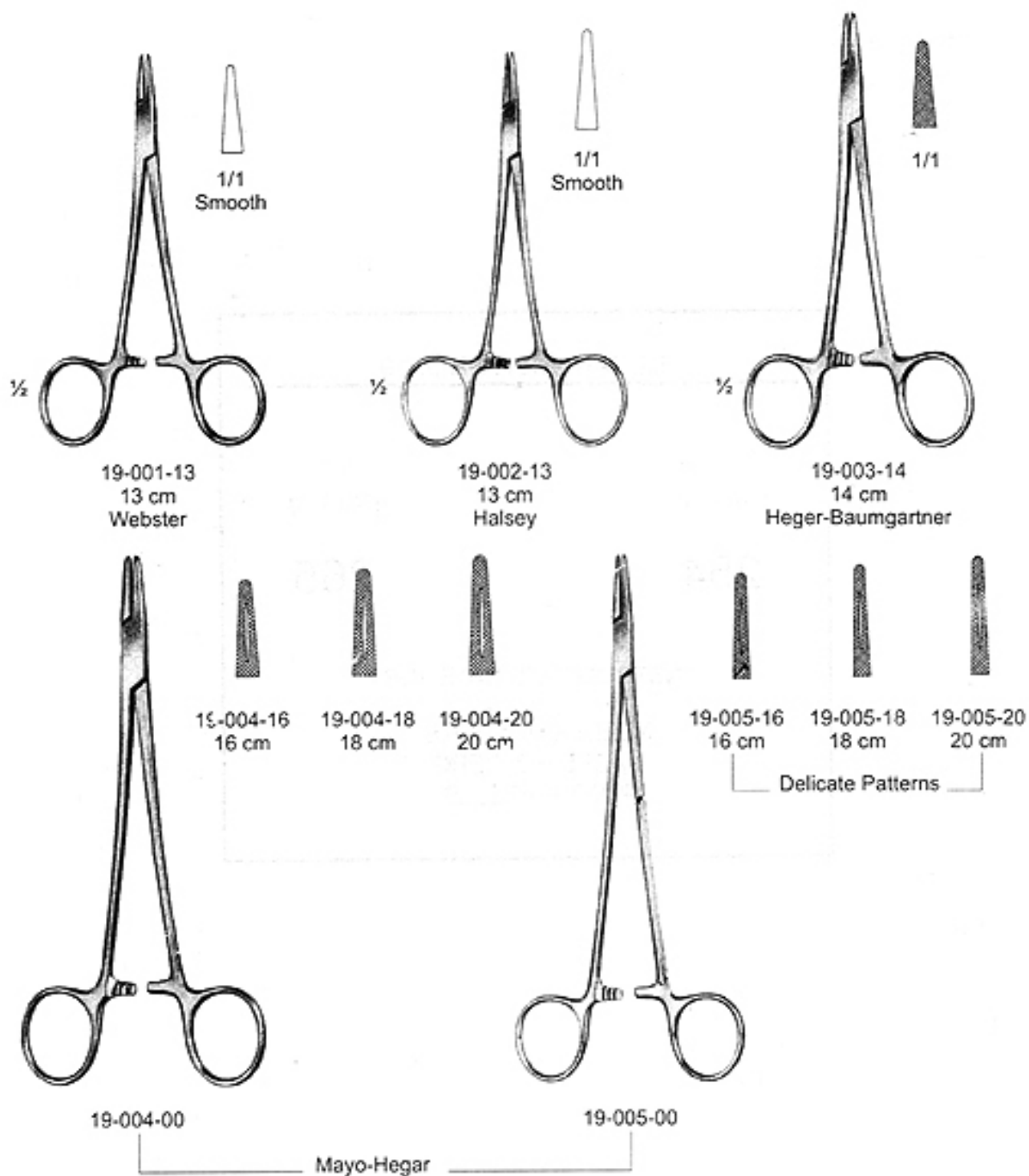





19-007-18
18 cm
Toennis

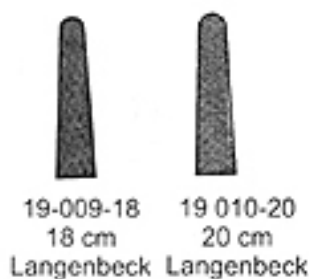

19-008-16
16 cm
Langenbeck



19-011-14(14 cm)
19-012-17(17cm)
Mathieu



19-013-12
12 cm

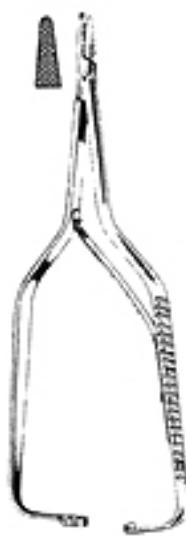

19-014-12
12 cm

Boynton



19-015-14
14 cm
Mathieu

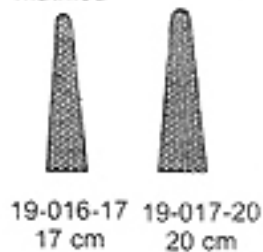

NEEDLE HOLDERS
NADEL HALTER
PORTA-AGUJAS

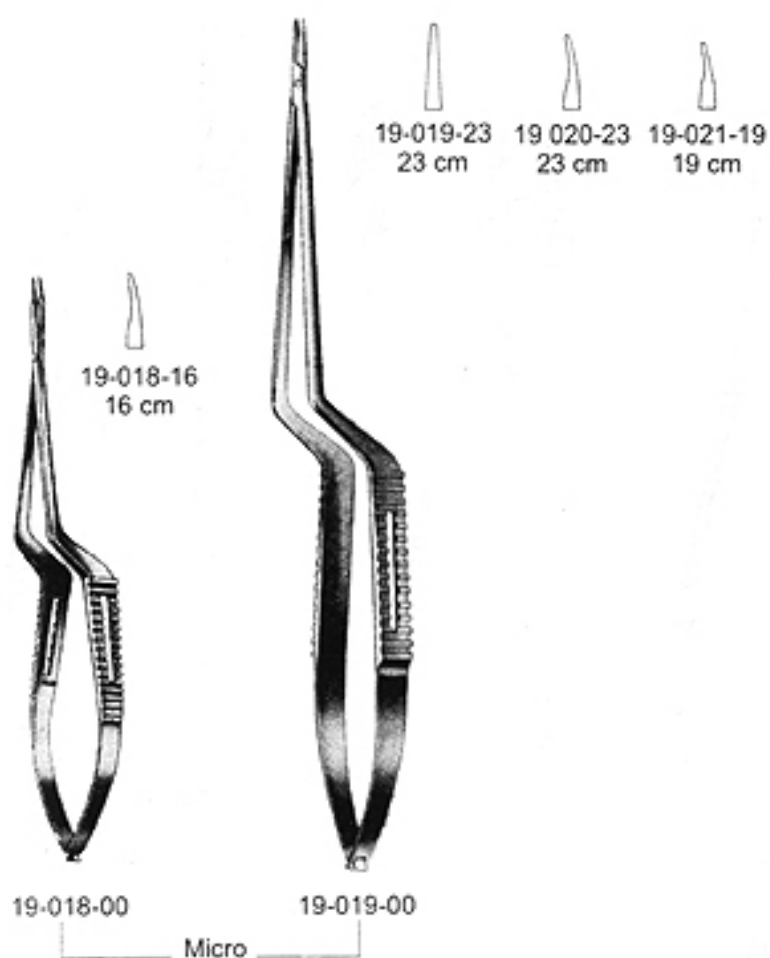

TUNGSTEN CARBIDE INSERTS



19-076-16
16 cm



19-077-16
16 cm



19-078-12
12 cm
Boyton



19-079-14(14 cm)
19-079-17(17 cm)
19-079-20(20 cm)
19-079-24(24 cm)
Mathieu



19-080-00
Langenbeck, Leicht



19-081-16
16 cm



19-082-18
18 cm



19-083-20
20 cm



19-084-22
22 cm



19-085-25
25 cm



19-086-17
17 cm
Lichtenberg



TUNGSTEN CARBIDE INSERTS

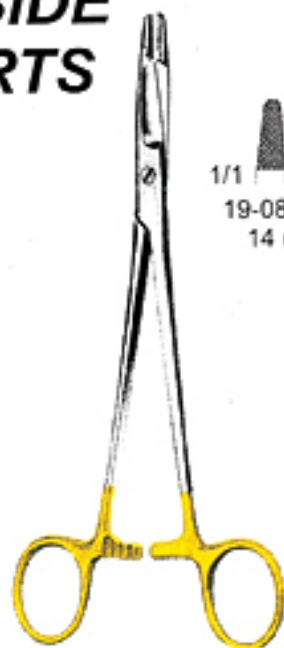

19-087-00
Olsen-Heger

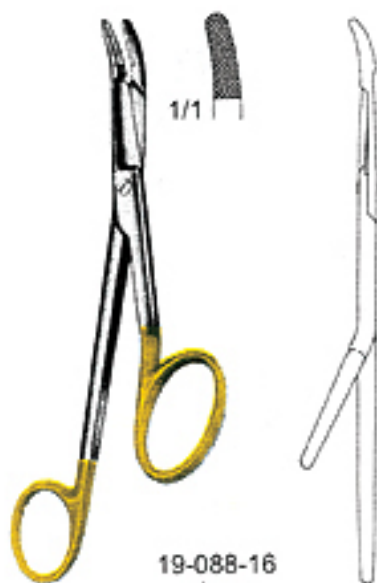

19-088-16
16 cm
Gillies



19-089-15
15 cm

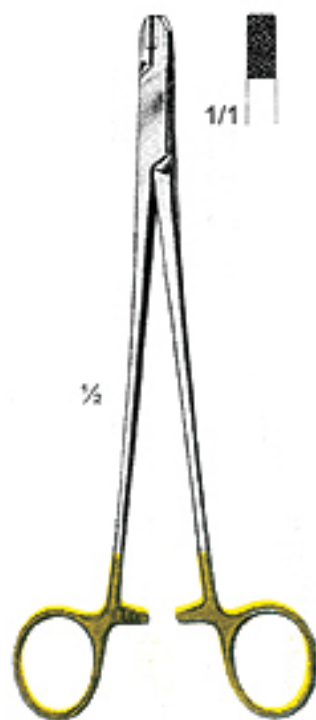

19-090-20
20 cm



TUNGSTEN CARBIDE INSERTS

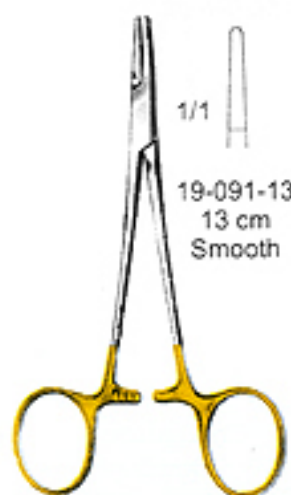

19-091-13
13 cm
Smooth

19-091-13
13 cm
Halsey



19-092-13
13 cm

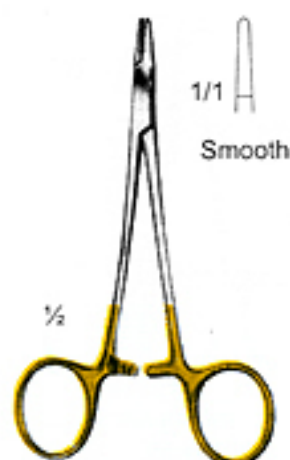

1/1
Smooth

19-093-12
12 cm
Webster



19-094-15
15 cm
Crite Wood

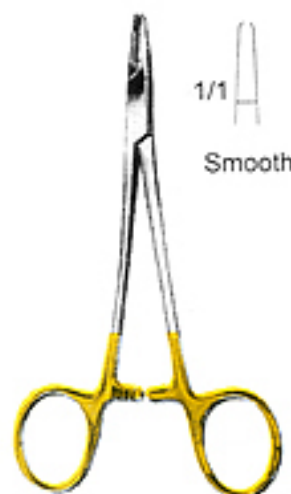

1/1
Smooth

19-095-13
13 cm
Webster



1/1

19-096-12
12 cm
Derf

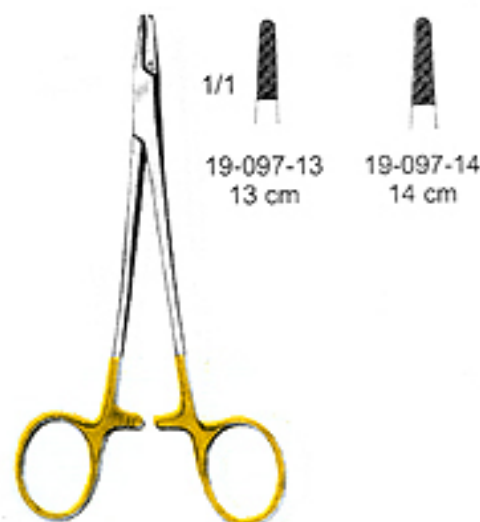

1/1
19-097-13
13 cm

19-097-14
14 cm

19-097-00
Hegar-Baumgartner



TUNGSTEN CARBIDE INSERTS

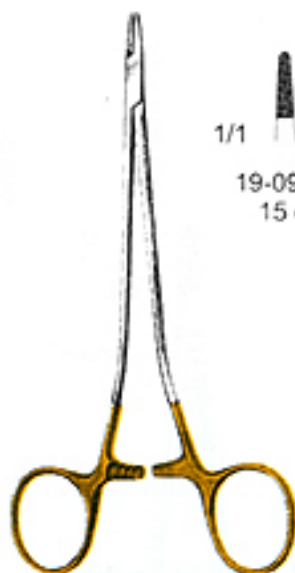

19-098-00
Martin

1/1

19-098-15
15 cm

19-098-17
17 cm

19-098-20
20 cm

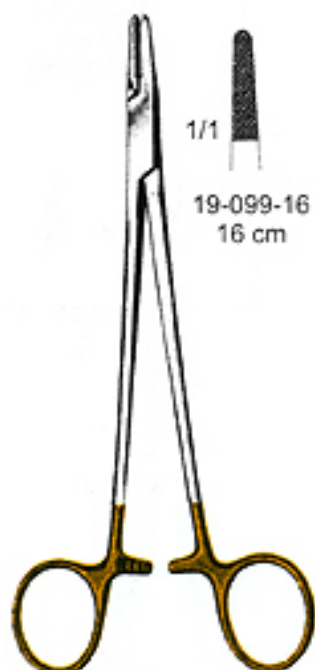

19-099-00
Mayo-Hegar

1/1

19-099-16
16 cm

19-099-18
18 cm

19-099-20
20 cm

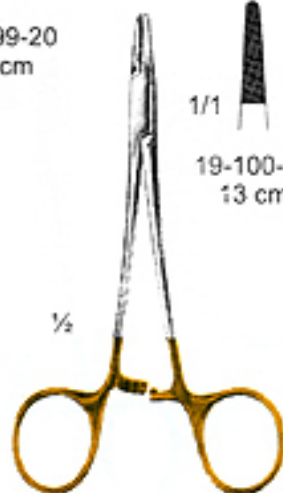

19-100-00
Universal

1/1

19-100-13
13 cm

19-100-15
15 cm

1/2

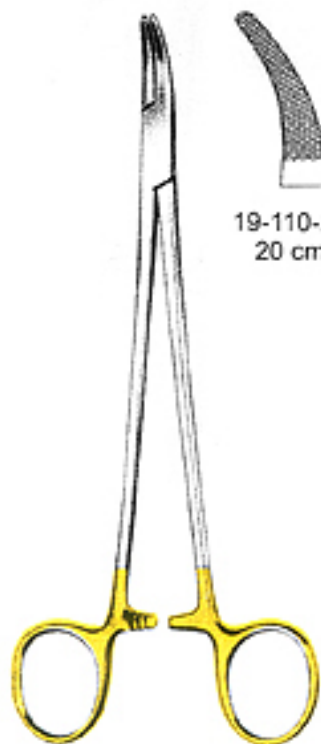
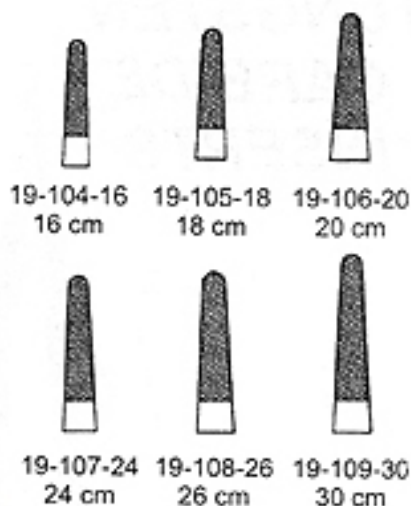
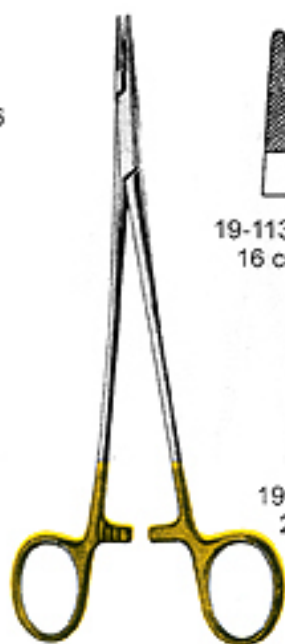
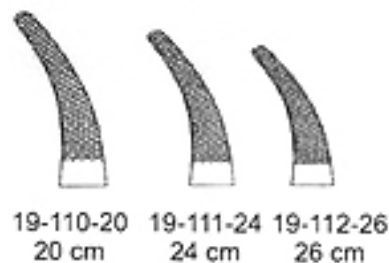
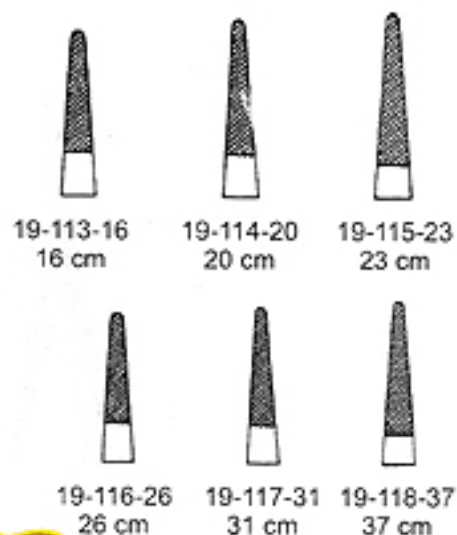
19-101-00
Sarot**TUNGSTEN
CARBIDE
INSERTS**19-104-00
Mayo Heger19-110-00
Mayo Heger (Heaney)19-113-00
De Bakey



TUNGSTEN CARBIDE INSERTS



19-114-00
Vascular



1/1
19-114-18
18 cm



19-115-18
18 cm



19-118-00
Dietrich



1/1
19-118-16
16 cm



19-119-18
18 cm



19-120-20
20 cm



19-121-23
23 cm



19-122-26
26 cm



19-123-00



1/1
19-123-14
14 cm



14-125-14
14 cm



19-127-18
18 cm
Scheidel



1/1
Smooth



19-128-22
22 cm
Pott-Smith

1/1



ARAIN

NEEDLE HOLDERS
NADELHALTER
PORTA-AGUJAS

19

- 1- Probe double end
- 2- Grooved director with tongue tie
- 3- B.P. Handle No.3
- 4- B.P. Handle No.4
- 5- Thum dressing forcep serrated 14 cm
- 6- Tissue forcep 14 cm, 1x2 teeth
- 7- Mayo hegar needle holder 14 cm
- 8- Operating scissor 14 cm SH/BL str
- 9- Operating scissor 14 cm SH/BL cvd

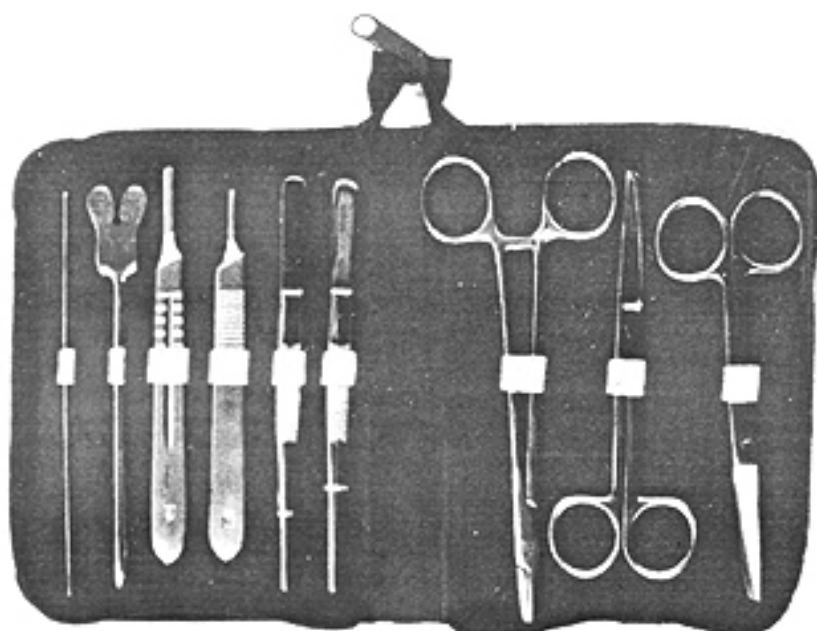

19-134-00
Dissecting set consisting of 9 instruments

- 1- Probe double end
- 2- Grooved director with tongue tie
- 3- B.P. Handle No.3
- 4- B.P. Handle No.4
- 5- Thum dressing forcep serrated 14 cm
- 6- Tissue forcep 14 cm, 1x2 teeth
- 7- Mayo hegar needle holder 14 cm
- 8- Operating scissor 14 cm SH/BL str
- 9- Operating scissor 14 cm SH/BL cvd
- 10- Kelly Forcep 14 cm Str.
- 11- Kelly Forcep 14 cm Cvd.

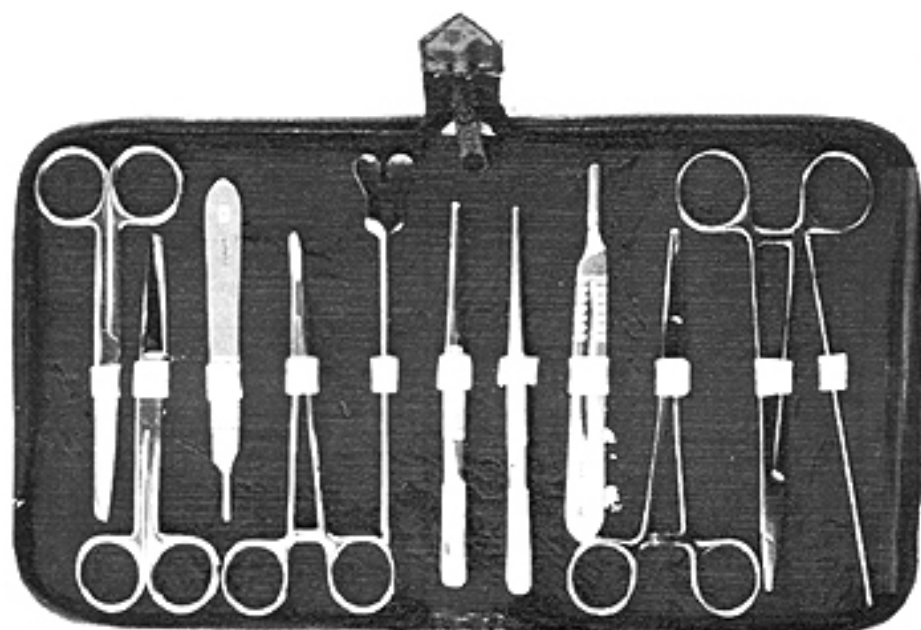

19-134-00
Dissecting set consisting of 11 instruments

Department

20

INSTRUMENTS BOXES
INSTRUMENTENBEHALTER
CONTENEDORES PARA INSTRUMENTOS

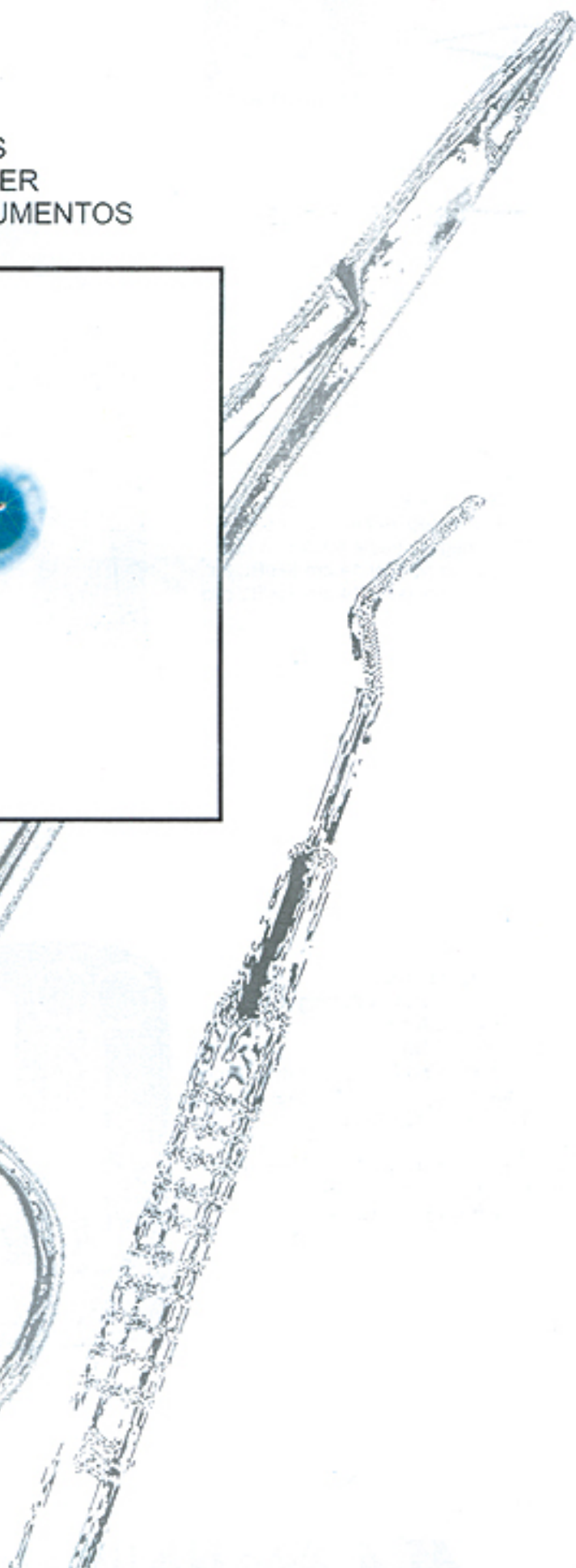
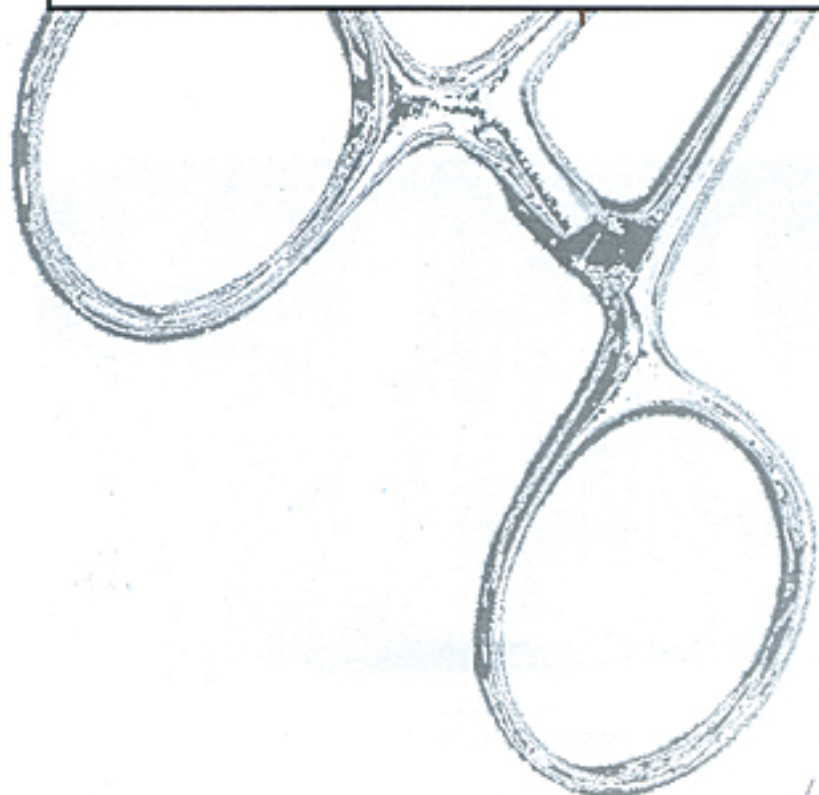
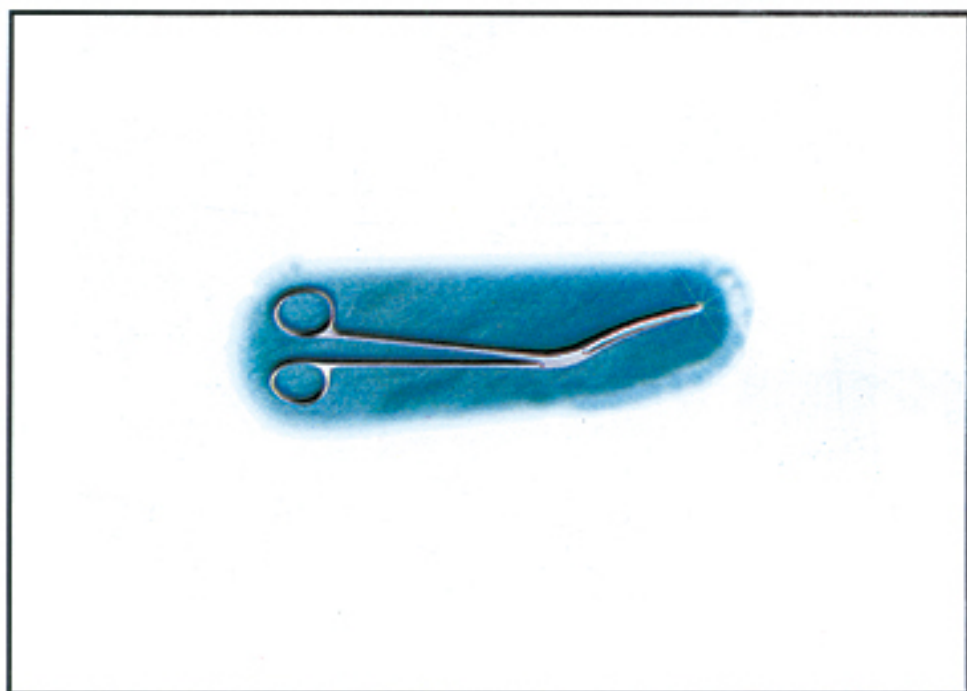

DEPARTMENT NO. 20

FROM
PAGE#

266

TO
PAGE#

272

INSTRUMENTS CATEGORY

INSTRUMENTS BOXES
INSTRUMENTENBEHALTER
CONTENEDORES PARA INSTRUMENTOS

STERILIZER FORCEPS
 STERILISIERZANGEN
 PINZAS PARA ESTERLIZAR

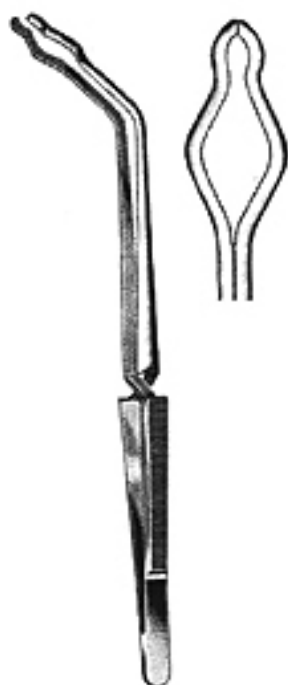
20-001-18(18 cm)
 20-002-25(25 cm)
 Mod . Martin



20-003-16(16 cm)
 20-004-20(20 cm)
 20-005-24(24 cm)
 Davis



20-006-25(25 cm)
 20-007-30(30 cm)
 Pye-Smith
 (Harrison)



20-008-23
 23 cm
 Rogge



20-009-20(20 cm)
 20-010-30(30 cm)



20-011-27
 27 cm
 Cheatle



STERILIZER FORCEPS
STERILISIERZANGEN
PINZAS PARA ESTERLIZAR

20



20-012-24
24 CM



20-013-24
24 CM
Ulival



20-014-20(20 cm)
20-015-28(28 cm)



20-016-20(20 cm)
20-017-28(28 cm)

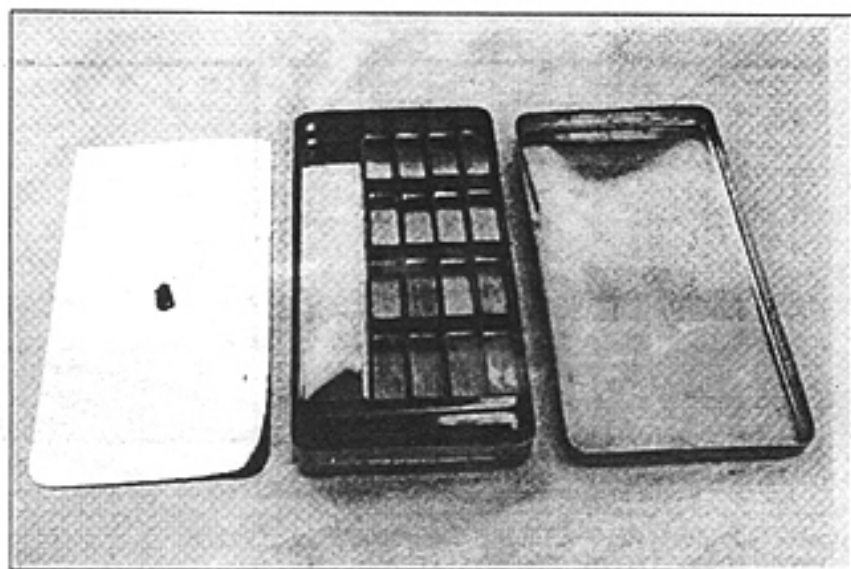

20-018-00
Endodontics Try
Curettage Case Double Cap

**INSTRUMENTS BOXES
INSTRUMENTENBEHALTER
CONTENEDORES PARA INSTRUMENTOS**



L	W	H
20-066-00	(17x7x3 cm)	
20-067-00	(17.5x7.5x3 cm)	
20-068-00	(18x6x3 cm)	
20-069-00	(18x7x3 cm)	
20-070-00	(18x9x4 cm)	
20-071-00	(20x10x4 cm)	
20-072-00	(21x10x4 cm)	

Instrument Boxes
In Different Sizes.

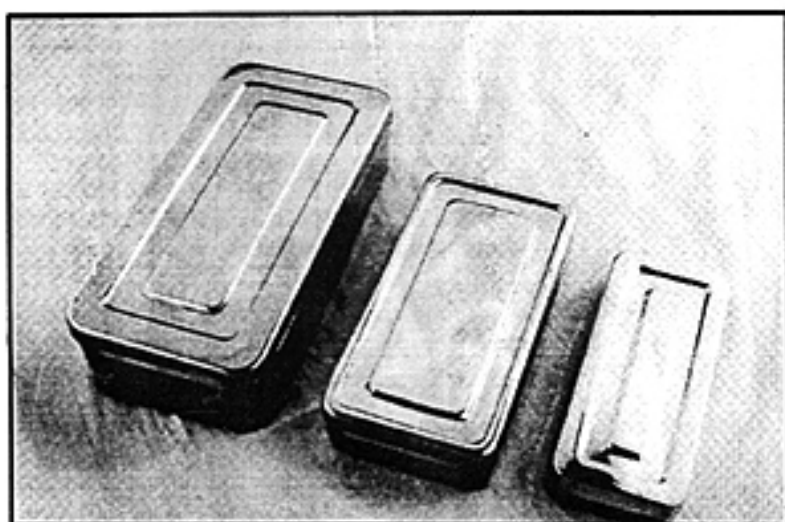

20-073-00
Needle Case

20-074-00(5 cc)
20-075-00(2 cc)
Syringe Case



20-076-0
Finger Cup

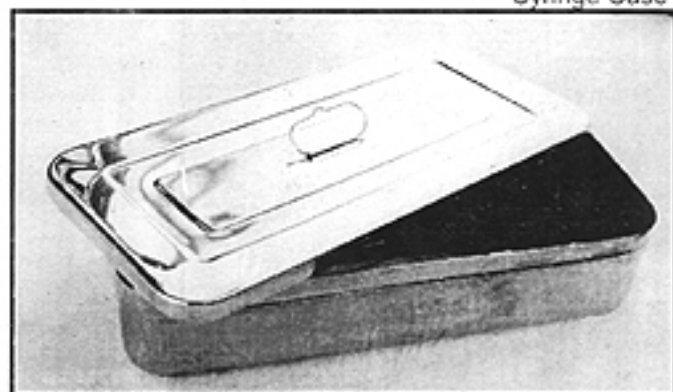

L	W	H	L	W	H
20-077-00	(30x15x10 cm)		20-083-00	(40x20x10 cm)	
20-078-00	(30x17x5 cm)		20-084-00	(40x30x5 cm)	
20-079-00	(34x16x5 cm)		20-085-00	(40x30x10 cm)	
20-080-00	(36x24x5 cm)		20-086-00	(42x19x5 cm)	
20-081-00	(36x24x10 cm)		20-087-00	(45x30x5 cm)	
20-082-00	(40x20x5 cm)		20-088-00	(45x30x10 cm)	

Instrument Boxes
In Different Sizes.

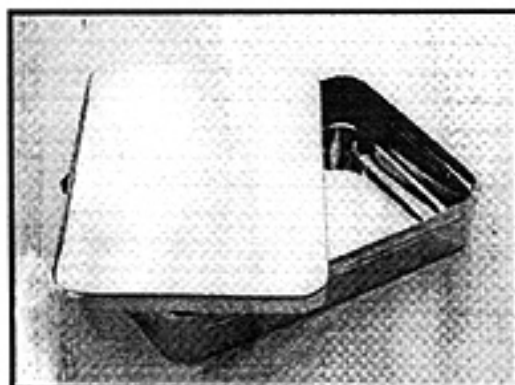

L	W	H
20-089-00	(23x15x5 cm)	
20-090-00	(25x12x5 cm)	
20-091-00	(25x12x10 cm)	
20-092-00	(26x15x5 cm)	
20-093-00	(30x15x5 cm)	
20-094-00	(32x8x4 cm)	

Instrument Boxes
In Different Sizes.



STERILIZING/DRESSING DRUM
 STERILISING/PRAPARIERTROMMEL
 TAMBOR PARA ESTERILIZACION Y PREPARACION

20

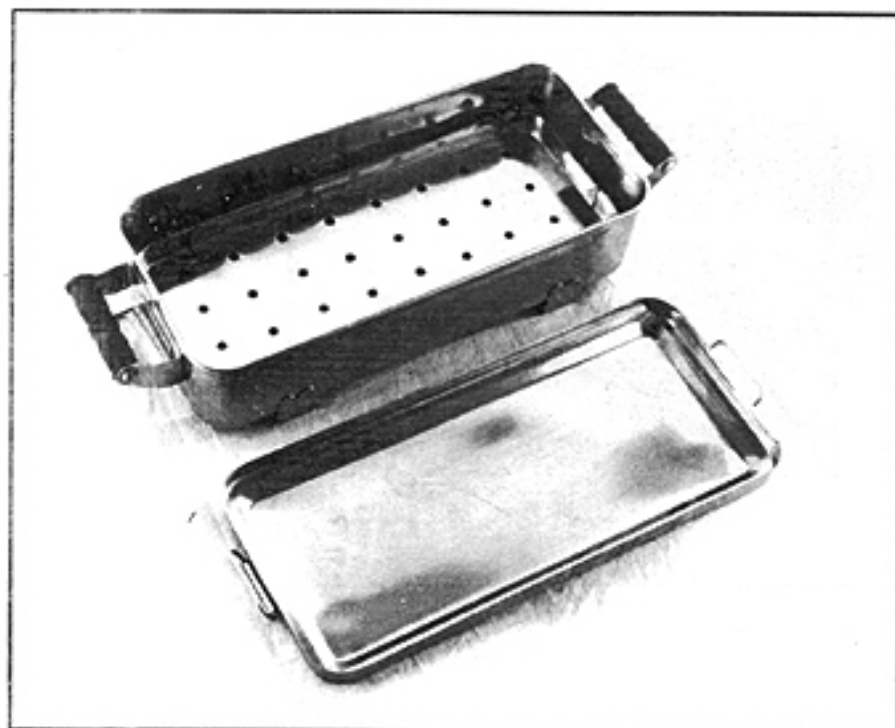

20-095-00(27x12x6 cm)
 Sterilizer With Heater



- | | |
|----------------------|----------------------|
| 20-096-00 (24x12 cm) | 20-101-00 (34x28 cm) |
| 20-097-00 (30x15 cm) | 20-102-00 (37x30 cm) |
| 20-098-00 (30x30 cm) | 20-103-00 (39x14 cm) |
| 20-099-00 (34x16 cm) | 20-104-00 (39x20 cm) |
| 20-100-00 (34x24 cm) | 20-105-00 (39x29 cm) |

Dressing/Sterilizing Drum
 In Different Sizes.

- 20-106-00 (8x8 cm)
- 20-107-00 (10x10 cm)
- 20-108-00 (12x12 cm)
- 20-109-00 (15x15 cm)
- 20-110-00 (16x12 cm)
- 20-111-00 (18x18 cm)
- 20-112-00 (19x14 cm)
- 20-113-00 (19x20 cm)
- 20-114-00 (20x16 cm)
- 20-115-00 (20x20 cm)
- 20-116-00 (24x16 cm)
- 20-117-00 (24x24 cm)
- 20-118-00 (29x14 cm)
- 20-119-00 (29x16 cm)
- 20-120-00 (29x24 cm)

Dressing/Sterilizing Drum
 In different sizes.

STERILIZING, DRESSING JAR & FORCEPS
 STERILISING, PRAPARIERBEHALTER, ZANGENBEHALTER
 CAJA PARA ESTERILIZACION Y PREPARACION CAJA PARA PINZAS

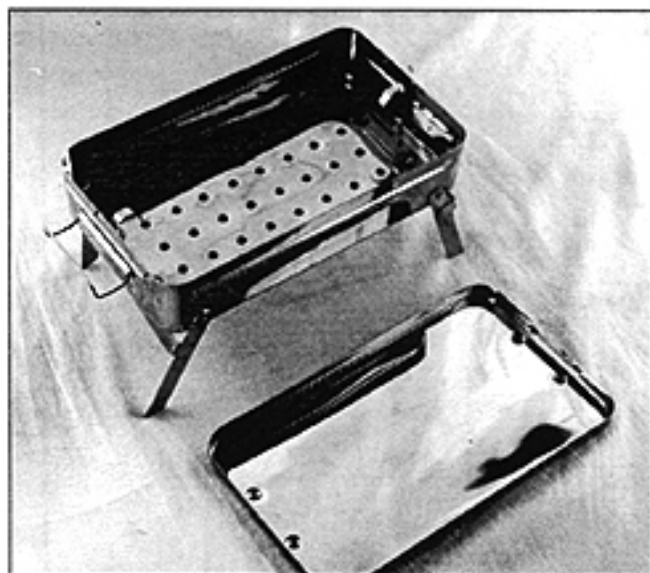

20-121-00 (20x10x5 cm)
 20-122-00 (25x12x5 cm)
 20-123-00 (26x15x5 cm)

Boiling Sterilizer With
 Perforated Tray Stand
 And Lifter.



20-124-00 (7.5x7.5 cm) 20-128-00 (18x18 cm)
 20-125-00 (10x10 cm) 20-129-00 (10x12.5 cm)
 20-126-00 (12.5x12.5 cm) 20-130-00 (20x20 cm)
 20-127-00 (15x15 cm)

Cotton/Dressing Jar
 With Lid. Consisting of
 Different Sizes.

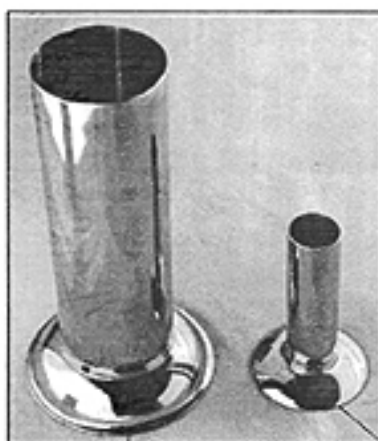

20-131-00 (5x11.5 cm)
 20-132-00 (5x16.5 cm)

20-133-00 (3x11 cm)
 20-133-00
 Thermometer Jar.

Forcep Jar/Cheattle Jar
 Consisting Of Different
 Sizes.

Department

21

RUBBER DAM INSTRUMENTS
KOFFERDAM - INSTRUMENTE
INSTRUMENTOS PARA DIQUE DE GOMA

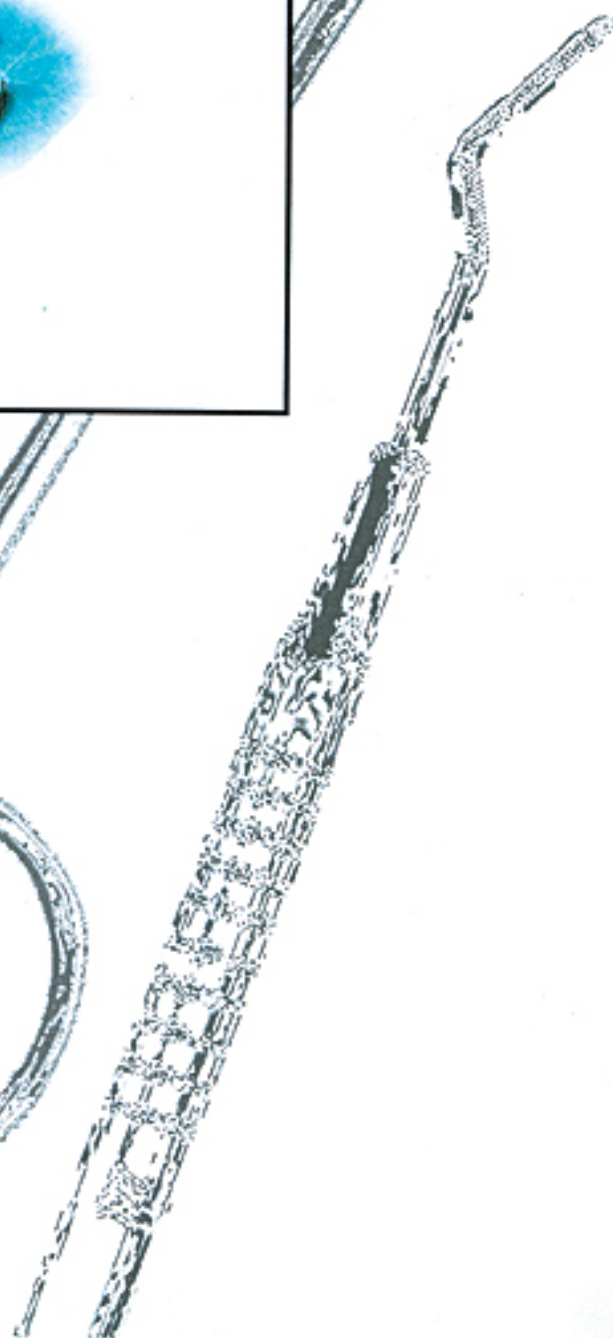
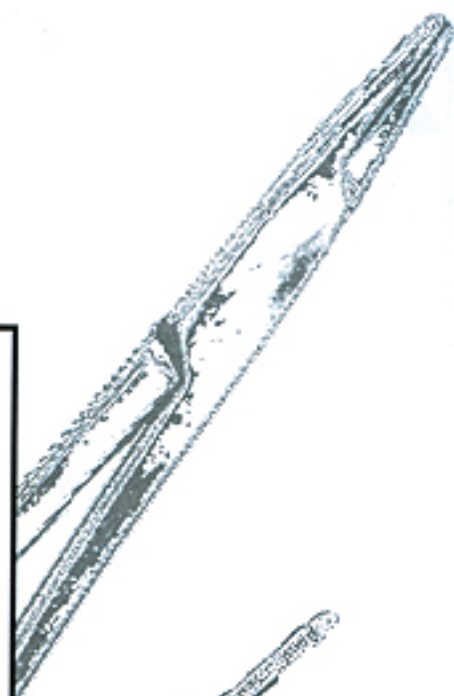
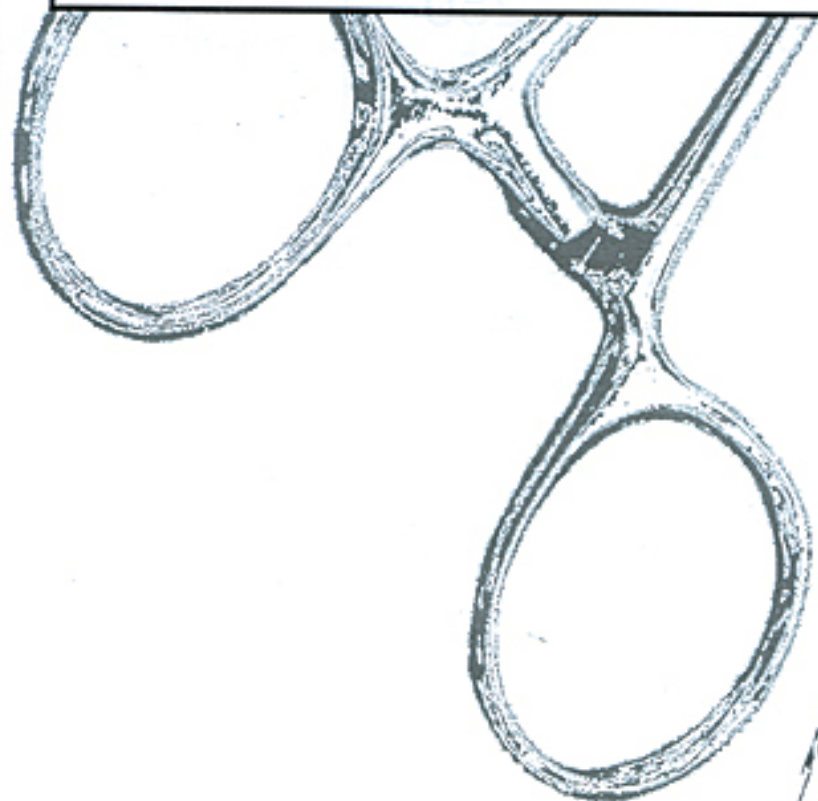
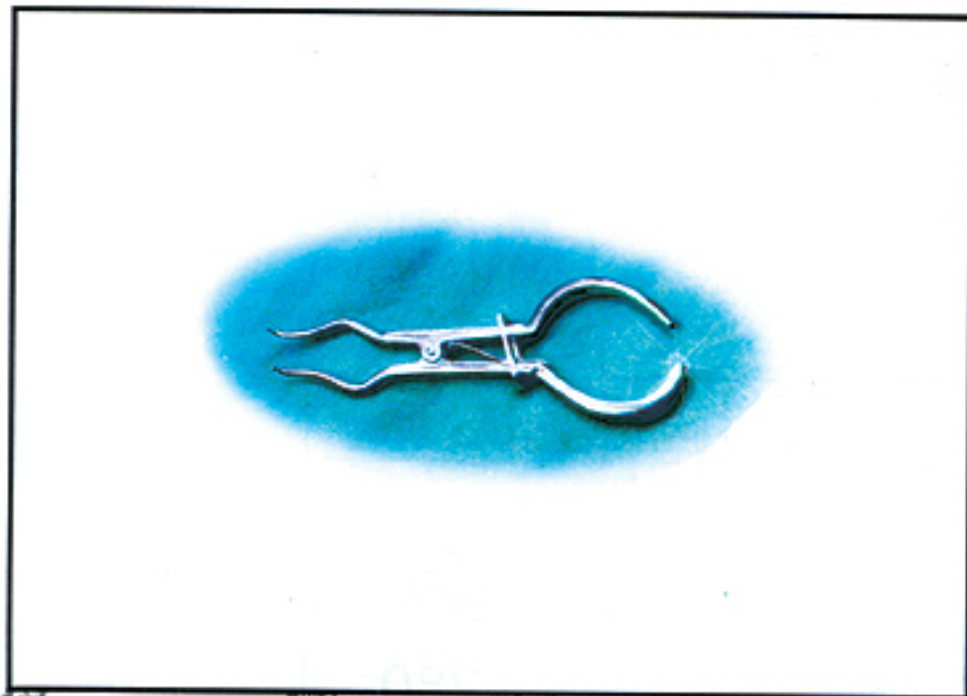

DEPARTMENT NO. 21

FROM
PAGE#

273

TO
PAGE#

280

INSTRUMENTS CATEGORY

RUBBER DAM INSTRUMENTS
KOFFERDAM - INSTRUMENTE
INSTRUMENTOS PARA DIQUE DE GOMA



ARAIN

RUBBER DAM INSTRUMENTS
KOFFERDAM - INSTRUMENTE
INSTRUMENTOS PARA DIQUE DE GOMA

21

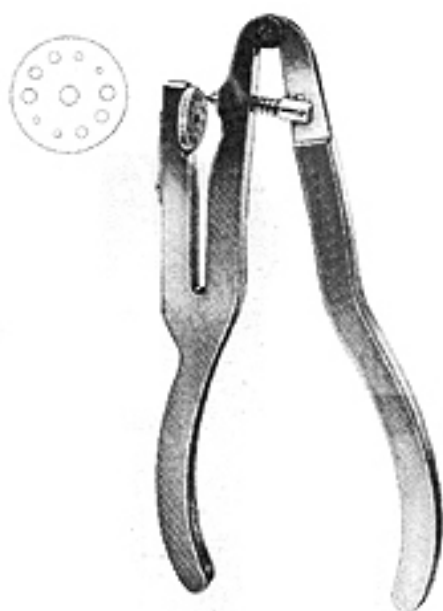

21-001-00
Ivory
With two rows of holes

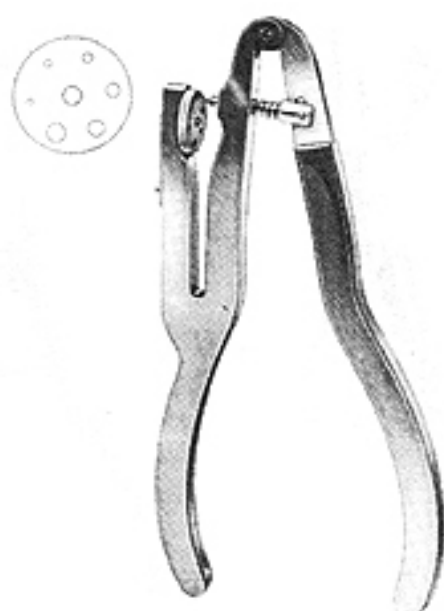

21-002-00
Ivory
With one rows of holes



21-003-00



21-004-00

Ainsworth

M. A. ARAIN & BROTHERS (PVT.) LTD.

275



5
 21-005-00
 Ainsworth type rubber
 dam punch



21-006-00



21-007-00
 Light weight rubber
 dam punch



21-008-17
 17 cm
 Ainsworth

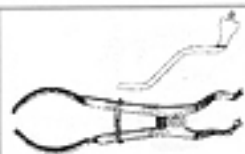

RUBBER DAM INSTRUMENTS
 KOFFEER DAM - INSTRUMENTE
 INSTRUMENTOS PARA DIQUE DE GOMA

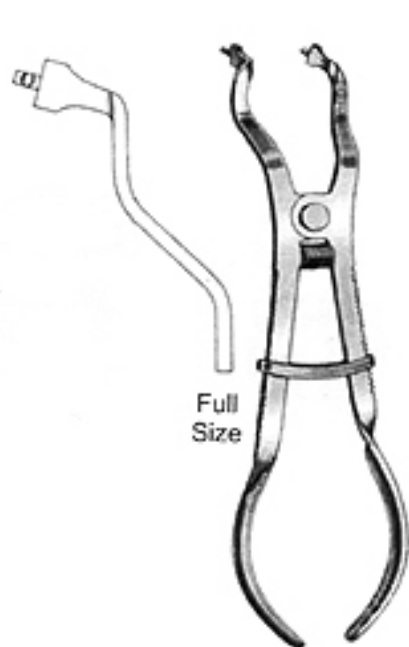

21-009-00
Ivory

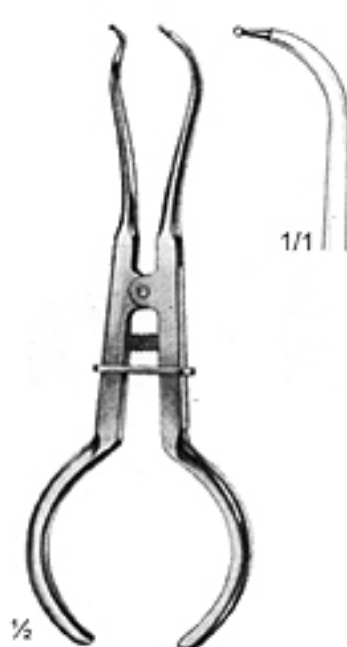

21-010-00
White

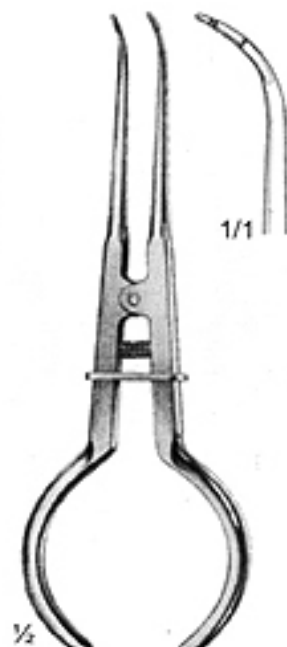

21-011-00
Palmer

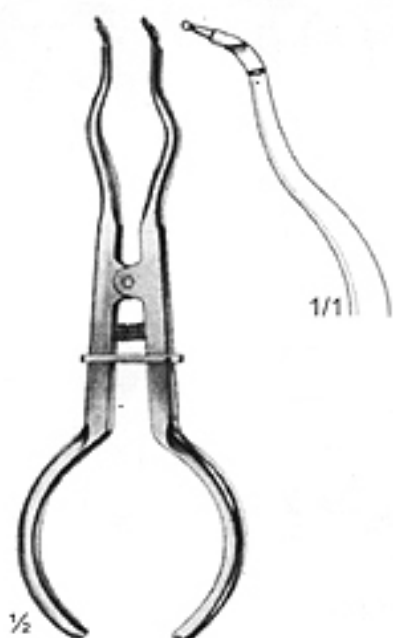

21-012-00
Brewer

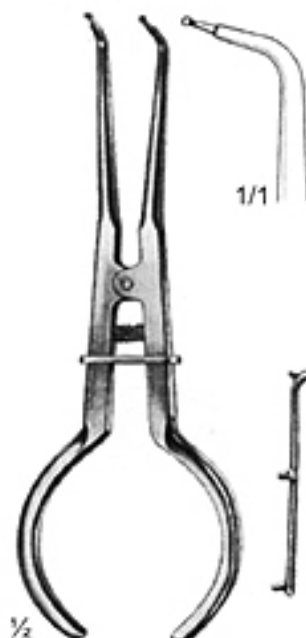

21-013-00
Stockes

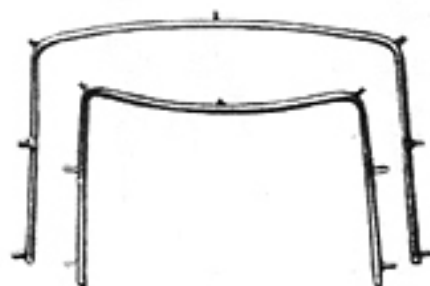

21-014-00 (Large)
21-015-00 (Small)
Rubber Dam Frame

RUBBER DAM CLAMPS
KOFFERDAM - CLAMMERNS
CLAMPS PARA DIQUE



201
21-016-00



202
21-017-00



203
21-018-00



204
21-019-00



205
21-020-00



3
21-021-00



4
21-022-00



5
21-023-00



8
21-024-00



8A
21-025-00



12A
21-026-00



13A
21-027-00



14
21-028-00



14A
21-029-00



200
21-030-00



ARAIN

RUBBER DAM CLAMPS
KOFFERDAM - CLAMMERNS
CLAMPS PARA DIQUE

21



24
21-031-00



25
21-032-00



26
21-033-00



28
21-034-00



30
21-035-00



51
21-036-00



138
21-037-00



139
21-038-00



31
21-039-00



W8A
21-040-00



W14
21-041-00



W14A
21-042-00



15
21-043-00



18
21-044-00

RUBBER DAM CLAMPS
KOFFERDAM - CLAMMERNS
CLAMPS PARA DIQUE



212
21-045-00



22
21-046-00



27
21-047-00



29
21-048-00



210
21-049-00



211
21-050-00



21-051-00



206
21-052-00



207
21-053-00



208
21-054-00



209
21-055-00



00
21-062-00



0
21-059-00



1
21-057-00



W2
21-058-00



W3
21-056-00



W13
21-063-00



2A
21-060-00



9
21-064-00



26N
21-061-00



2
21-065-00



7
21-066-00



7A
21-067-00



12
21-068-00



17N
21-069-00



56
21-070-00



60
21-071-00

Department

22

CROWN INSTRUMENTS
KRONENINSTRUMENTE
INSTRUMENTOS PARA CORONAS

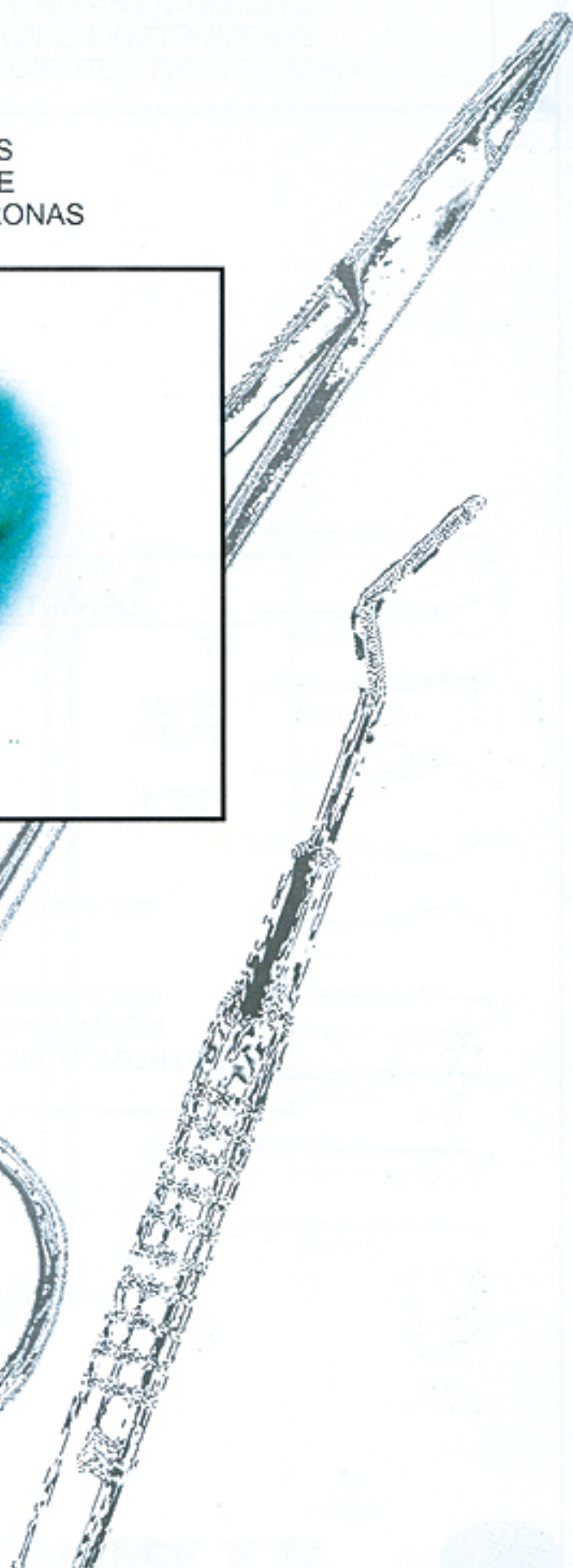
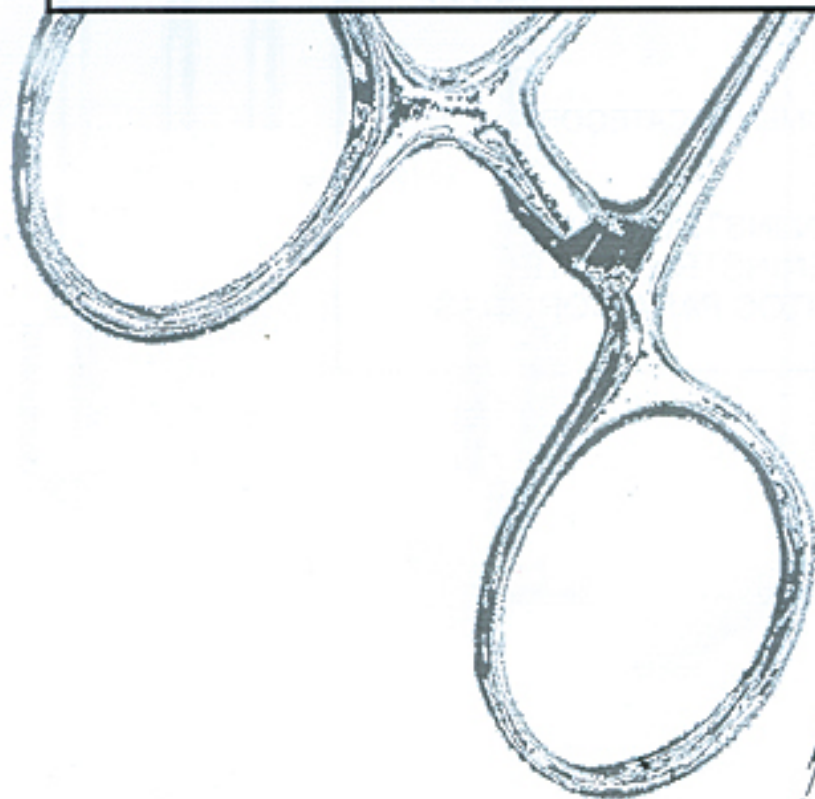
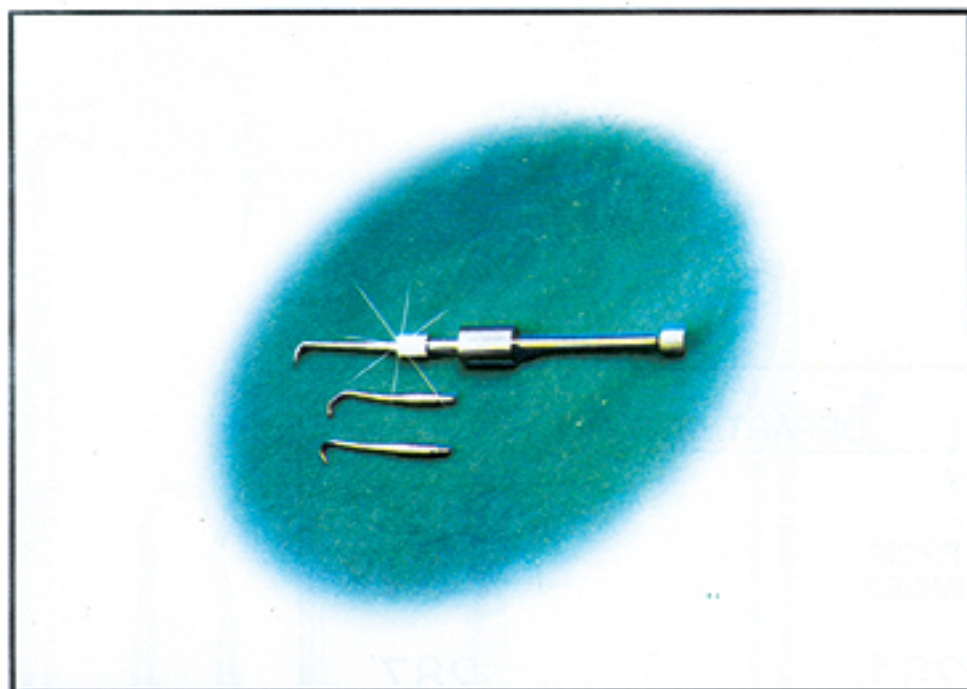

DEPARTMENT NO. 22

FROM
PAGE#

281

TO
PAGE#

287

INSTRUMENTS CATEGORY

CROWN INSTRUMENTS
KRONENINSTRUMENTE
INSTRUMENTOS PARA CORONAS



CROWN INSTRUMENTS
KRONEN INSTRUMENTE
INSTROUMENTOS PARA CORONAS

22



1-3
22-001-00

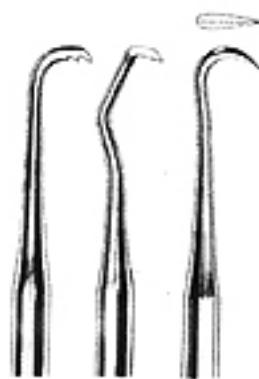

1 2 3
22-001-01 22-001-02 22-001-03



1-3
22-002-00



0-9
22-003-00

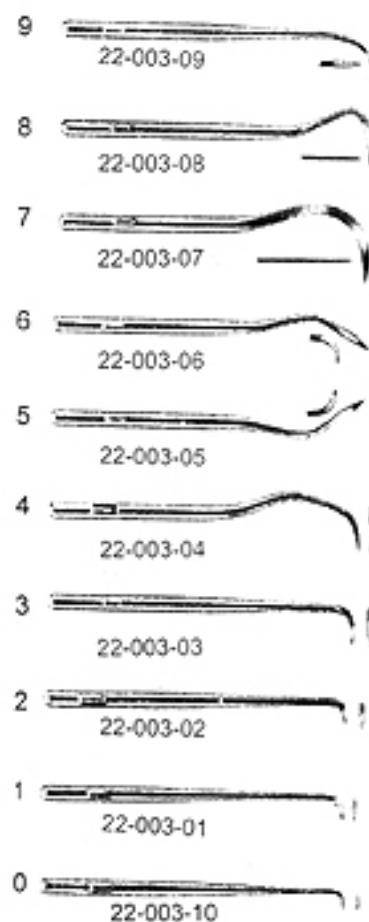

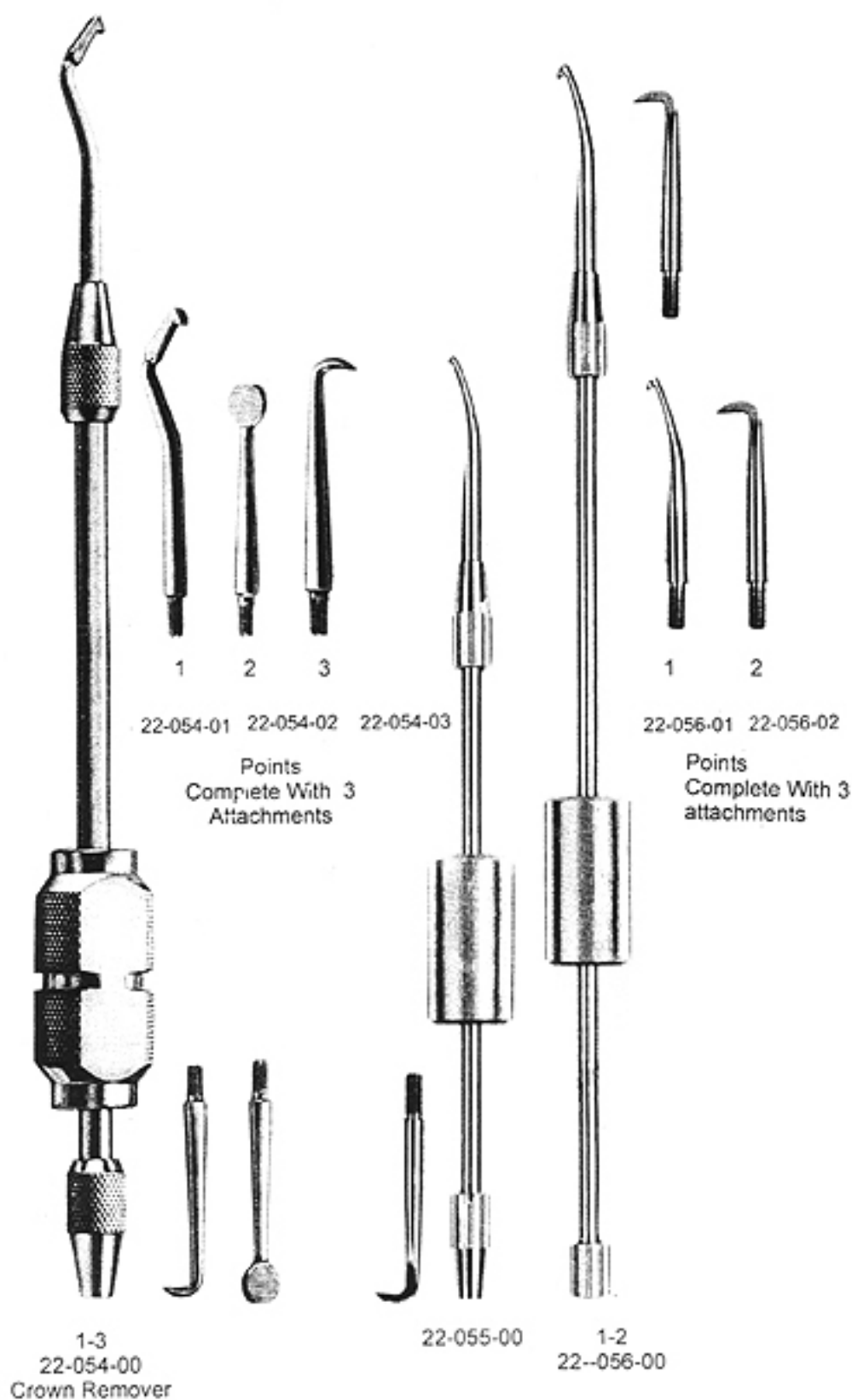



CROWN INSTRUMENTS
KRONEN INSTRUMENTE
INSTRUMENTOS PARA CORONAS

22



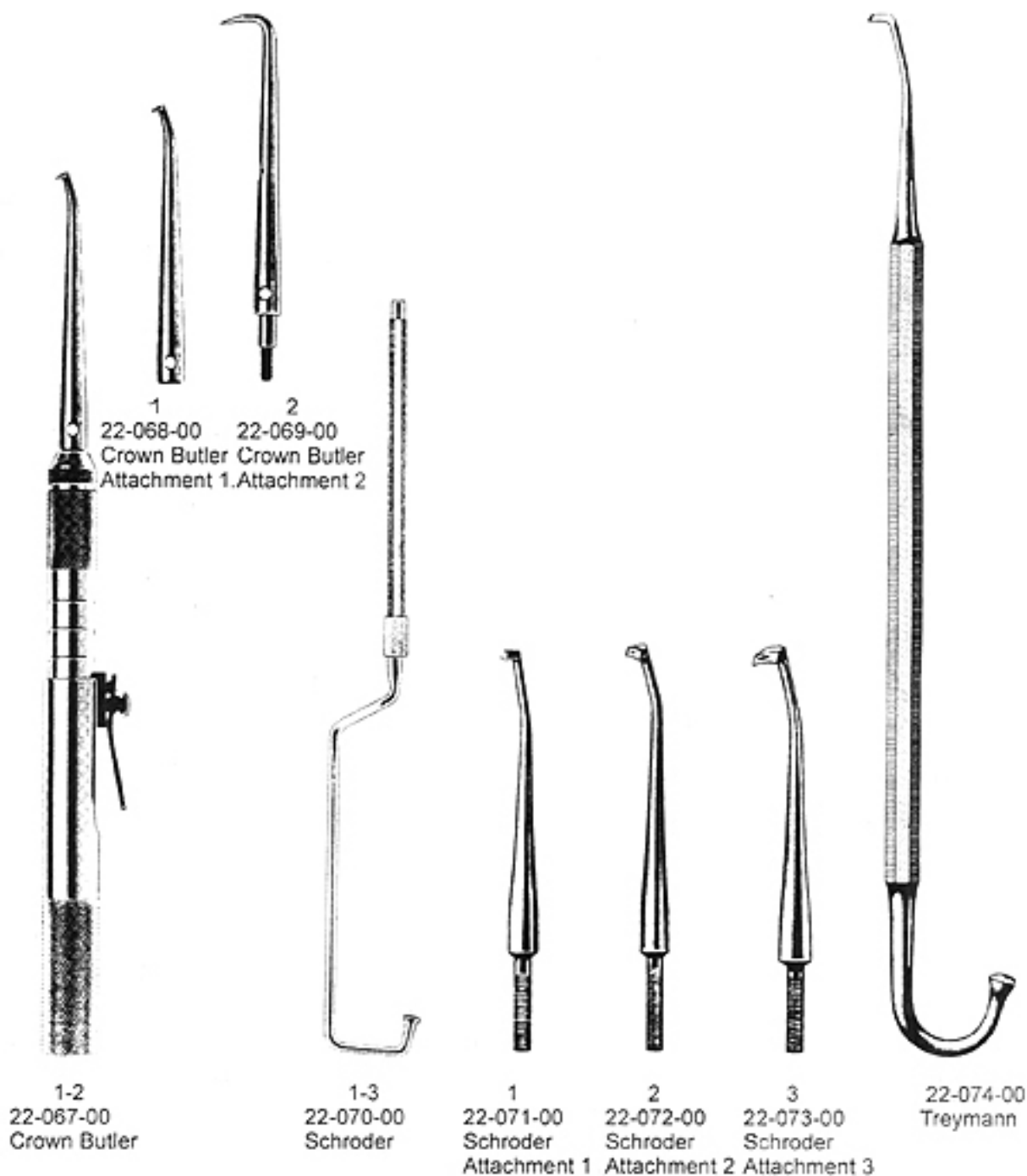



1-3
22-076-00



Crown
Removing Forcep
17 cm
22-078-17

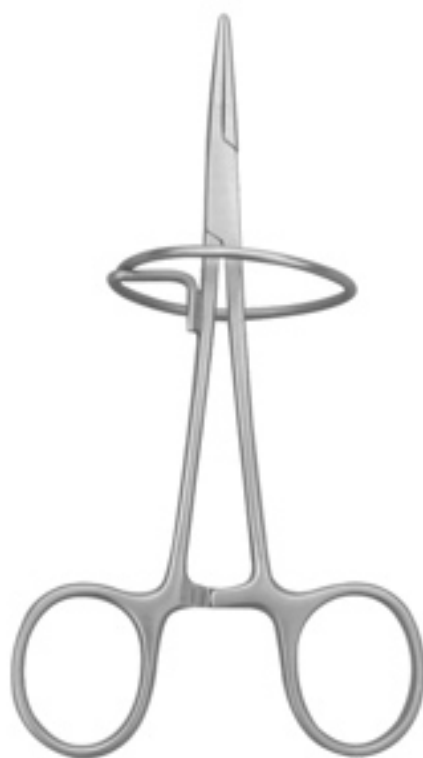

22-097-00

Crown & Bridge Holding Forceps with support Ring
22-096-00



SUCTION TUBES
SAUGROHRE
TUBOS DE ASPIRACION

22



Ligature Instrument
22-098-00



Saliva Ejectors
22-099-00 Ø 3 mm
22-100-00 Ø 4 mm
22-101-00 Ø 5 mm
18 cm

AMALGAM CARRIERS
AMALGAMPISTOLEN
PORTA AMALGAMAS

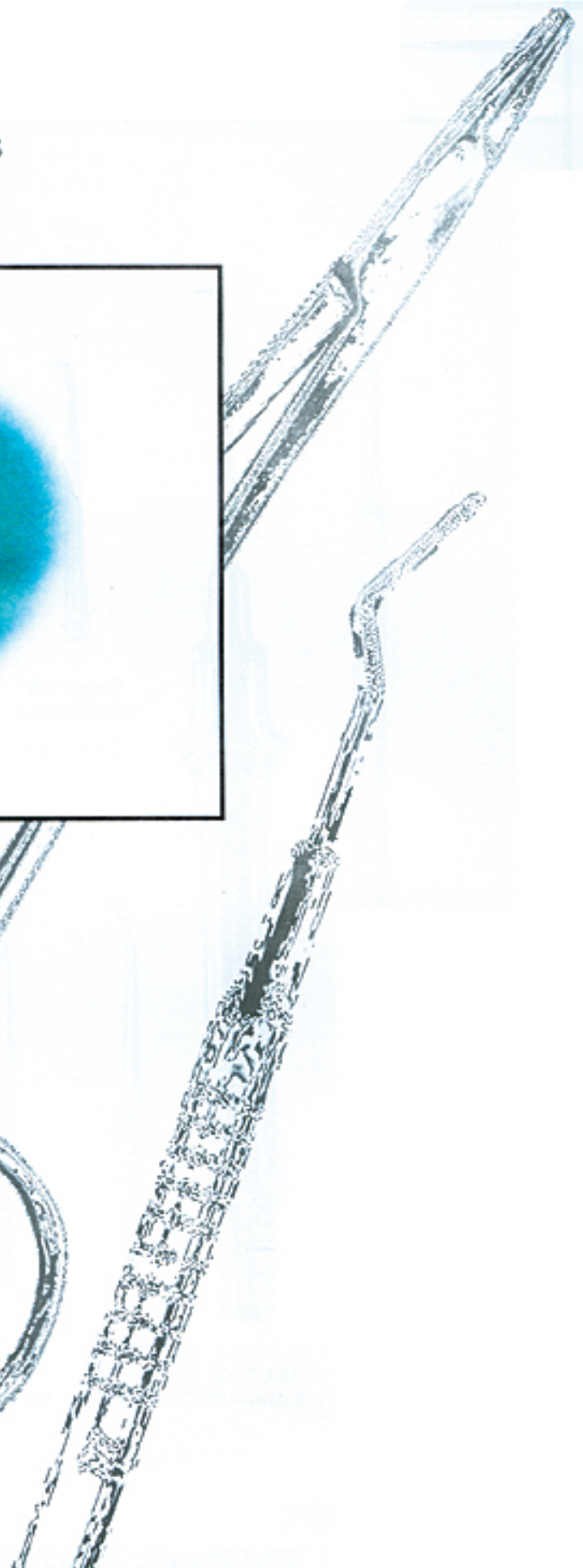
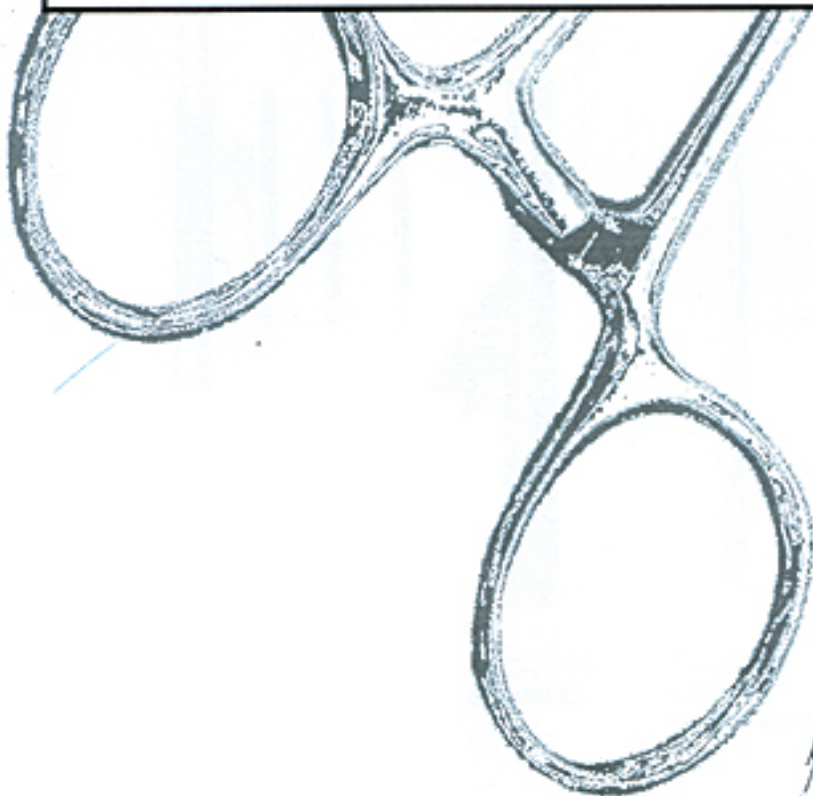
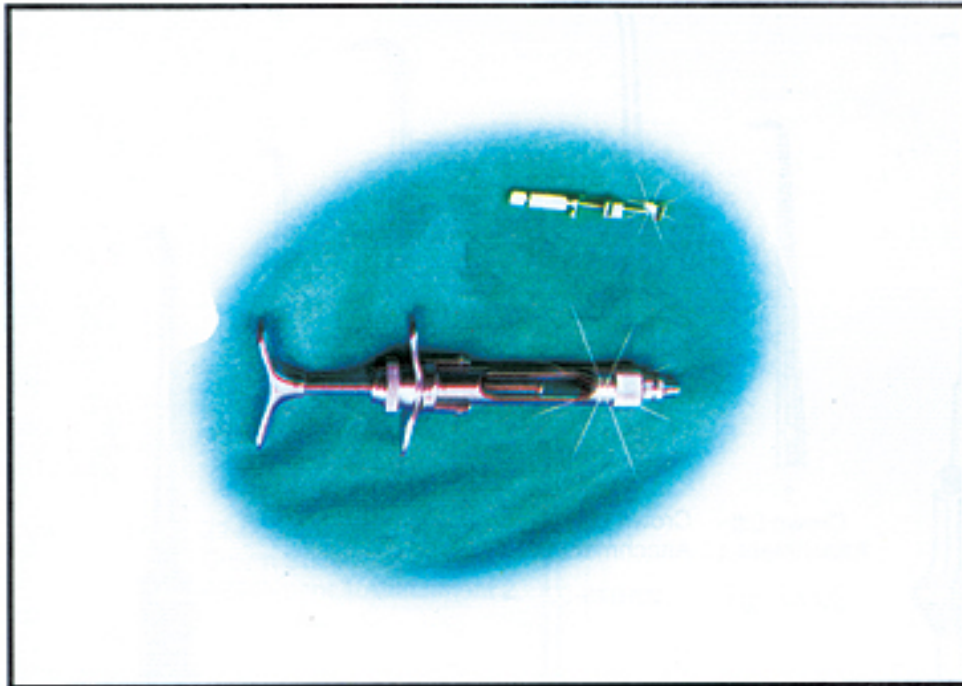

DEPARTMENT NO. 23

FROM
PAGE#

288

TO
PAGE#

295

INSTRUMENTS CATEGORY

AMALGAM CARRIERS
AMALGAMPISTOLEN
PORTA AMALGAMAS

AMALGAM CARRIERS
AMALGAMPISTOLEN
PORTA AMALGAMAS



23-001-00
Non-Slip
Amalgam Well



23-002-00
Amalgam Well



1/1

23-004-00

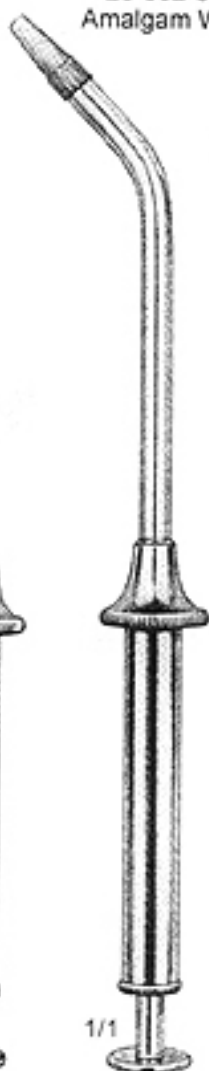

1/1

23-005-00

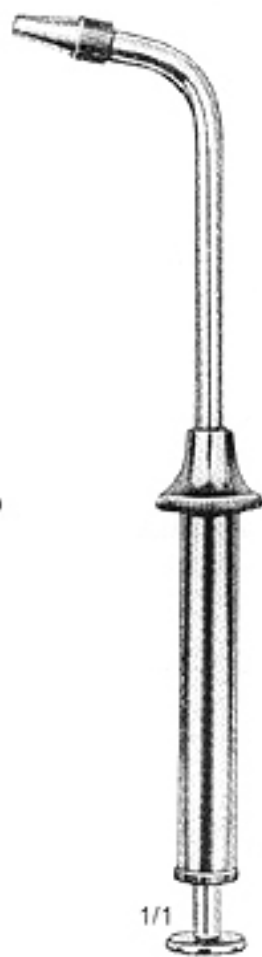

1/1

23-006-00

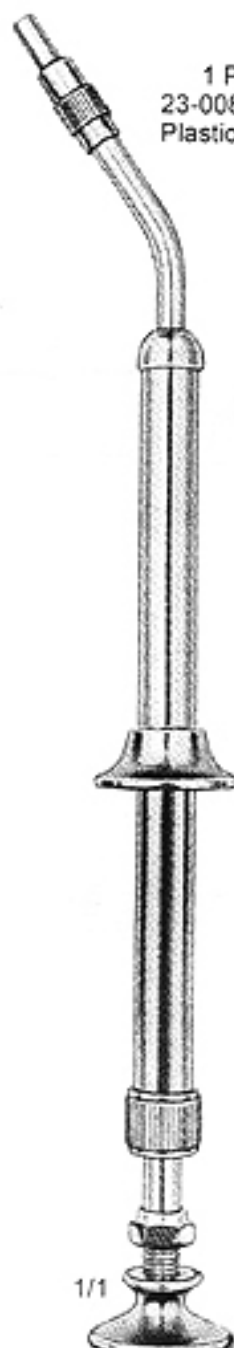

1/1

23-007-00

1 P
23-008-00
Plastic Tip



2 P
23-009-00
Metal Tip



3
23-010-00
Metal Tip
For 23-007-00



3
23-011-00
Plastic Tip
For 23-007-00



23-003-00
Micro



AMALGAM CARRIERS
AMALGAMPISTOLEN
PORTA AMALGAMAS

23

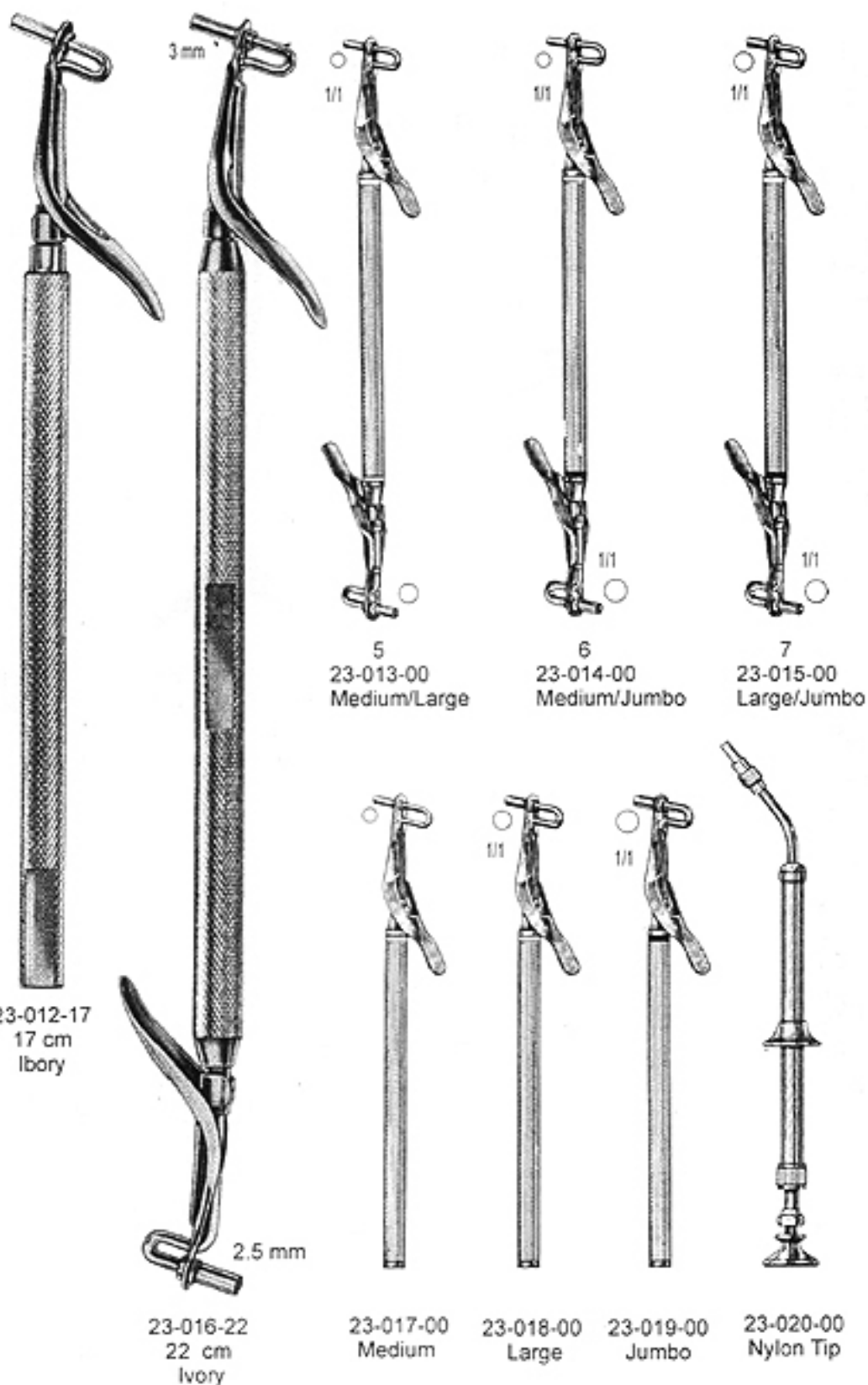

CARTRIDGE SYRINGES
INJEKTIONSKANULEN
JERINGAS PARA CARTUCHO

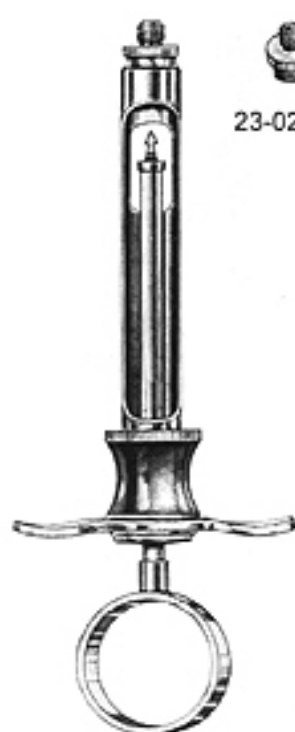
23-023-00



23-026-00



23-031-00

23-032-00

23-021-00 (1.8 ml)
23-022-00 (2.2 ml)

23-024-00 (1.8 ml)
23-025-00 (2.2 ml)

23-027-00 (1.8 ml)
23-028-00 (2.2 ml)

23-029-00 (1.8 ml)
23-030-00 (2.2 ml)



23-033-00 (1.8 ml)
23-034-00 (2.2 ml)



23-035-00 (1.8 ml)
23-036-00 (2.2 ml)



23-037-00 (1.8 ml)
23-038-00 (2.2 ml)

Note:- Available Both In European & American.



ARAIN

CHIP BLOWERS
LUFTBLASSER
AIRE CALIENTE

23



1/2

23-039-00



23-039-01

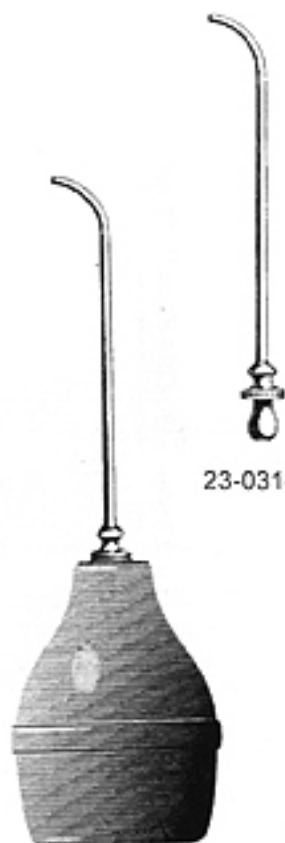

23-031-01

23-040-00



1/2

23-041-05
Without Valve

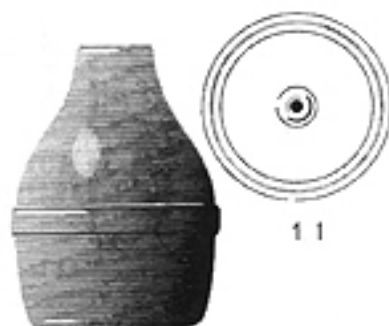

23-042-00
With Valve

1 1

CARTRIDGE SYRINGES
 INJEKTIONSKANULEN
 JERINGAS PARA CARTUCHO



23-043-00 (1.8 ml)
 23-044-01 (2.2 ml)



23-045-00 (1.8 ml)
 23-046-01 (2.2 ml)



23-049-00 (1.8 ml)
 23-048-01 (2.2 ml)



23-051-00 (1.8 ml)
 23-052-01 (2.2 ml)



23-053-00 (1.8 ml)
 23-054-01 (2.2 ml)
 Cork Screw Tip



23-055-00 (1.8 ml)
 23-056-01 (2.2 ml)



23-057-00 (1.8 ml)
 23-058-01 (2.2 ml)

Note:- Available Both In European & American.



CARTRIDGE SYRINGES
INJEKTIONSKANULEN
JERINGAS PARA CARTUCHO

23



23-059-00
INTRALIGAMENTAL SYRINGE (PISTOL Shaped)



INTRALIGAMENTAL SYRINGES



23-060-00
 Injects 0.06 ml with every click



23-061-00
 Injects 0.05 ml with every click.
 Easy attach / detach luer lock system.
 Angled tip allows easy access to inject in difficult areas.
 Special featured release button.



23-062-00
 Injects 0.05 ml with every click.
 Easy attach / detach luer lock system.
 Angled tip allows easy access to inject in difficult areas.



MATRIX RETAINERS
 MATARIZAN SPANNER
 PORAMATRICES



23-110-00



23-111-00
 Junior



23-112-00
 Senior

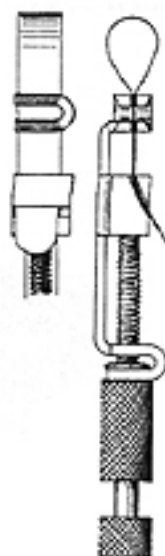

23-113-00
 Universal
 Tofflemire



23-114-00
 Ivor 1



23-115-00
 Ivor 12



1
 23-116-00



2
 23-117-00

Nystrom

Department

24

HANDLES FOR MOUTH MIRRORS
MUNDSPIEGELGRIFFE
MANGOS PARA ESPEJOS DE BOCA

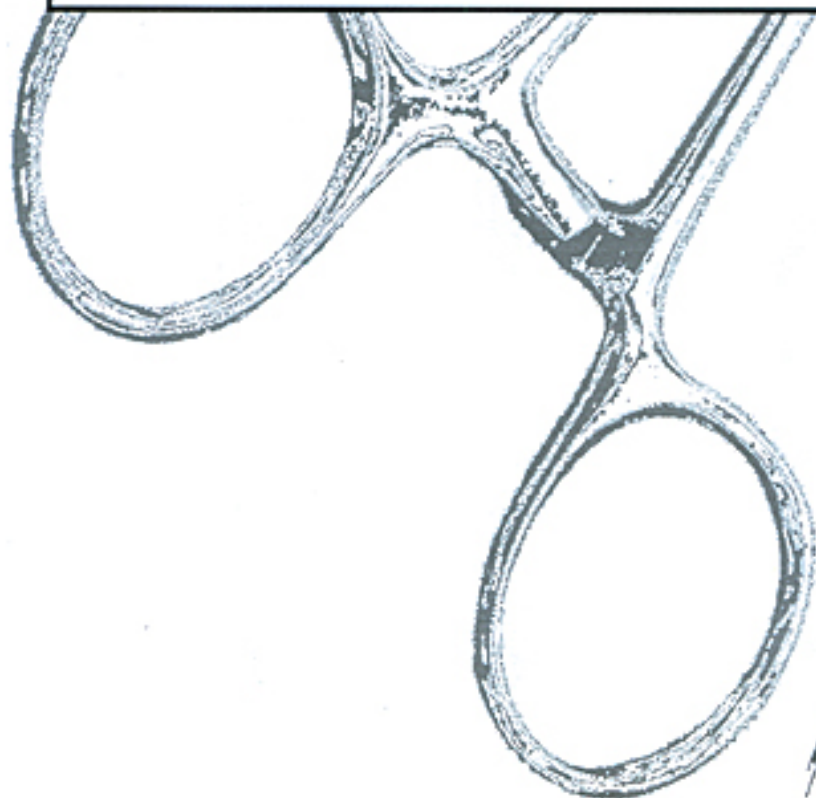
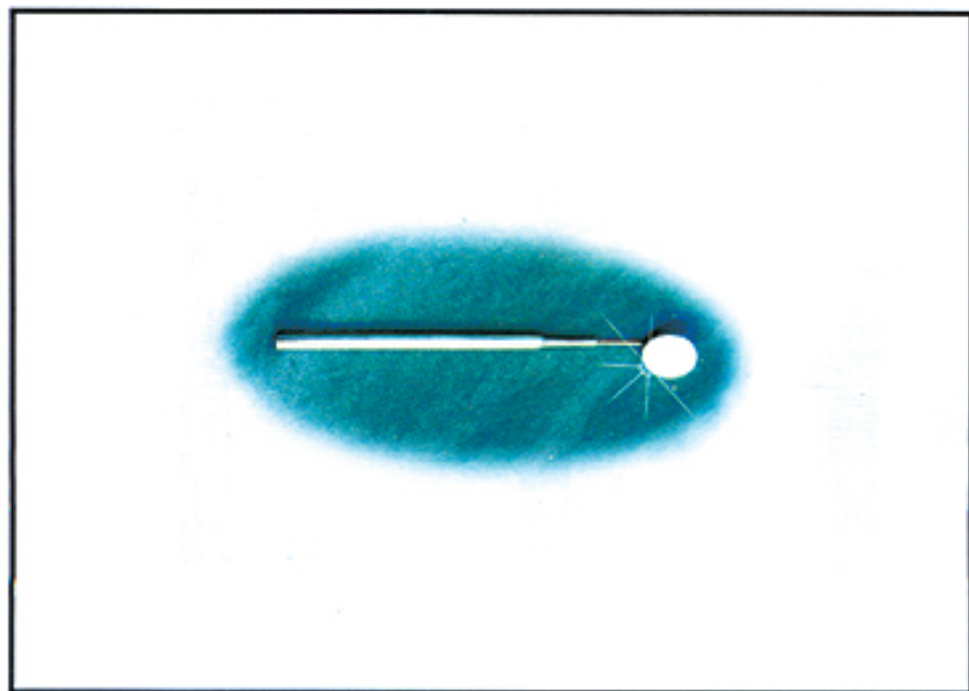

DEPARTMENT NO. 24

FROM
PAGE#

296

TO
PAGE#

300

INSTRUMENTS CATEGORY

HANDLES FOR MOUTH MIRRORS
MUNDSPIEGELGRIFFE
MANGOS PARA ESPEJOS DE BOCA

HANDLES FOR MOUTH MIRRORS
 MUNDSPIEGELGRIFFE
 MANGOS PARA ESPEJOS DE BOCA



ARAIN



24-001-00



24-002-00



24 003-00



24-004-00



24-005-00

Hollow

Solid

Note:- Available Both In European & American Thread



HANDLES FOR MOUTH MIRRORS
MUNDSPIEGELGRIFFE
MANGOS PARA ESPEJOS DE BOCA

24

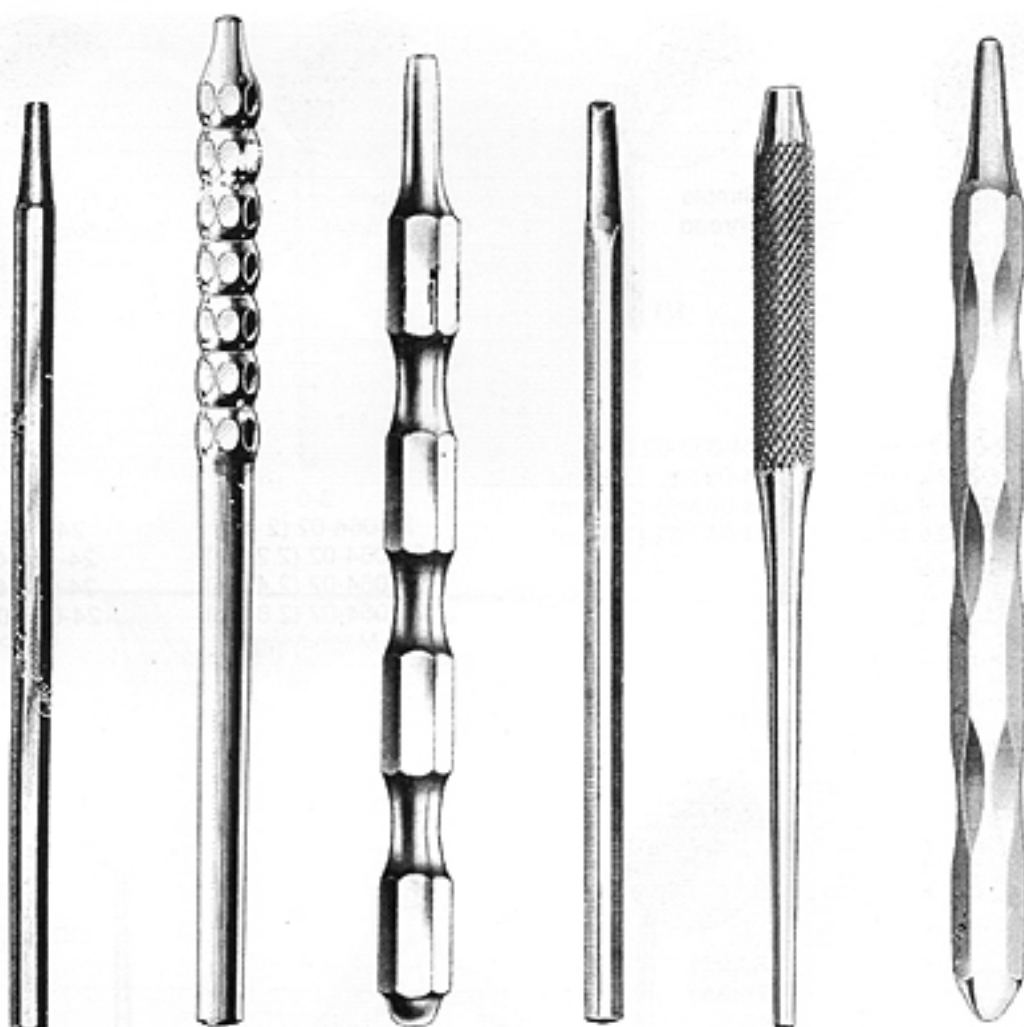

24-006-00
Solid

24-007-00
Hollow

24-008-00
Solid

483
24-009-00

487 Rs
24-010-00
Solid

489 Rs
24-011-00
Hollow

Note:- Available Both In European & American Thread

MOUTH MIRRORS
MUNDSPIEGEL
ESPEJOS DE BOCA

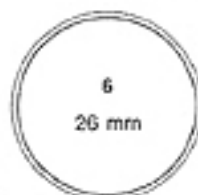
3-6

24-062-02 (2 cm)
24-062-02 (2.2 cm)
24-062-02 (2.4 cm)
24-062-02 (2.6 cm)
Magnifying



3-6

24-063-02 (2 cm)
24-063-02 (2.2 cm)
24-063-02 (2.4 cm)
24-063-02 (2.6 cm)
Plain



3-6

24-064-02 (2 cm)
24-064-02 (2.2 cm)
24-064-02 (2.4 cm)
24-064-02 (2.6 cm)
Magnifying



3-6

24-065-02 (2 cm)
24-065-02 (2.2 cm)
24-065-02 (2.4 cm)
24-065-02 (2.6 cm)
Plain



3-6

24-066-02 (2 cm)
24-066-02 (2.2 cm)
24-066-02 (2.4 cm)
24-066-02 (2.6 cm)
Plain (Front Surface)
Rhodium Plated



24-070-00

Note:- Available both in European & American Thread.
All Mouth Mirrors are also Available Twelve Pieces in one Packing.

Department

25

SCALPLE HANDLES
SKALPELL-GRIFFE
MANGOS DE BISTURIAS

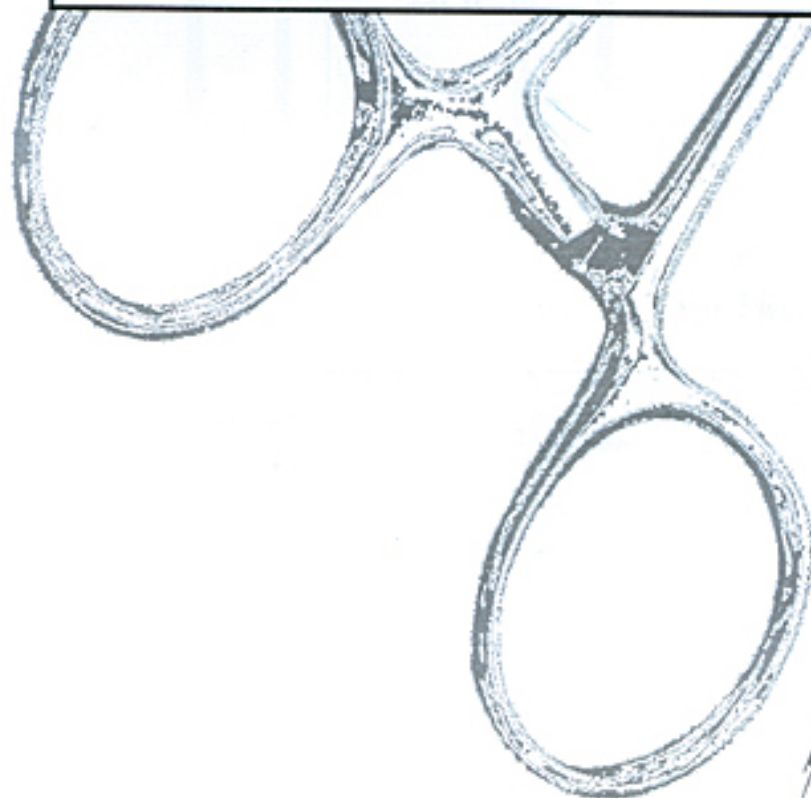

DEPARTMENT NO. 25

FROM
PAGE#

301

TO
PAGE#

304

INSTRUMENTS CATEGORY

SCALPLE HANDLES
SKALPELL-GRIFFE
MANGOS DE BISTURIES



FRET SAWS
LAUBSAGEBOGAN
PORTA-SIERRAS

25



25-001-20
20 cm
Model Saw

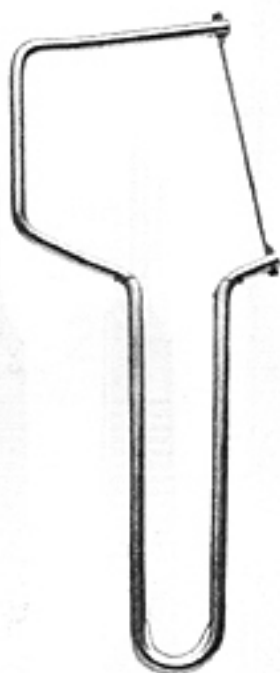

25-002-18
18 cm
Bowed
Model Saw

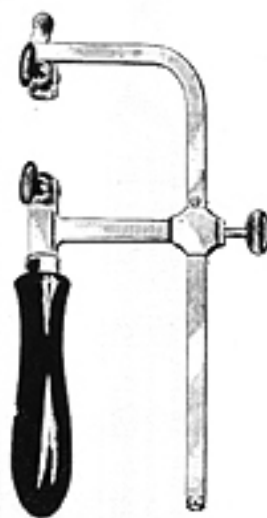

25-003-00
Fret Saw Frames,
Adjustable

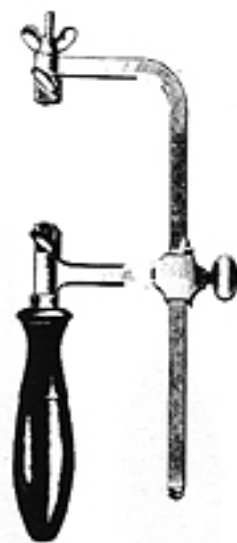

25-004-00
Fret Saw Frames,
Adjustable

SCALPLE HANDLES
SKALPELL-GRIFFE
MANGOS DE BISTURIAS



3
25-055-00



4
25-056-00

┌ BakeLite ─┐



4
25-057-00
Solid



3 L
25-058-00



3
25-059-00



3 G
25-060-00



8
25-061-00



7
25-062-00

Department

26

HAMMER
MALLET
MARTILLOS Y MAZOS

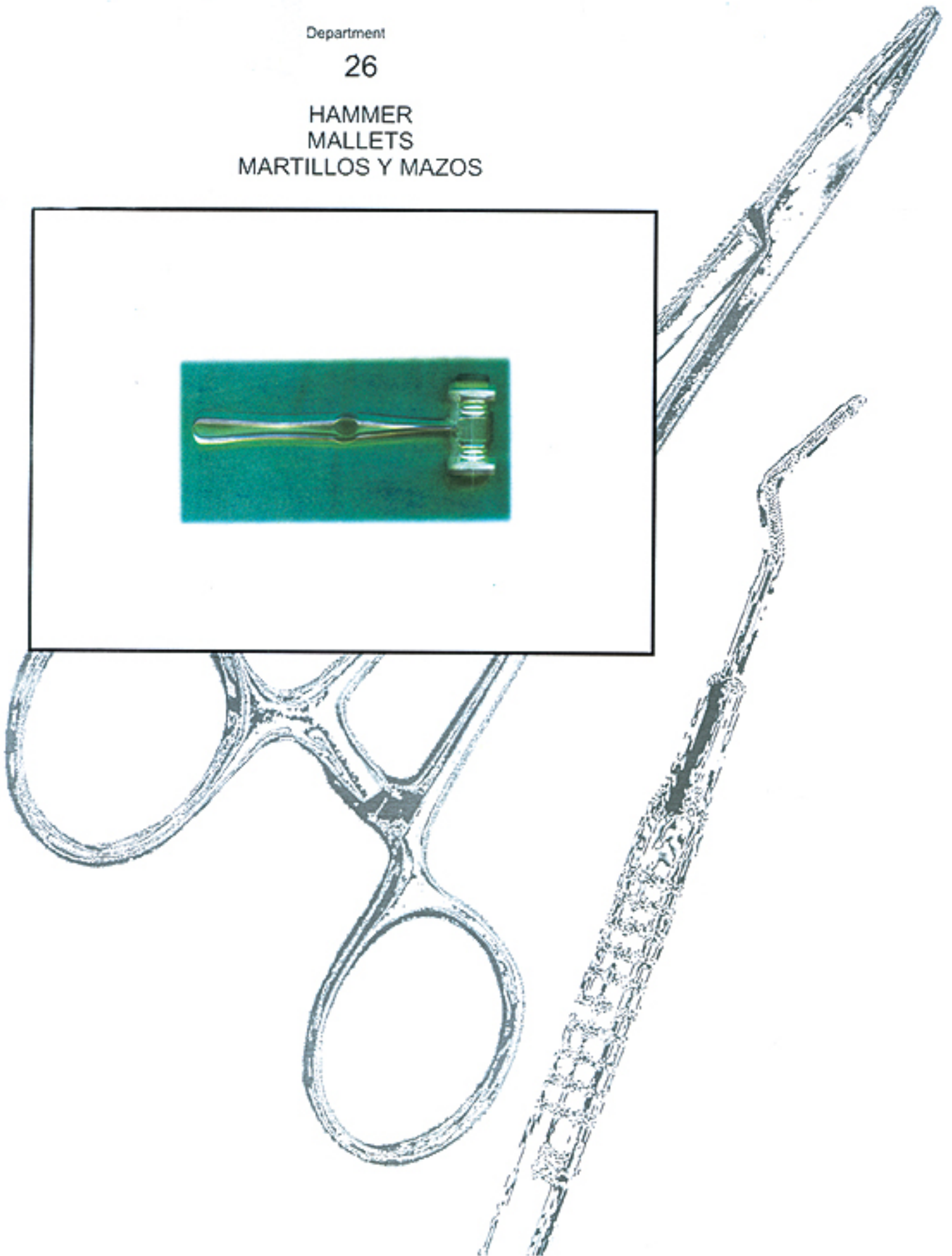
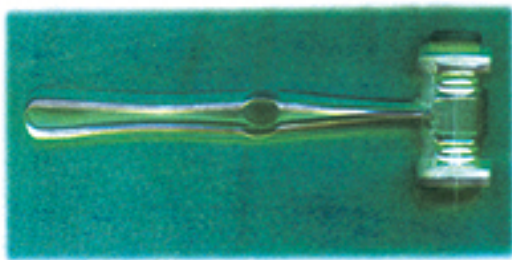

DEPARTMENT NO. 26

FROM
PAGE#

305

TO
PAGE#

308

INSTRUMENTS CATEGORY

HAMMER
MALLET
MARTILLOS Y MAZOS



HAMMERS
MALLETS
MARTILLOS Y MAZOS

26



26-001-22
22 cm
Riveting Mallets



26-002-22
22 cm



26-003-20
20 cm
Horn Mallet

HAMMER
MALLETS
MARTILLOS Y MAZOS



ARAIN

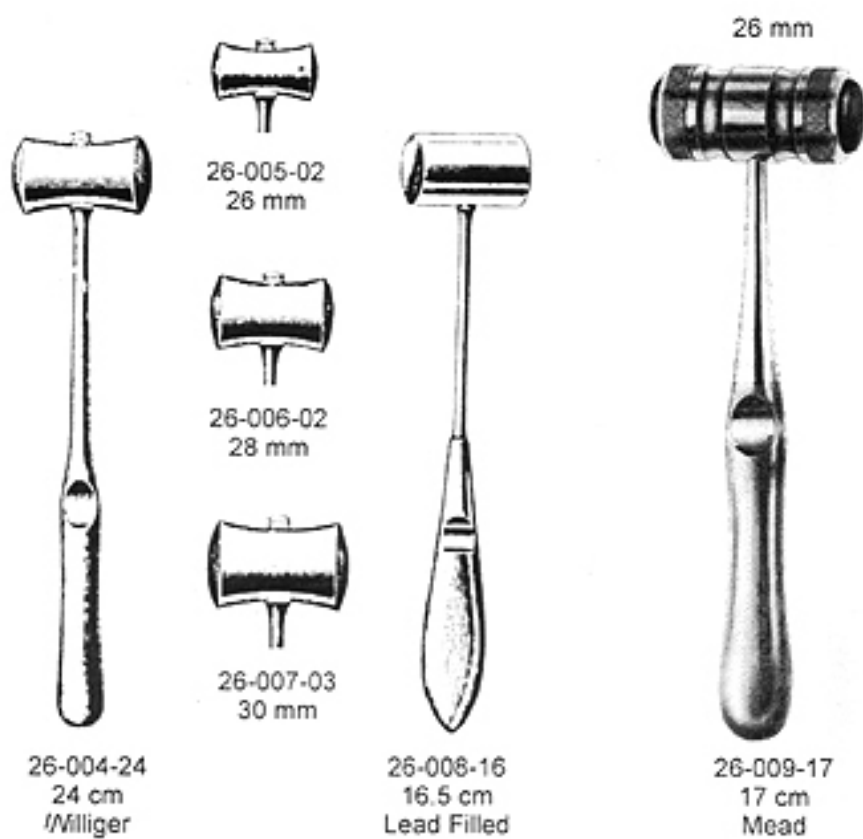

Department

27

CARVING INSTRUMENTS
MODELLIER INSTRUMENTE
INSTRUMENTOS PARA MODELAR

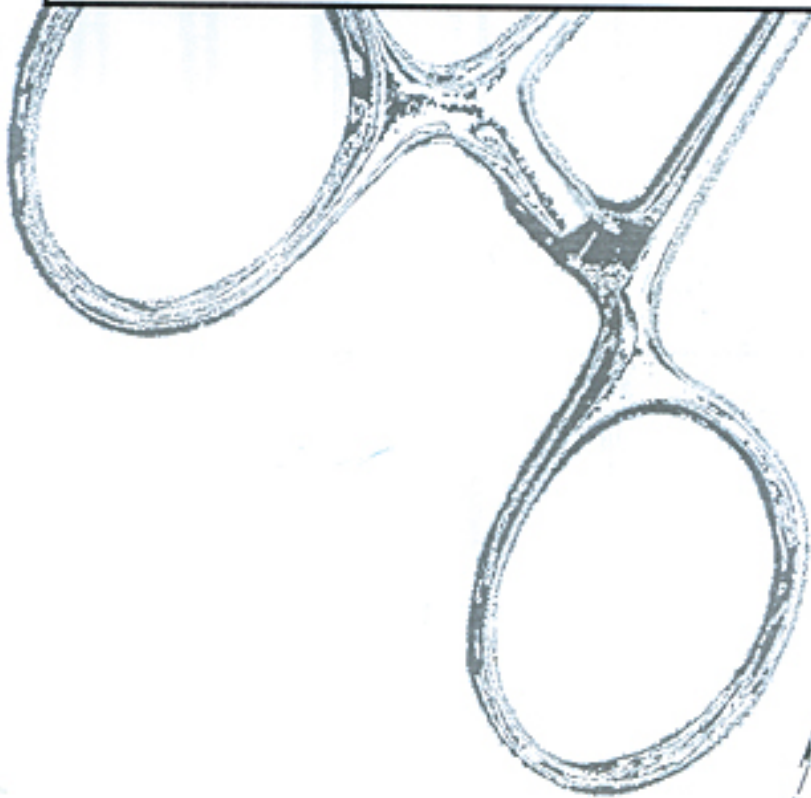

012

DEPARTMENT NO. 27

FROM
PAGE#

309

TO
PAGE#

318

INSTRUMENTS CATEGORY

CARVING INSTRUMENTS
MODELLIER INSTRUMENTE
INSTRUMENTOS PARA MODELAR



1 2 3
1-3
27-001-00
Nystrom

1 1S 2
1-2
27-002-00
Ward

27-003-00
Ward

27-004- 0
Baltimore

27-004-10
Gritman

27-005-00
Vehe

27-001-01 27-001-02 27-001-3 27-002-01 27-002-1S 27-002-02

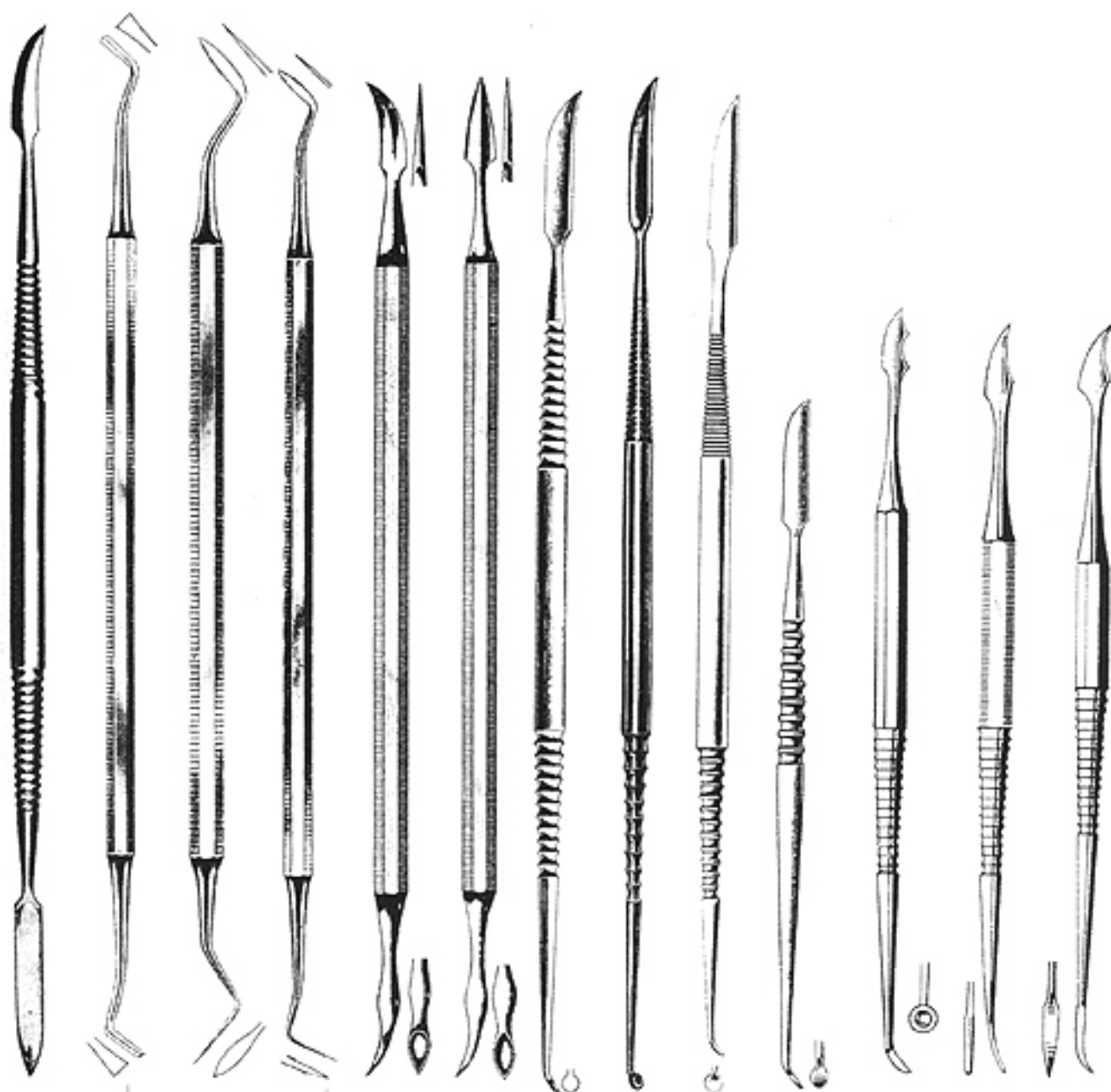

27-006-00
Reeve
27-007-00
Hollenback

27-008-00
Hollenback
27-009-00
Hollenback

27-010-00
Roach
27-011-00
Roach

27-012-00
Le Cron
27-013-00
Le Cron

27-014-00
Le Cron
27-015-00
Le Cron

27-016-00
Zahle
27-017-00
Zahle

27-018-00
Zahle



ARAIN

WAX AND MODELLING CARVERS
WACHS-UND MODELLIER INSTRUMENTE
TALLADORES PARA CERA Y PARA MODELAR

27



27-019-00
Hyllin



27-020-00
Hyllin-Le Cron



27-021-00
Hyllin-Ceramica



27-022-00
Hyllin



27-023-00



27-024-00
Le Cron



27-025-00
Le Cron

M. A. ARAIN & BROTHERS (PVT.) LTD.

313



WAX AND MODELLING CARVERS
WACHS-UND MODELLIER INSTRUMENTE
TALLADORES PARA CERA Y PARA MODELAR

27



27-019-00
Hyllin



27-020-00
Hyllin-Le Cron



27-021-00
Hyllin-Ceramica



27-022-00
Hyllin



27-023-00



27-024-00
Le Cron



27-025-00
Le Cron



27-026-00

7
27-027-007A
27-028-00

27-029-00

45
27-030-00

Beale



MODELLING CARVERS
MODELLIER INSTRUMENTE
TALLADORES PARA MODELAR

27



27-031-00
Taylor

27-032-00
Falck

27-033-00
Beale

27-034-00
Acker

27-035-00
Handle, Only

27-036-00
Attachment Only

27-037-00
Attachment Only

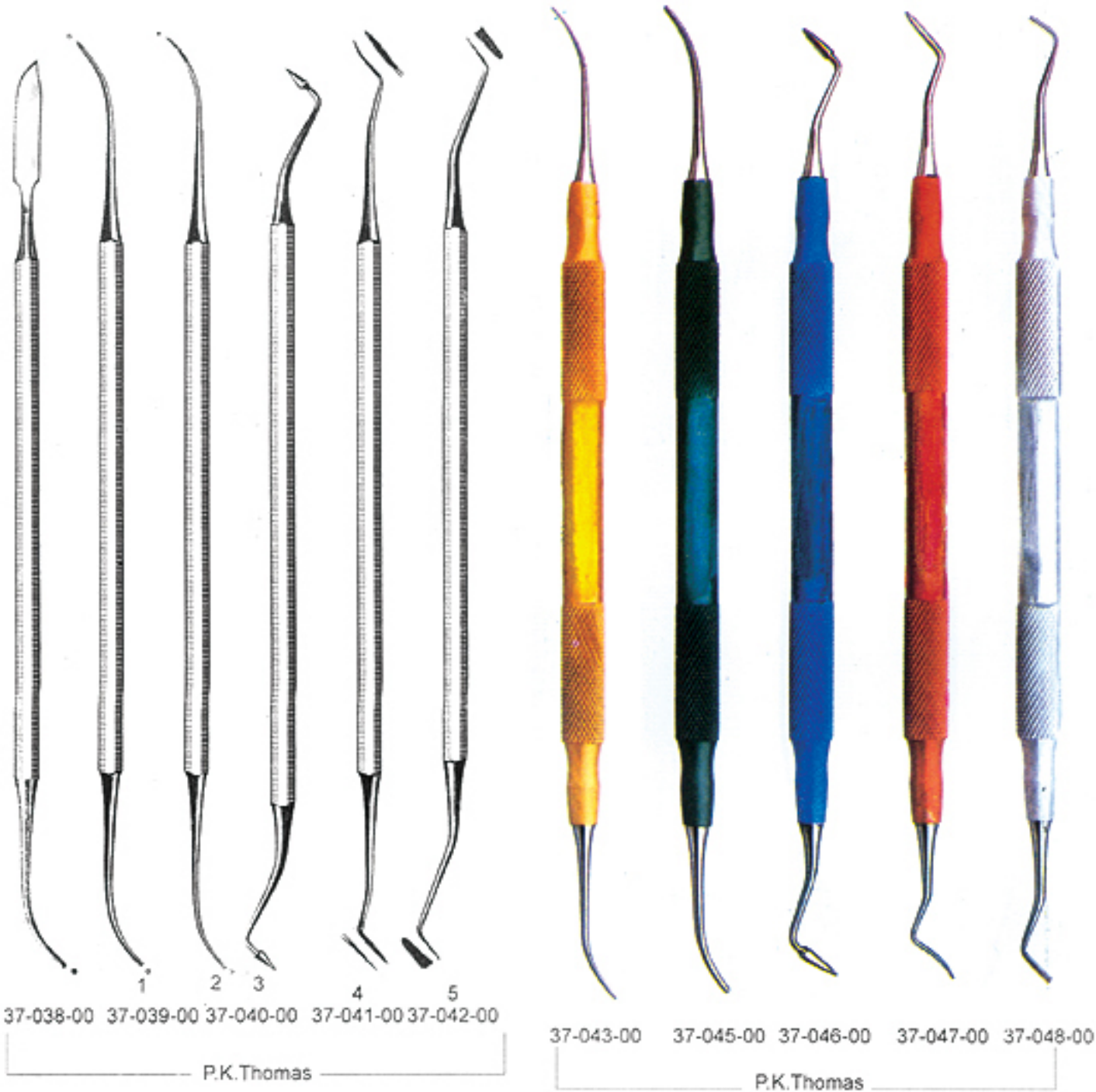



CARVING INSTRUMENTS
MODELLIER INSTRUMENTE
INSTRUMENTOS PARA MODELAR

27

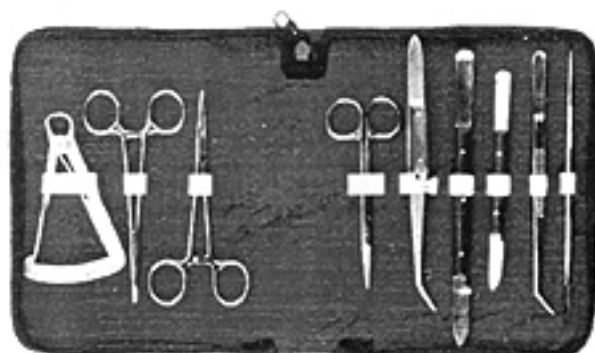

27-049-00
Modeling Instrument
Set in Pouch.

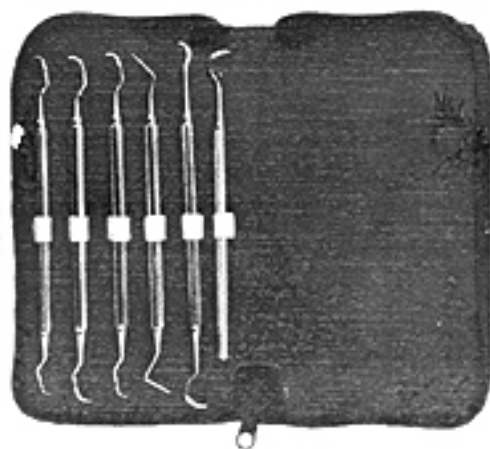

37-050-00
Modeling Instrument
Set in Pouch.

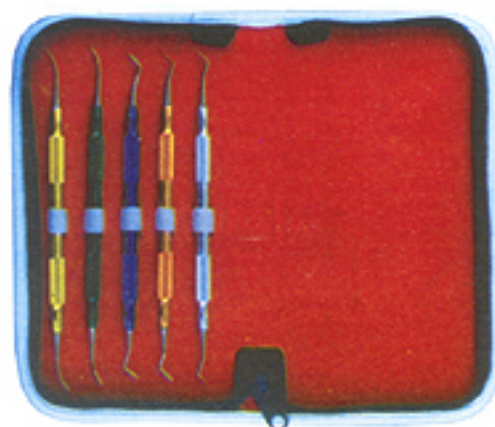

37-051-00
Modeling Instrument
Set in Pouch.

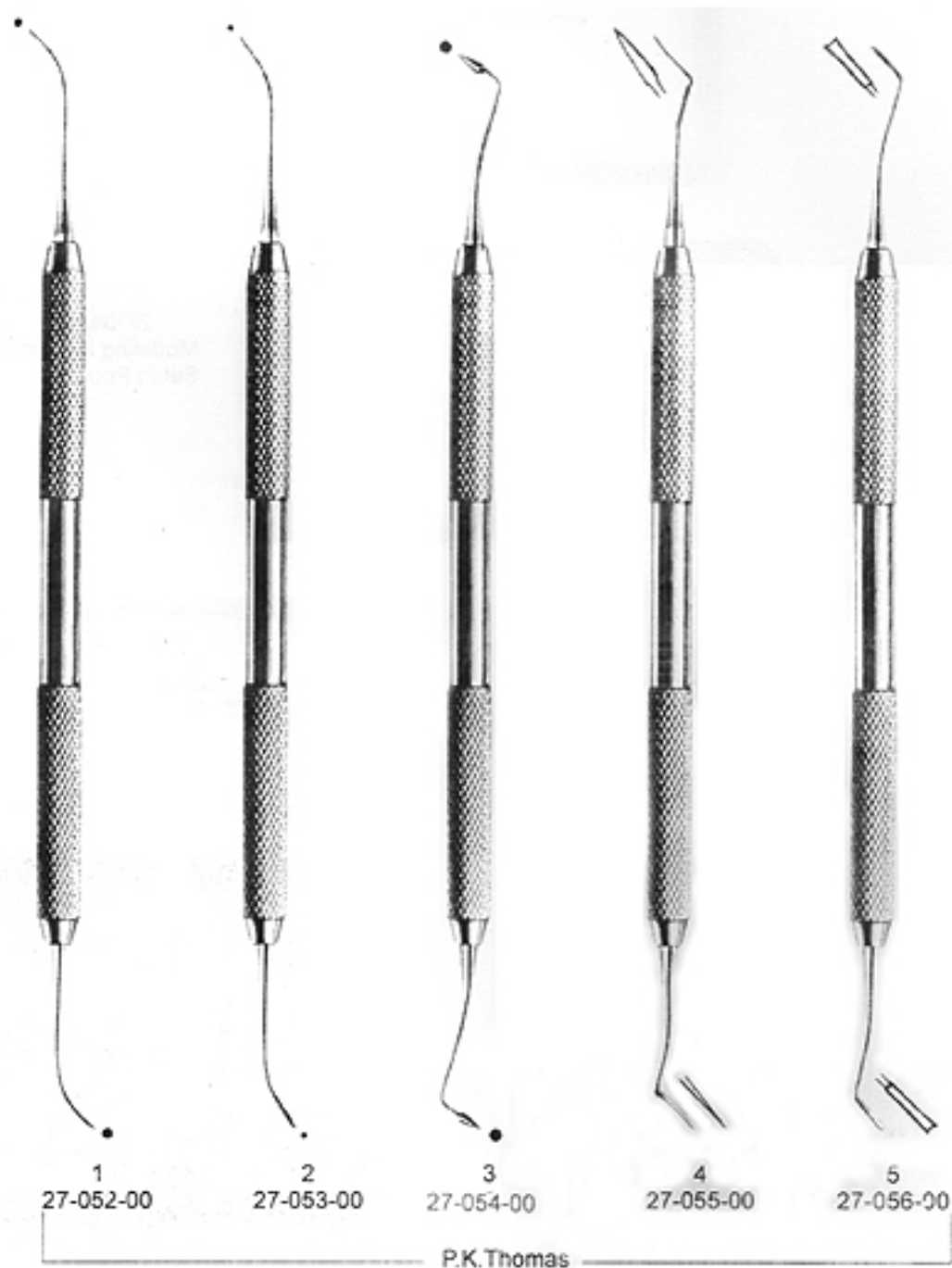



27-058-01



27-059-02

27-057-00



27-061-01



27-062-02

27-060-00



27-064-01



27-065-02

27-063-00

INSTRUMENTOS PARA MOLDEAR LA CERAMICA
MODELIERUNGSTRUMENTE FÜR KERAMIK
CERAMIC SHAPING INSTRUMENTS



ARAIN



M. A. ARAIN & BROTHERS (PVT.) LTD.

Department

28

WAX KNIVES
WACHSMESSER
CUCHILLOS PARA CERA

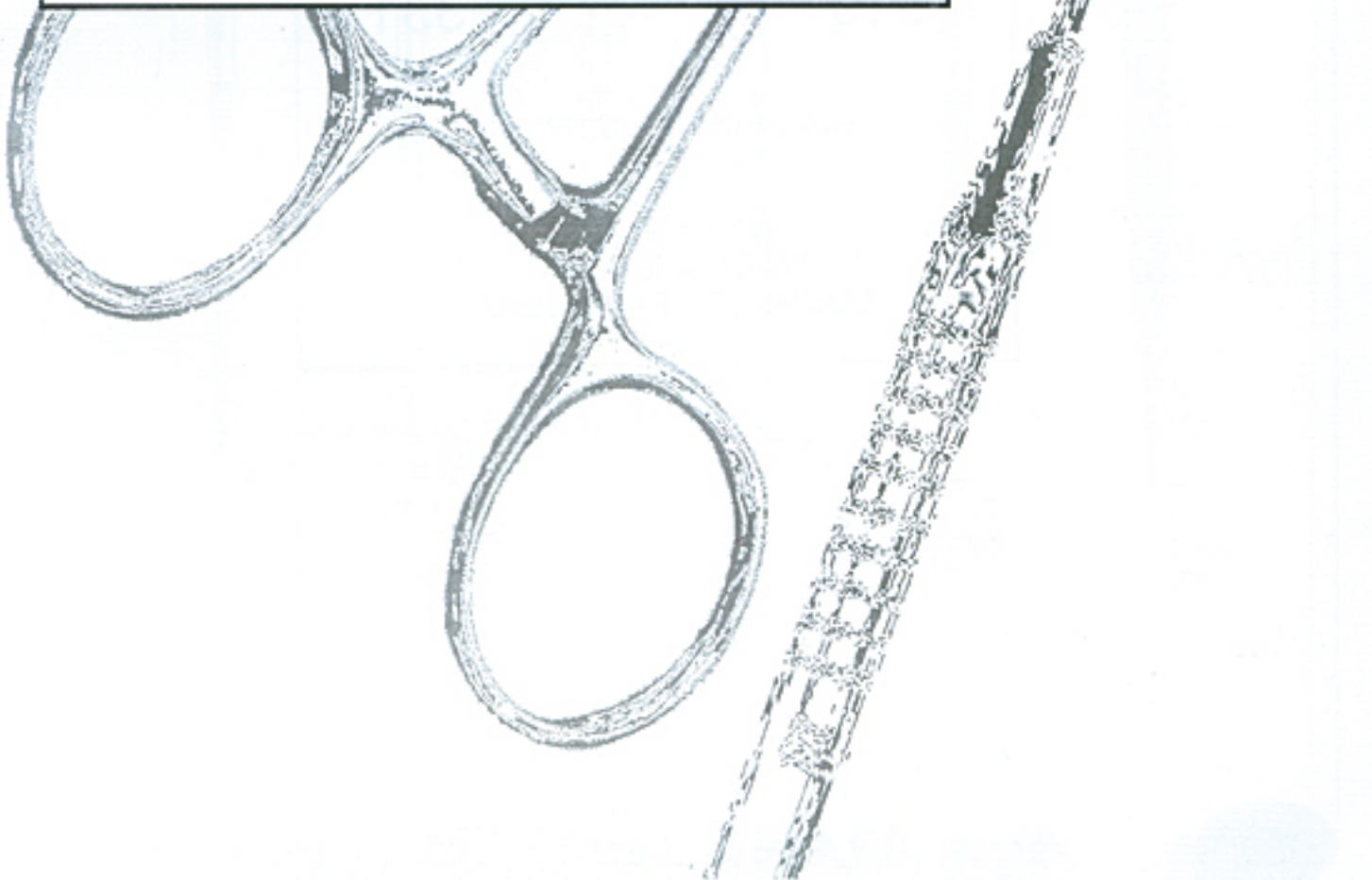

DEPARTMENT NO. 28

FROM
PAGE#

319

TO
PAGE#

331

INSTRUMENTS CATEGORY

WAX KNIVES
WACHSMESSER
CUCHILLOS PARA CERA



ARAIN

WAX KNIVES
WACHSMESSER
CUCHILLOS PARA CERA

28

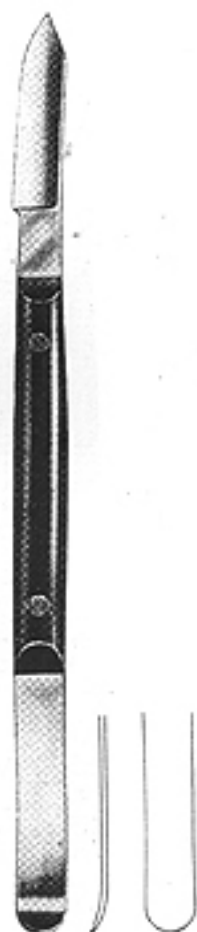

28-001-13
13 cm

Fahnenstock



28-002-17
17.5 cm

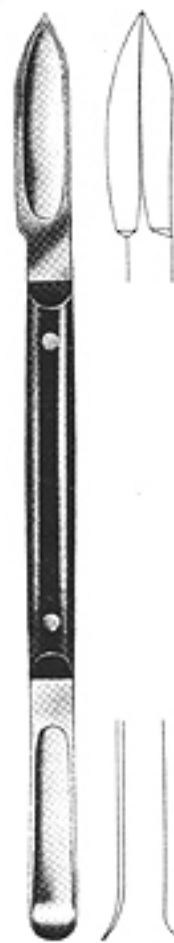

28-003-13
13 cm

Lessmann



28-004-17
17.5 cm

M. A. ARAIN & BROTHERS (PVT.) LTD.

321

WAX KNIVES
WACHSMESSER
CUCHILLOS PARA CERA



ARAIN



28-005-13
13 cm

28-006-13
13 cm

28-007-13
13 cm

28-008-17
17 cm

28-009-00

28-010-00

Emert



ARAIN

WAX KNIVES
WACHSMESSER
CUCHILLOS PARA CERA

28



28-012-00



28-013-00
Sach

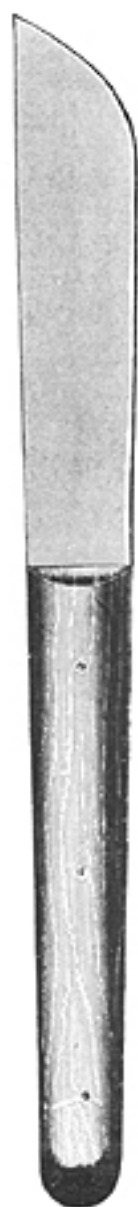

28-014-00



28-015-00
Gritman

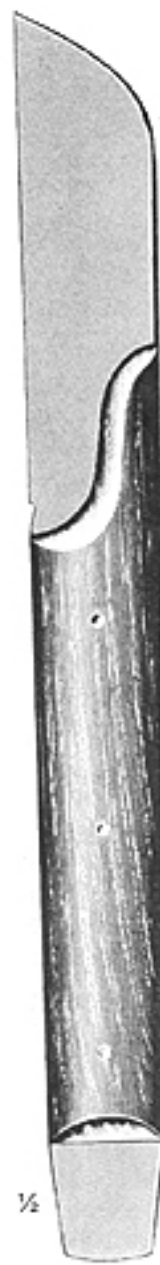

1/2

28-016-00

M. A. ARAIN & BROTHERS (PVT.) LTD.

323

ALGinate AND PLASTER SPATULAS
 ALGinate UND GIPSPATEL
 ESPATULAS PARA ALGinate Y PARA YESO



ARAIN

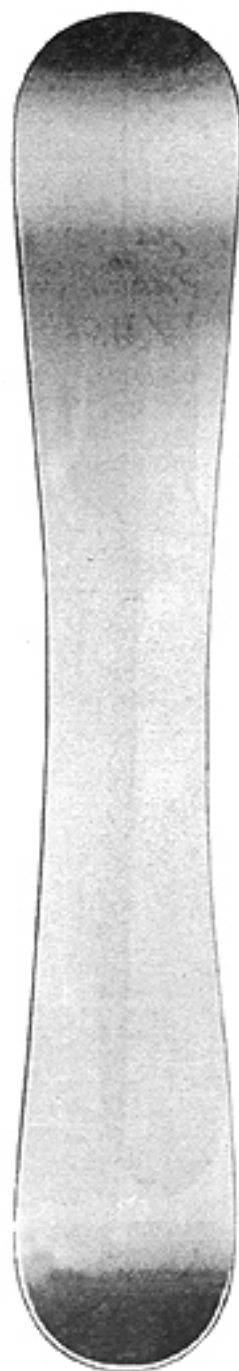

28-063-00

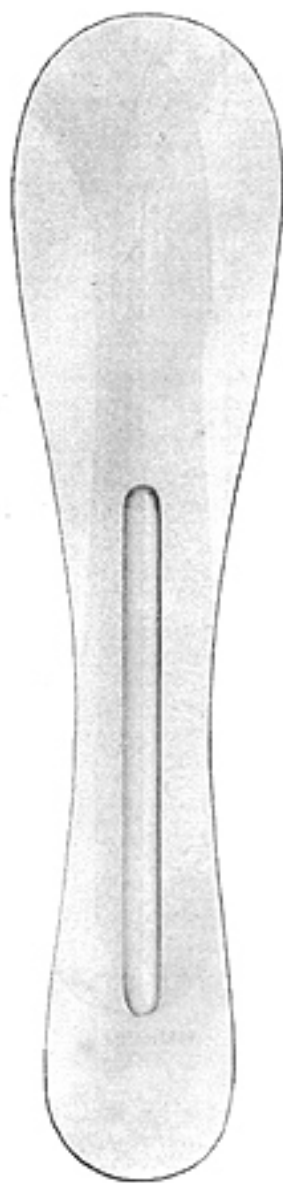
28-064-00
Lichtenstein28-065-00
Flexibel

28-066-00

28-067-00
Flexibel



ALGINATE AND PLASTER SPATULAS
ALGINATE UND GIPSPATEL
ESPATULAS PARA ALGINATO Y PARA YESO

28



28-068-18
18.5 cm



28-069-19
19.5 cm



28-070-21
21.5 cm



28-071-20
20.5 cm

PLASTER CUTTING FORCEPS
GIPSSCHNEIDE UND GIPSBRUCHZANGE
ALICATE PARA YESO

ARAIN



28-122-00

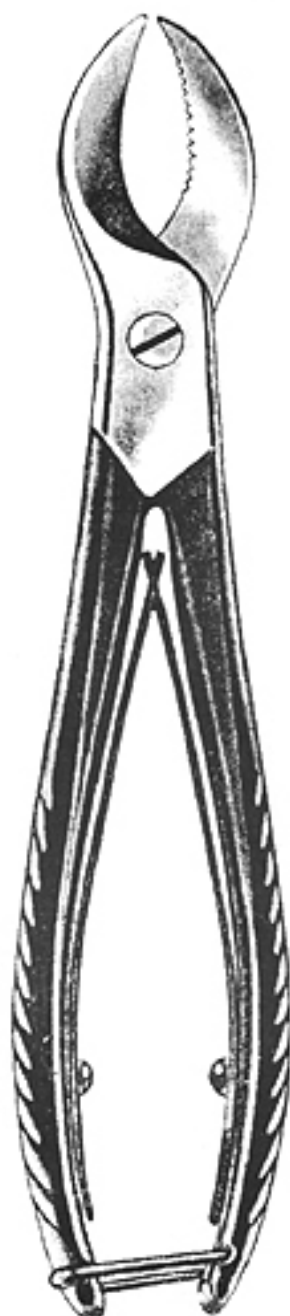

28-123-00



28-124-00



INSTRUMENTS FOR CROWN WORK
KRONEN WERK INSTRUMENTE
INSTRUMENTOS PARA CORONAS

28



28-165-15
15 cm



28-166-15
15 cm
Miller

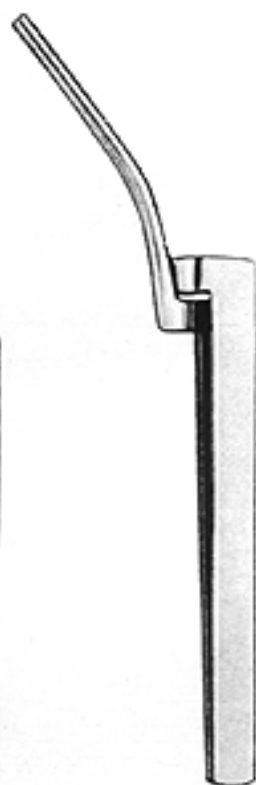

28-167-15
15 cm

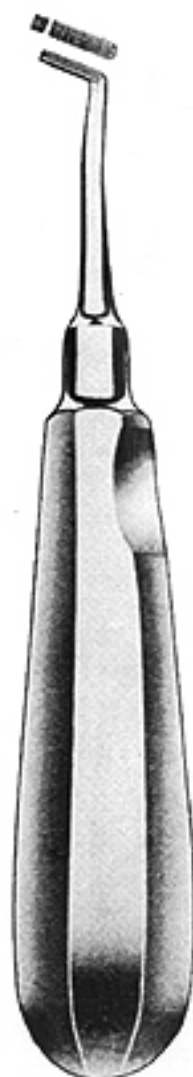

28-168-00
Mershon



1/1

28-169-00



1/1

28-170-00
Steiner

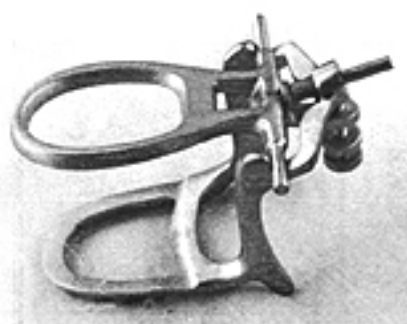

28-220-00
Full Arch
Chrome Plated

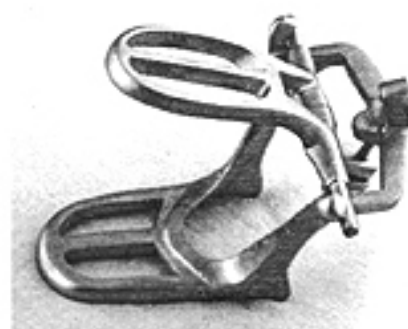

28-221-00
Denture
Chrome Plated



28-222-00

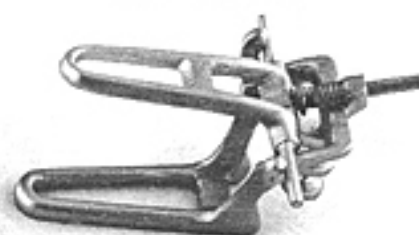

28-223-00
Crowned Bridge
Chrome Plated

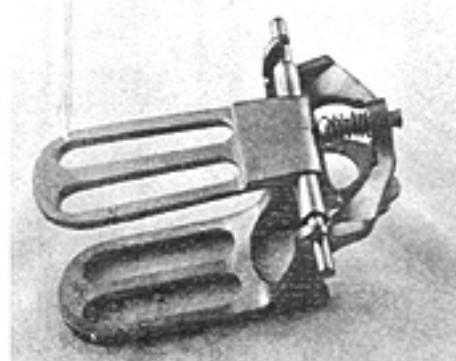

28-224-00
Full Denture
Chrome Plated



28-225-00



ARAIN

**SOLDERING TWEEZERS
LOTPINZETTEN
PINZAS PARA SOLDAR**

28

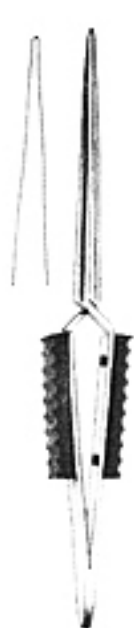

28-275-16
16 cm



28-276-16
16 cm



28-277-12
28-278-16
12 cm
16 cm



28-279-12
28-280-16
12 cm
16 cm



28-285-16
16 cm



28-286-16
16 cm



28-281-10
10.5 cm



28-282-10
10.5 cm



28-283-16
16 cm



28-284-16
16 cm

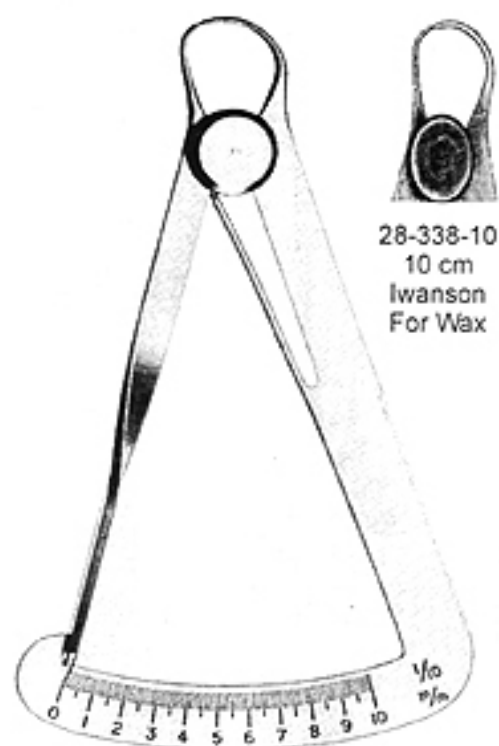

28-337-10
 10 cm
 Iwanson
 For Metal



28-338-10
 10 cm
 Iwanson
 For Wax



28-339-00



28-340-00
 Boley



ARAIN

MEASURING INSTRUMENTS
MANIKURE INSTRUMENTE
INSTRUMENTOS PARA MEDIR

28



28 341-00



28-342-00
Beerendonk



28-343-00

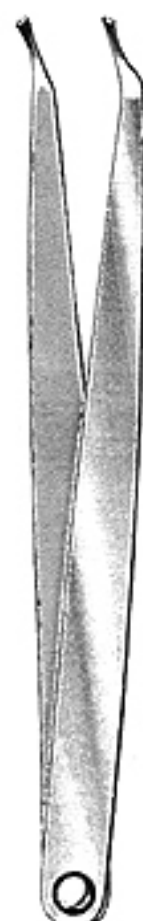

28-344-00
Korbit

Department

29

STAINLESS STEEL IMPRESSION TRAYS
ABDRUCKLOFFEL AUS EDELSTAHL
CUBETAS PARA DE ACERO INOXIDABLE

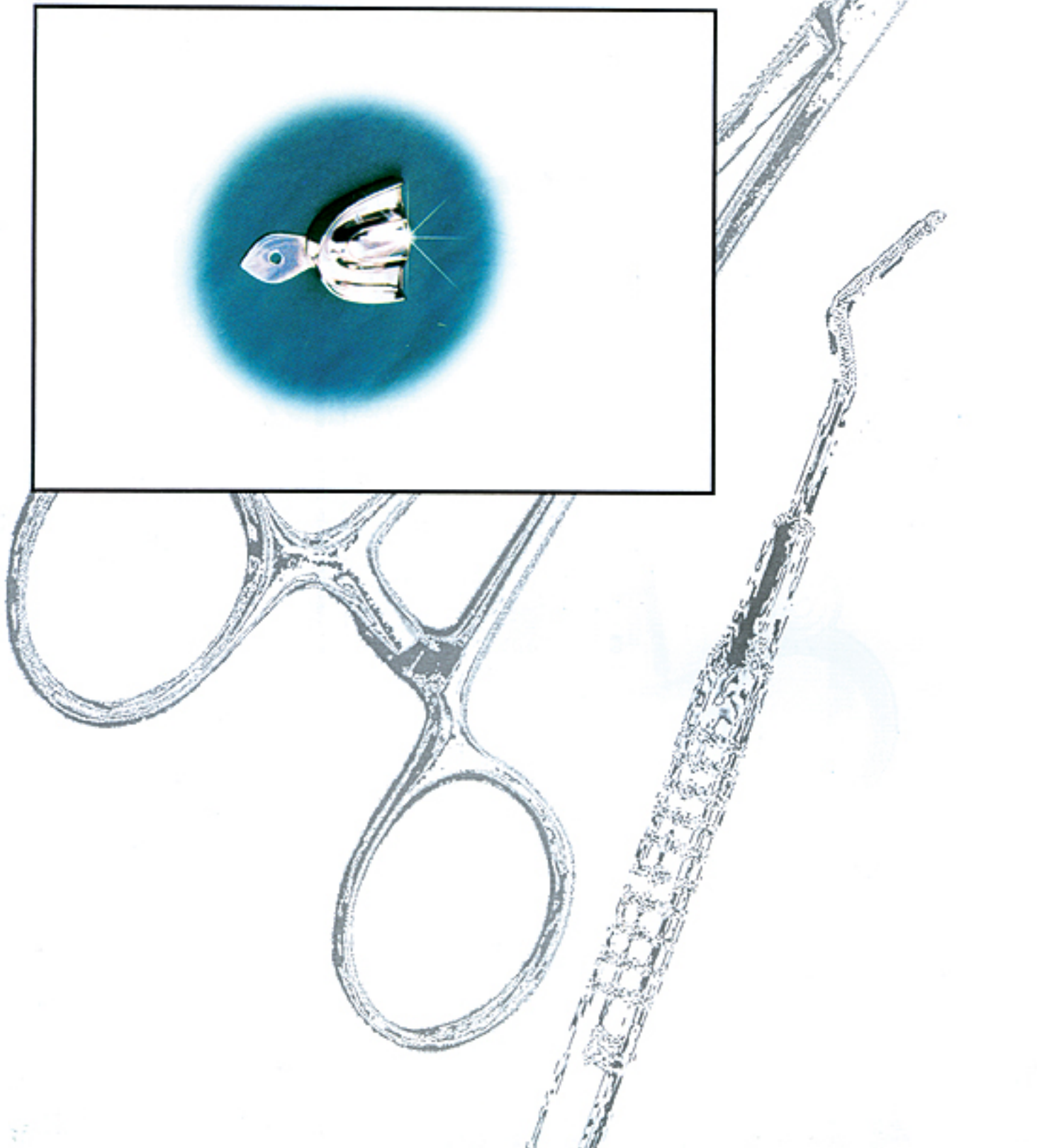

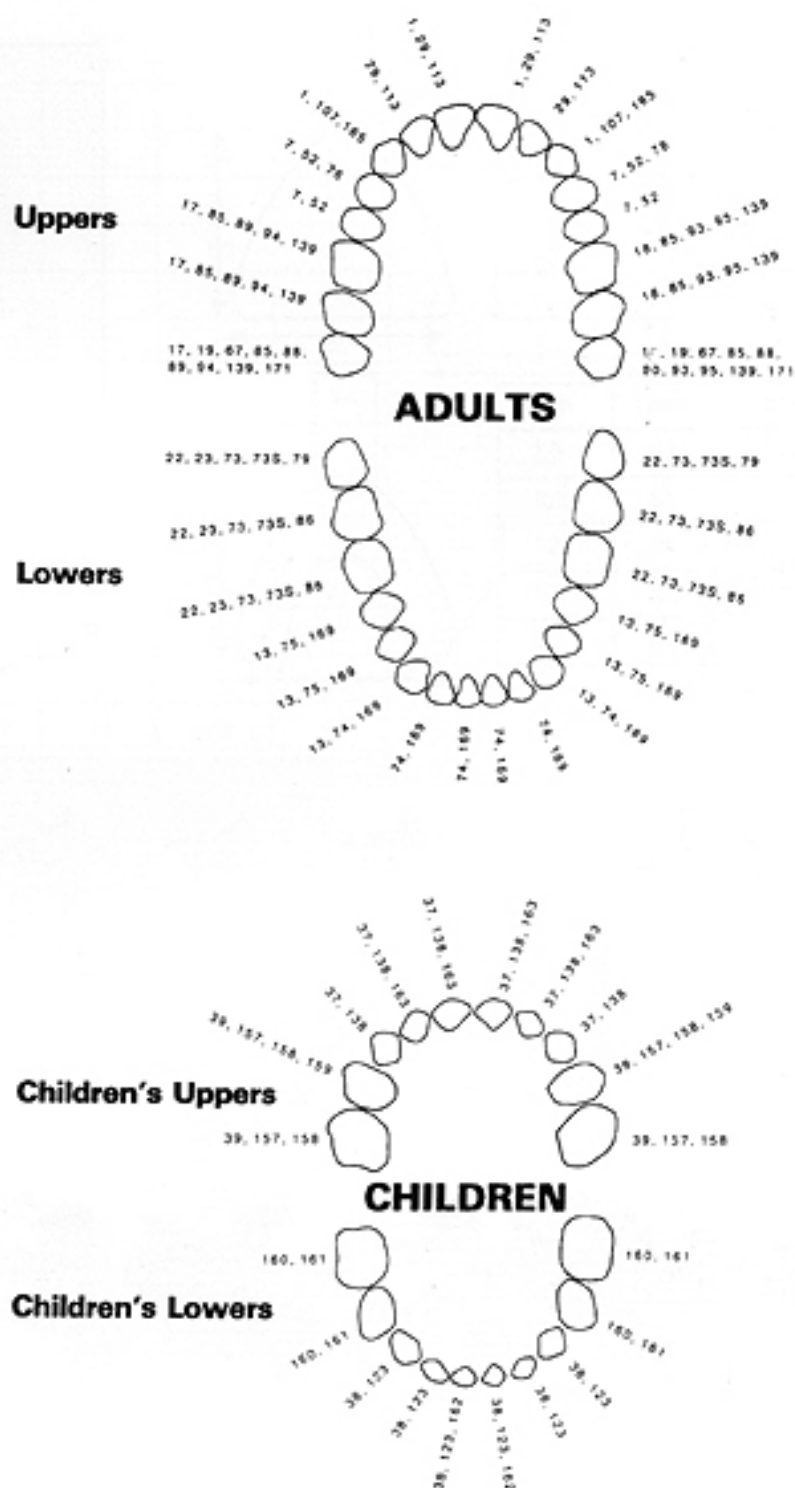

STAINLESS STEEL IMPRESSION TRAYS
 ABDRUCKLOFFEL AUS EDEL STAHL
 CUBETAS PARA DE ACERO INOXIDABLE





SUPER (Rim Lock)

29-001-00

► Set of 10 pieces

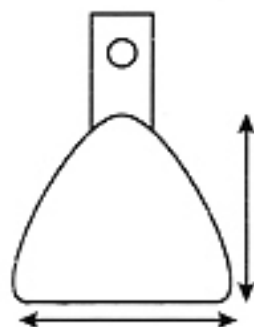
Numbers	Size	mm.	mm.
29-001-U1	XL	81	63
29-002-U2	L	74	60
29-003-U3	M	71	55
29-004-U4	NM	67	53
29-005-U4	S	65	51



Numbers	Size	mm.	mm.
29-006-L1	XL	80	63
29-007-L2	L	78	59
29-008-L3	M	76	57
29-009-L4	NM	72	57
29-010-L5	S	69	50

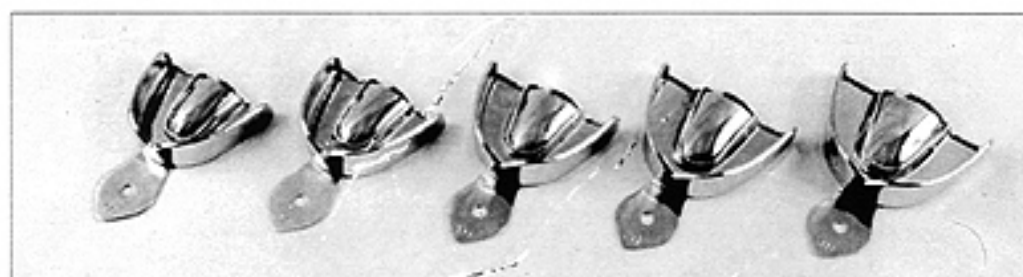
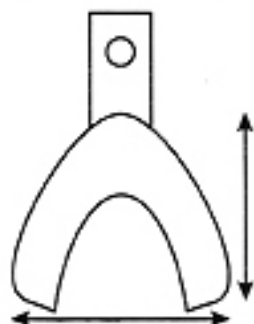

29-005-U5

29-004-U4

29-003-U3

29-002-U2

29-001-U1

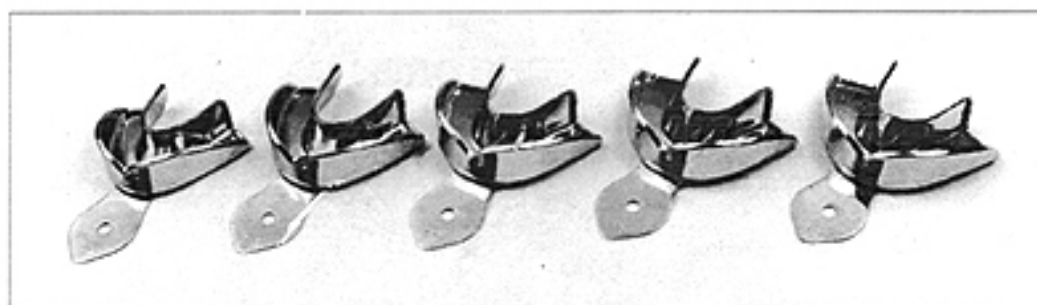

29-010-L5

29-009-L4

29-008-L3

29-007-L2

29-006-L1



STAINLESS STEEL IMPRESSION TRAYS
ABDRUCKLOFFEL AUS EDELSTAHL
CUBETAS PARA DE ACERO INOXIDABLE

29

29-002-00

→ Set of 10 pieces

REGULAR (Rim Lock)

Numbers	Size	mm.	mm.
29-011-U1	XXS	61	47
29-012-U2	XS	64	51
29-013-U3	S	66	53
29-014-U4	M	69	57
29-015-U5	L	71	60
29-015-U6	XL	73	62

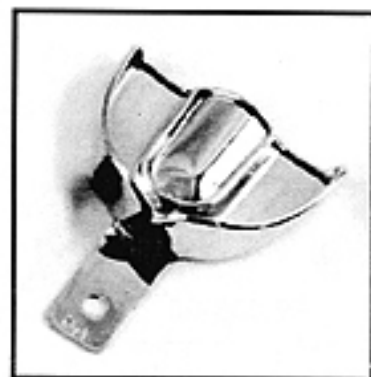
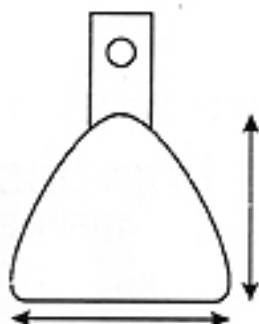

Numbers	Size	mm.	mm.
29-017-L1	XXS	55	47
29-018-L2	XS	60	49
29-019-L3	S	72	54
29-020-L4	M	75	57
29-021-L5	L	76	59
29-022-L6	XL	78	61

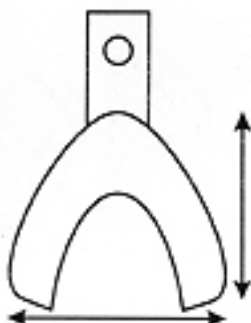

29-011-U1 29-012-U2 29-013-U3 29-014-U4 29-015-U5 29-016-U6



29-017-L1 29-018-L2 29-019-L3 29-020-L4 29-021-L5 29-022-L6

STAINLESS STEEL IMPRESSION TRAYS
 ABDRUCKLOFFEL AUS EDELSTAHL
 CUBETAS PARA DE ACERO INOXIDABLE





Crown and bridge work Impression trays

STAINLESS STEEL

29-003-00

Set of 6 pieces

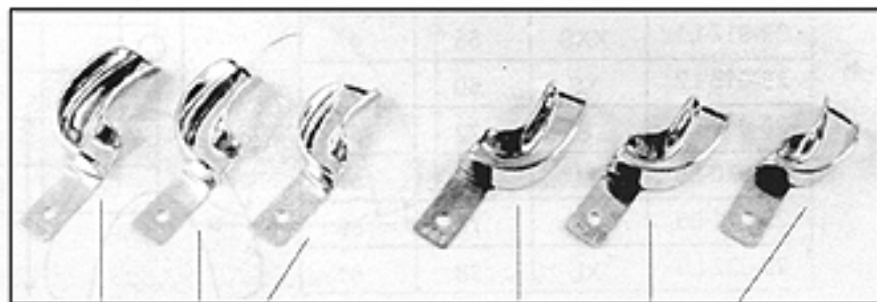
Number	Size
29-023-L6D	S
29-024-L4D	M
29-025-L2D	L
29-026-L6S	S
29-027-L4S	M
29-028-L2S	L



29-025-L2D
 29-024-L4D
 29-023-L6D

29-028-L2S
 29-027-L4S
 29-026-L6S

Number	Size
29-029-L1P	S
29-30-U1P	S

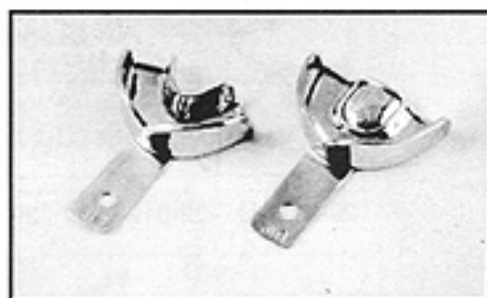

29-029-L1P 29- 30-U1P



STAINLESS STEEL IMPRESSION TRAYS
 ABDRUCKLOFFEL AUS EDELSTAHL
 CUBETAS PARA DE ACERO INOXIDABLE

29

29-004-44

Set of 12 Pieces (Without Rim Lock)

Numbers	Size	mm.	mm.
29-031-U1	XXS	61	47
29-032-U2	XS	64	51
29-033-U3	S	66	53
29-034-U4	M	69	57
29-035-U5	L	71	60
29-035-U6	XL	73	62

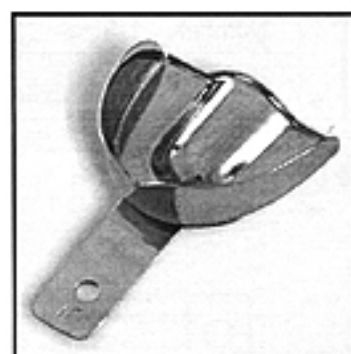
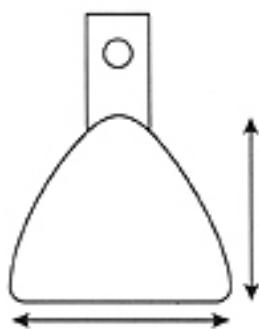

Numbers	Size	mm.	mm.
29-037-L1	XXS	65	47
29-038-L2	XS	60	49
29-039-L3	S	72	54
29-040-L4	M	74	57
29-041-L5	L	76	59
29-042-L6	XL	78	61

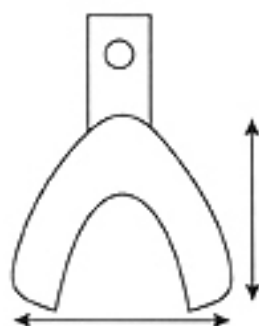

29-031-U1 29-032-U2 29-033-U3 29-034-U4 29-035-U5 29-035-U6

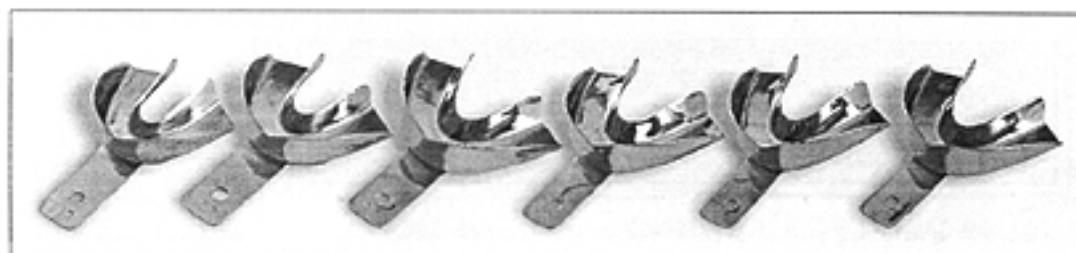

29-037-L1 29-038-L2 29-039-L3 29-040-L4 29-041-L5 29-042-L6

STAINLESS STEEL IMPRESSION TRAYS
 ABDRUCKKLOFFEL AUS EDELSTAHL
 CUBETAS PARA DE ACERO INOXIDABLE

ARAIN



DEPRESSED ANTERIOR (Rim Lock)

29-005-00

Set of 6 pieces

Number	Size	mm.	mm.
29-043-U1	L	81	67
29-044-U4	M	71	64
29-045-U7	S	70	57

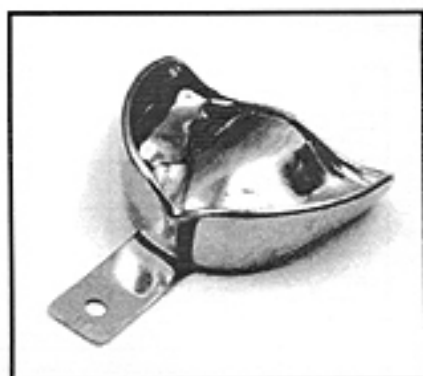
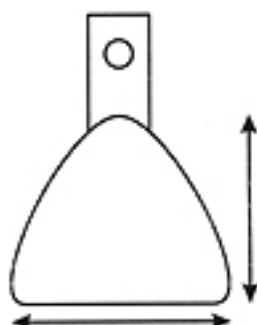

Number	Size	mm.	mm.
29-046-L20	L	81	60
29-047-L21	M	79	57
29-048-L22	S	76	54

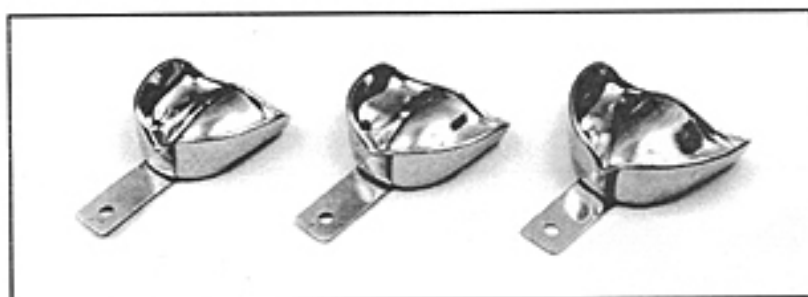
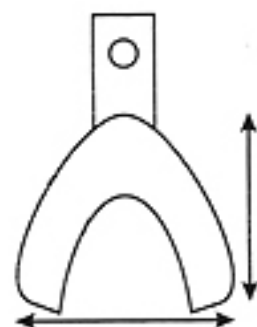

29-045-U7

29-044-U4

29-043-U1

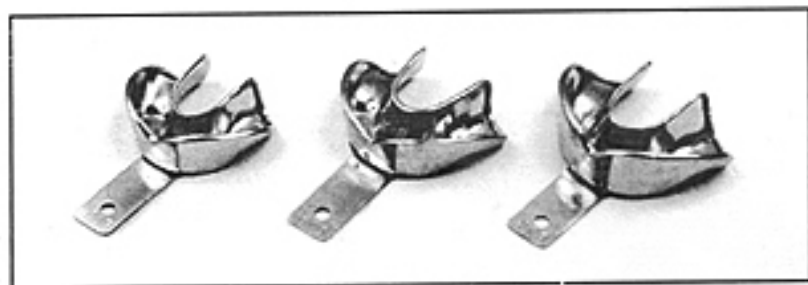

29-048-L22

29-047-L21

29-046-L20



STAINLESS STEEL IMPRESSION TRAYS
 ABDRUCKLOFFEL AUS EDELSTAHL
 CUBETAS PARA DE ACERO INOXIDABLE

29

DENTURE / EDENTOLOUS

29-006-00

Set of 8 pieces



Number	Size	mm.	mm.
29-049-U61	L	79	70
29-050-U62	M	76	67
29-051-U63	NM	70	64
29-052-U64	S	73	60

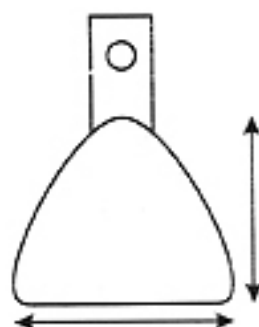

Number	Size	mm.	mm.
29-053-L66	L	86	64
29-054-L67	NL	70	64
29-055-L68	M	73	60
29-056-L69	S	70	57

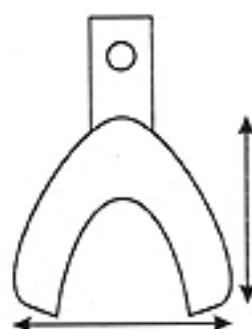

29-052-U64

29-051-U63

29-050-U62

29-049-U61

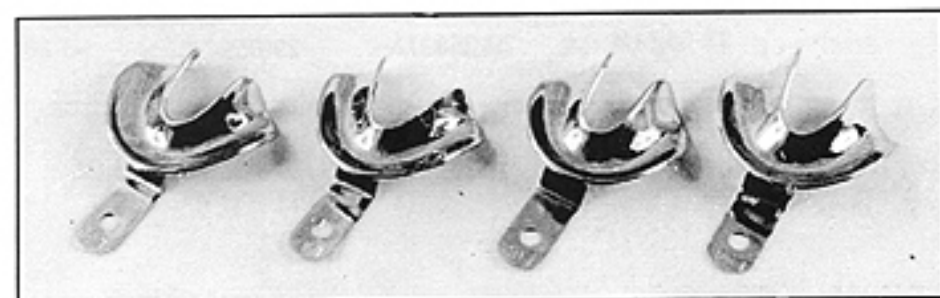

29-056-L69

29-055-L68

29-054-L67

29-053-L66

STAINLESS STEEL IMPRESSION TRAYS
 ABDRUCKKLOFFEL AUS EDELSTAHL
 CUBETAS PARA DE ACERO INOXIDABLE



REGULAR (Rim Lock)

29-007-44
 Set of 6 Pieces

UPPER

Numbers	Size	mm.	mm.
29-057-U1	S	55	41
29-058-U2	M	62	46
29-059-U3	L	63	48

LOWER

Numbers	Size	mm.	mm.
29-060-L1	S	55	44
29-061-L2	M	63	52
29-062-L3	L	69	56

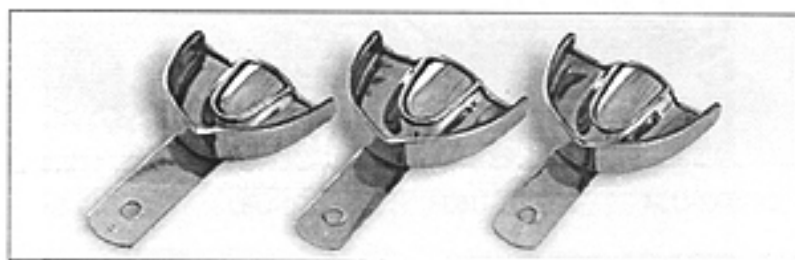
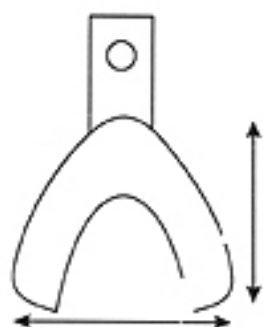
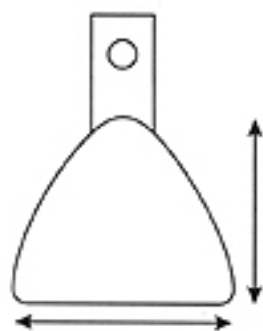

29-057-U1

29-058-U2

29-059-U3



29-060-L1

29-061-L2

29-062-L3



SUPPER (Rim Lock)

29-008-44
 Set of 10 Pieces

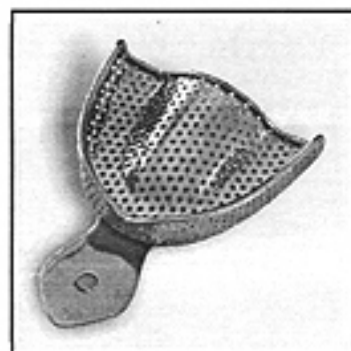

Numbers	Size	mm.	mm.
29-166-U1	XL	81	63
29-167-U2	L	74	60
29-168-U3	M	71	55
29-169-U4	NM	67	53
29-170-U5	S	65	51

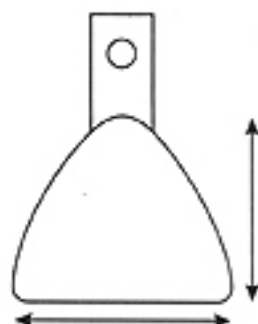

Numbers	Size	mm.	mm.
29-171-L1	XL	80	63
29-172-L2	L	78	59
29-173-L3	M	76	57
29-174-L4	NM	72	57
29-175-L5	S	69	50

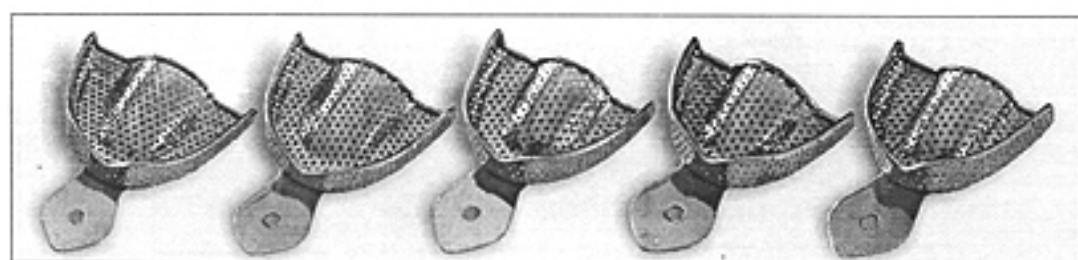
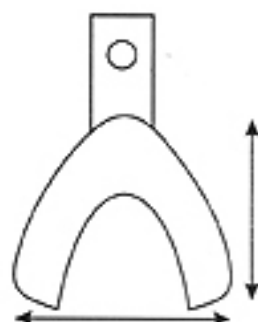

29-166-U1

29-167-U2

29-168-U3

29-169-U4

29-170-U5

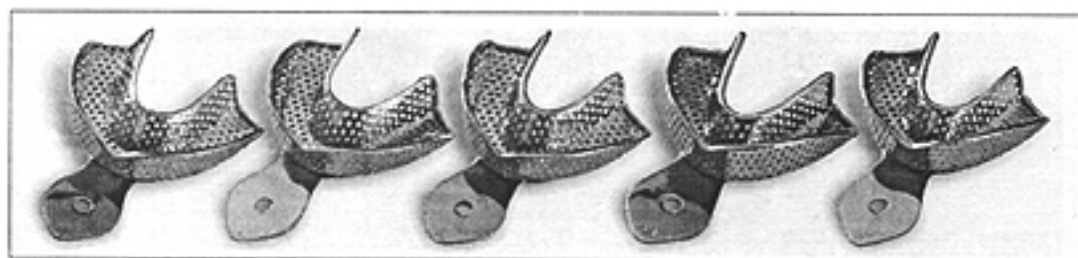

29-171-L1

29-172-L2

29-173-L3

29-174-L4

29-175-L5



REGULAR (Rim Lock)

29-009-44
 Set of 6 Pieces

UPPER

Numbers	Size	mm.	mm.
29-176-U1	S	55	41
29-177-U2	M	62	46
29-178-U3	L	63	48

LOWER

Numbers	Size	mm.	mm.
29-179-L1	S	55	44
29-180-L2	M	63	52
29-181-L3	L	69	56

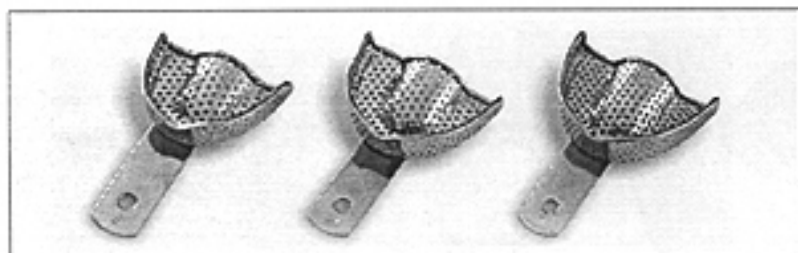
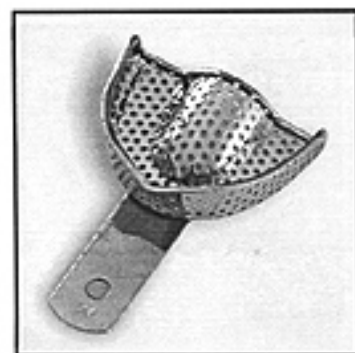
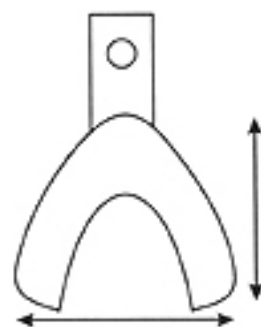
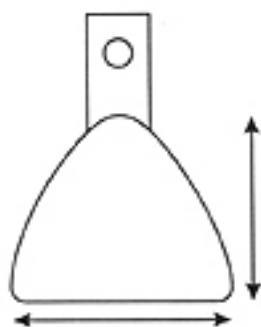

29-176-U1

29-177-U2

29-178-U3

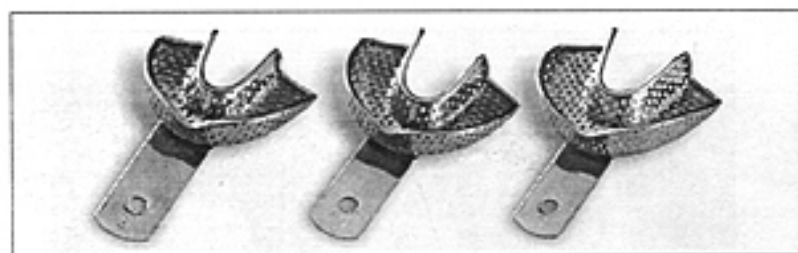

29-179-L1

29-180-L2

29-181-L3



STAINLESS STEEL IMPRESSION TRAYS
 ABDRUCKLOFFEL AUS EDELSTAHL
 CUBETAS PARA DE ACERO INOXIDABLE

29

REGULAR (Rim Lock)

29-010-00
 Set of 12 Pieces



Numbers	Size	mm.	mm.
29-087-U1	XXS	61	47
29-088-U2	XS	64	51
29-089-U3	S	66	53
29-090-U4	M	69	57
29-091-U5	L	71	60
29-092-U6	XL	73	62

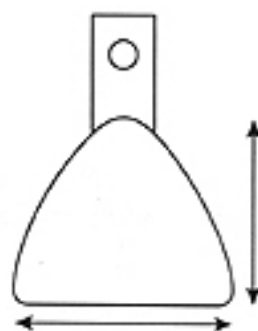

Numbers	Size	mm.	mm.
29-093-L1	XXS	55	47
29-094-L2	XS	60	49
29-095-L3	S	72	54
29-096-L4	M	75	57
29-097-L5	L	76	59
29-098-L6	XL	78	61

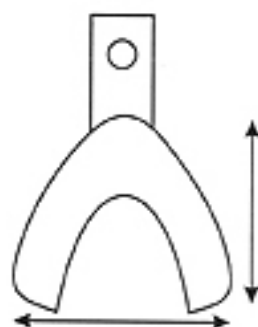

29-087-U1 29-088-U2 29-089-U3 29-090-U4 29-091-U5 29-092-U6

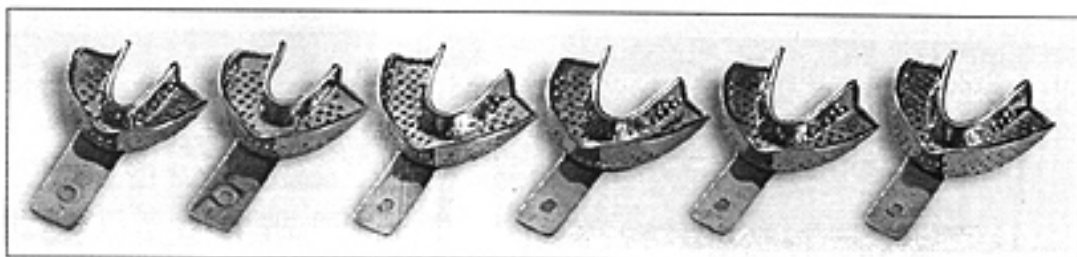

29-093-L1 29-094-L2 29-095-L3 29-096-L4 29-097-L5 29-098-L6



Crown and bridge work Impression trays

STAINLESS STEEL

29-011-00

►Set of 6 pieces

Number	Size
29-099-L6D	L
29-100-L4D	M
29-101-L2D	S

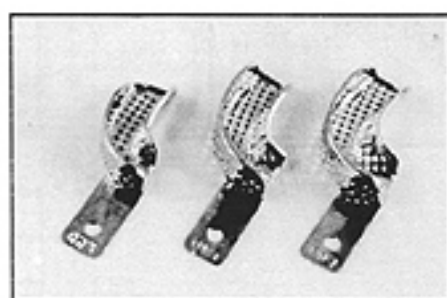

29-101-L2D 29-100-L4C 29-099-L6D

Number	Size
29-102-L6S	L
29-103-L4S	M
29-104-L2S	S

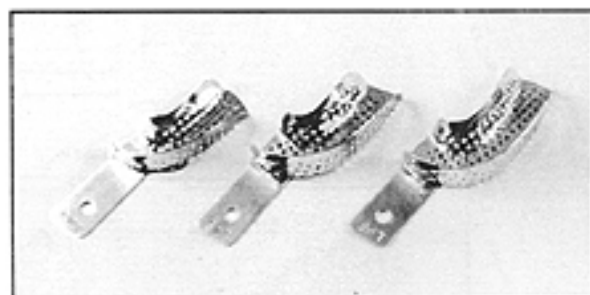

29-104-L2S 29-103-L4S 29-102-L6S

Number	Model
29-030-U1P	UPPER
29-031-L1P	LOWER

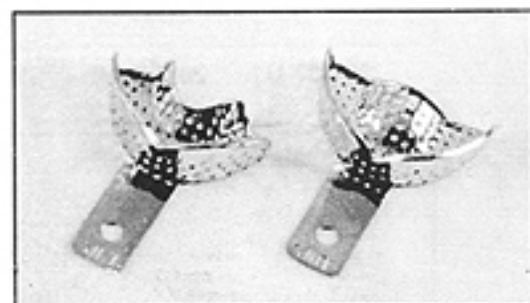

29-106-U1P 29-105-L1P



STAINLESS STEEL IMPRESSION TRAYS
 ABDRUCKLOFFEL AUS EDELSTAHL
 CUBETAS PARA DE ACERO INOXIDABLE

29

29-012-00

→ Set of 12 Pieces (Without Rim Lock)



Numbers	Size	mm.	mm.
29-107-U1	XXS	61	47
29-108-U2	XS	64	51
29-109-U3	S	66	53
29-110-U4	M	69	57
29-111-U5	L	71	60
29-112-U6	XL	73	62

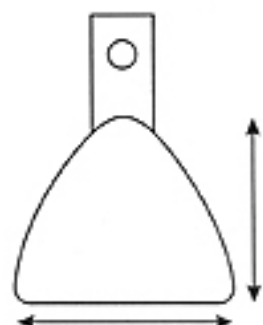

Numbers	Size	mm.	mm.
29-113-L1	XXS	55	47
29-114-L2	XS	60	49
29-115-L3	S	72	54
29-116-L4	M	75	57
29-117-L5	L	76	59
29-118-L6	XL	78	61

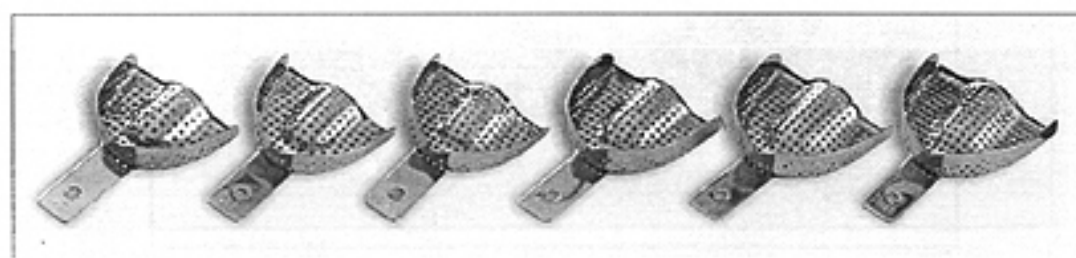
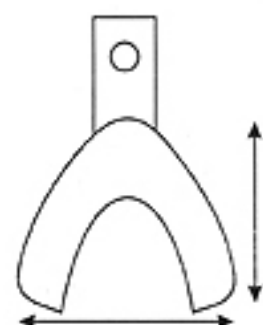

29-107-U1 29-108-U2 29-109-U3 29-110-U4 29-111-U5 29-112-U6

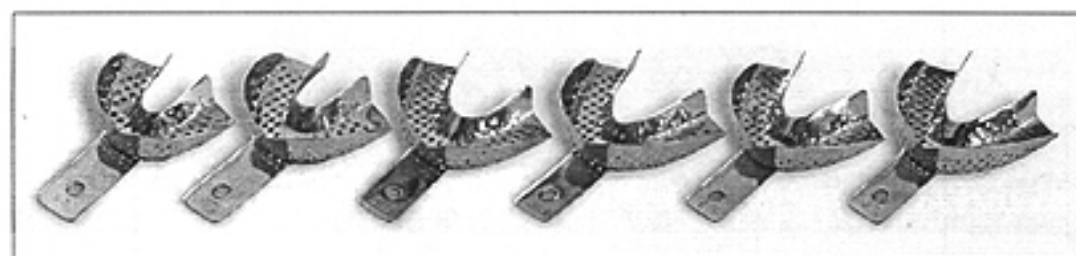

29-113-L1 29-114-L2 29-115-L3 29-116-L4 29-117-L5 29-118-L6



DEPRESSED ANTERIOR (Rim Lock)

29-013-00

Set of 6 pieces

Numbers	Size	mm.	mm.
29-119-U7	L	81	67
29-120-U4	M	71	64
29-121-U1	S	70	57

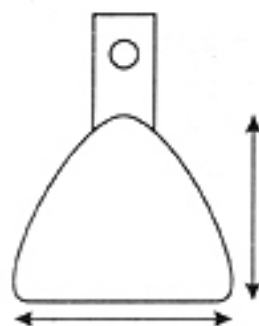

Numbers	Size	mm.	mm.
29-122-L22	L	81	60
29-123-L21	M	79	57
29-124-L20	S	76	54

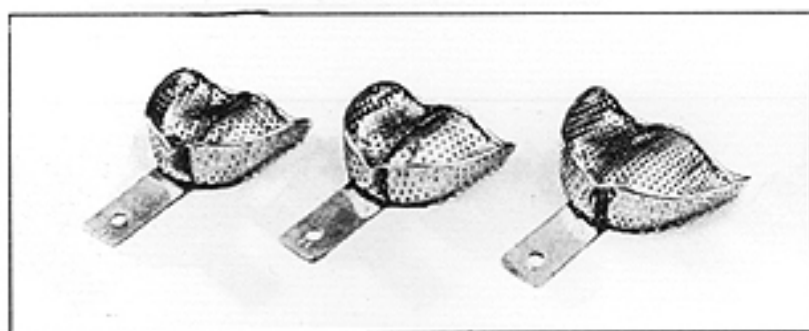
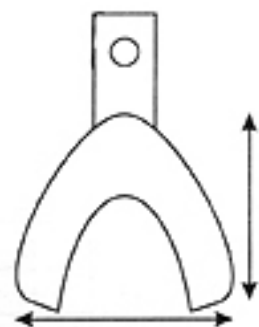

29-121-U1

29-120-U4

29-119-U7

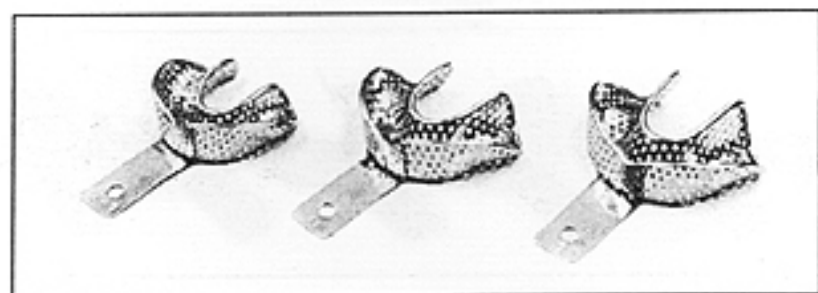

29-124-L20

29-123-L21

29-122-L22



STAINLESS STEEL IMPRESSION TRAYS
 ABDRUCKLOFFEL AUS EDELSTAHL
 CUBETAS PARA DE ACERO INOXIDABLE

29

DENTURE / EDENTOLOUS



29-014-00
 Set of 8 pieces

Numbers	Size	mm.	mm.
29-125-U64	L	79	70
29-126-U63	M	76	67
29-127-U62	NM	70	64
29-128-U61	S	73	60

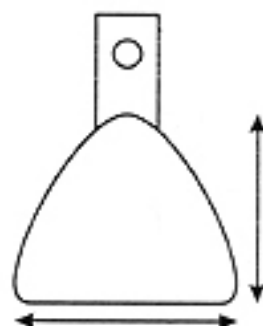

Numbers	Size	mm.	mm.
29-129-L69	L	86	64
29-130-L68	NL	73	60
29-131-L67	M	70	64
29-132-L66	S	70	57

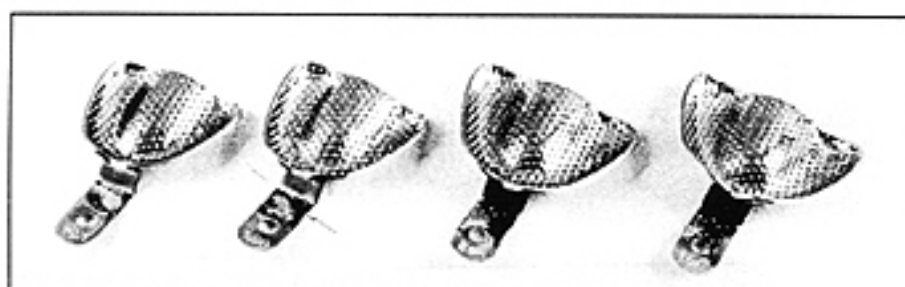
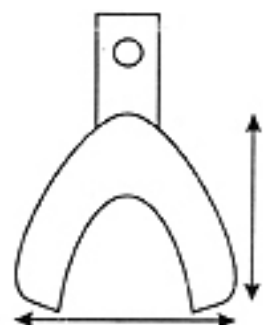

29-128-U61

29-127-U62

29-126-U63

29-125-U64



29-132-L66

29-131-L67

29-130-L68

29-129-L69

M. A. ARAIN & BROTHERS (PVT.) LTD.

347



EHRICKE (Non Perforated)

Numbers	Size
29-185-UO1	UO1
29-186-UO2	UO2
29-187-UO3	UO3



Numbers	Size
29-188-UU1	UU1
29-189-UU2	UU2
29-190-UU3	UU3

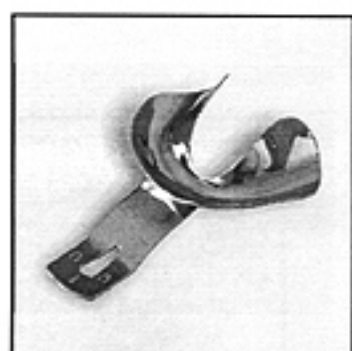

Numbers	Size
29-191-BO0	BO0
29-192-BO1	BO1
29-193-BO2	BO2
29-194-BO3	BO3
29-195-BO4	BO4



Numbers	Size
29-196-BU0	BU0
29-197-BU1	BU1
29-198-BU2	BU2
29-199-BU3	BU3
29-200-BU4	BU4



Numbers	Size
29-201-PO1	PO1
29-202-PO2	PO2
29-203-PO3	PO3



Numbers	Size
29-204-PU1	PU1
29-205-PU2	PU2
29-206-PU3	PU3





STAINLESS STEEL IMPRESSION TRAYS
 ABDRUCKLOFFEL AUS EDELSTAHL
 CUBETAS PARA DE ACERO INOXIDABLE

29

EHRICKE (Perforated)

Numbers	Size
29-207-UO1	UO1
29-208-UO2	UO2
29-209-UO3	UO3



Numbers	Size
29-210-UU1	UU1
29-211-UU2	UU2
29-212-UU3	UU3



Numbers	Size
29-213-BO0	BO0
29-214-BO1	BO1
29-215-BO2	BO2
29-216-BO3	BO3
29-217-BO4	BO4



Numbers	Size
29-218-BU0	BU0
29-219-BU1	BU1
29-220-BU2	BU2
29-221-BU3	BU3
29-222-BU4	BU4



Numbers	Size
29-223-PO1	PO1
29-224-PO2	PO2
29-225-PO3	PO3



Numbers	Size
29-226-PU1	PU1
29-227-PU2	PU2
29-228-PU3	PU3



STAINLESS STEEL IMPRESSION TRAYS
 ABDRUCKKLOFFEL AUS EDELSTAHL
 CUBETAS PARA DE ACERO INOXIDABLE





NEW

EDENTULOUS

29-018-44

Set of 11 Pieces (Without Rim Lock)

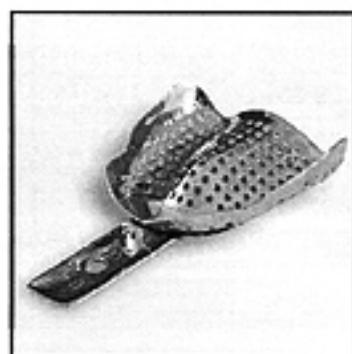
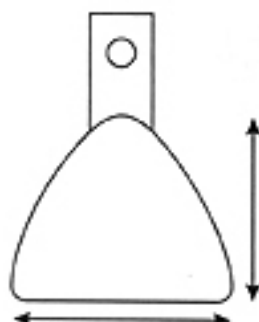
Numbers	Size	mm.	mm.
29-230-U1	XXS	60	50
29-231-U2	XS	64	54
29-232-U3	S	68	58
29-233-U4	M	70	60
29-234-U5	L	78	64



Numbers	Size	mm.	mm.
29-235-L1	XXS	60	54
29-236-L2	XS	67	55
29-237-L3	S	70	56
29-238-L4	M	74	58
29-239-L5	L	76	60
29-240-L6	XL	80	62

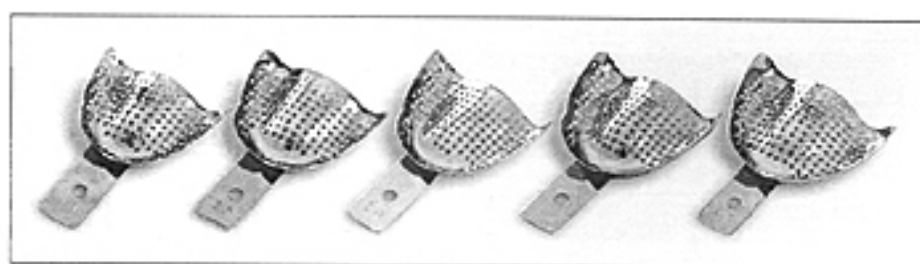
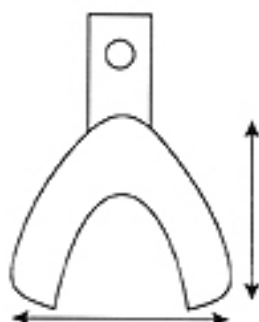

29-230-U1 29-231-U2 29-232-U3 29-233-U4 29-234-U5



29-235-L1 29-236-L2 29-237-L3 29-238-L4 29-239-L5 29-240-L6

Department

30

TRAYS AND BOWLS
TABLETEN UND BECHER
BANDEJAS PARA BUCALES



DEPARTMENT NO. 30

FROM
PAGE#

351

TO
PAGE#

359

INSTRUMENTS CATEGORY

TRAYS AND BOWLS
TABLETEN UND BECHER
BANDEJAS PARA BUCALES



ALCOHOL BURNER
SPIRITUS LAMPE
LAMPARA DE ALCOHOL

30

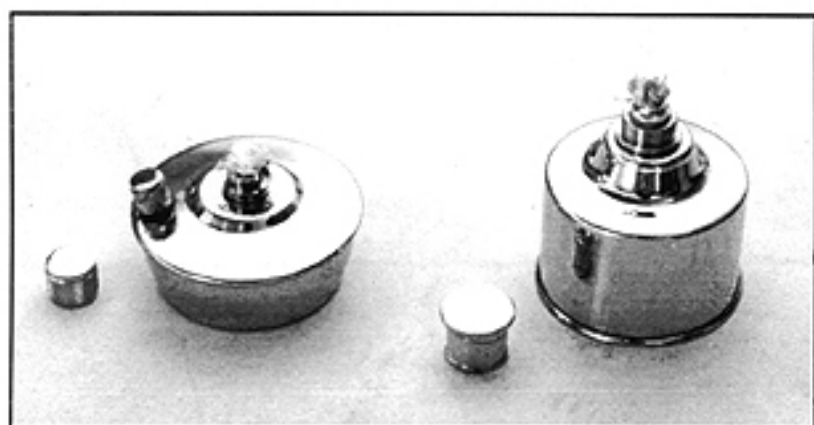

30-001-00
4 oz

30-002-00
4 oz
6 oz

TRAYS AND BOWLS
 TABLETEN UND BECHER
 BANDEJAS PARA BUCALES



ARAIN



30-003-10 (10 cm)
 30-004-12 (12 cm)
 30-005-15 (15 cm)
 30-006-20 (20 cm)
 30-007-25 (25 cm)
 Lotion Bowl

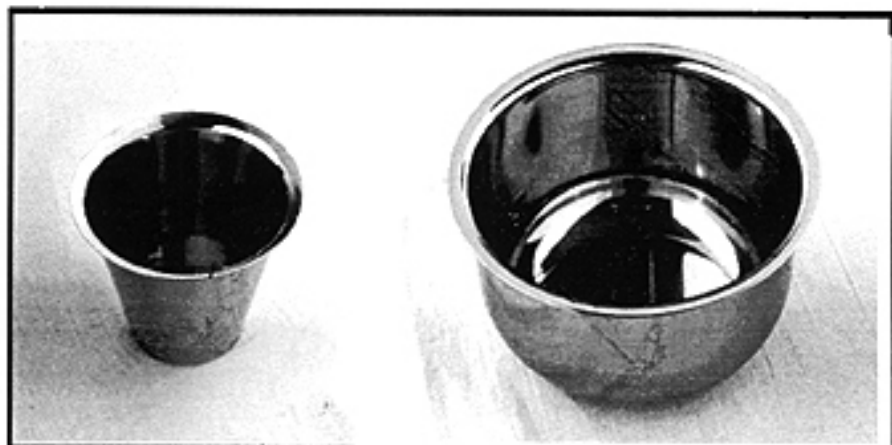
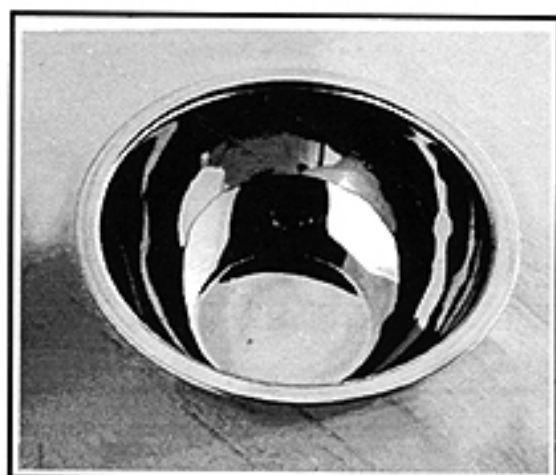

30-008-00 (50 cc)
 30-009-00 (100 cc)
 Medicine Cup

30-010-00 (80x50 mm)
 Iodine Cup



TRAYS AND BOWLS
TABLETEN UND BECHER
BANDEJAS PARA BUCALES

30

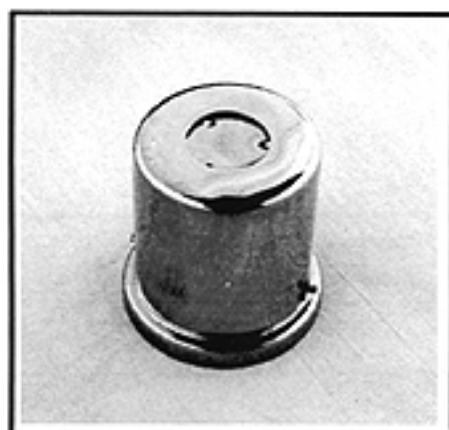

30-011-00
Cotton Wool Holder

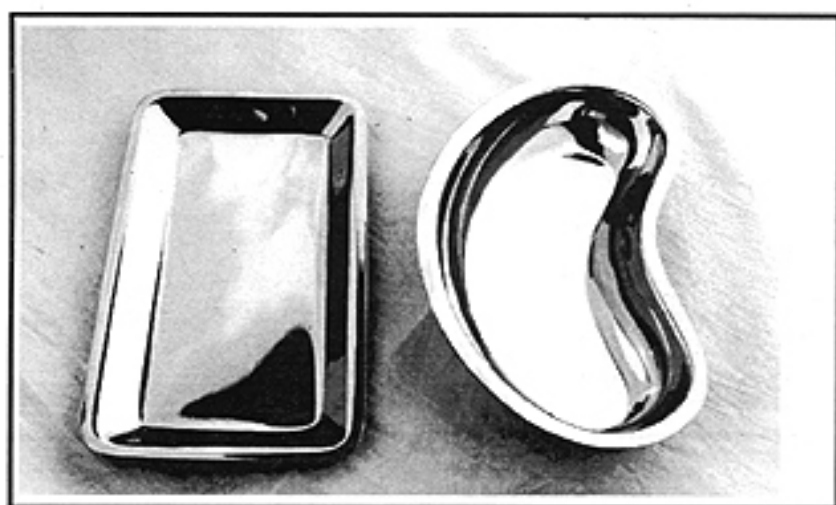

	L	W	H
30-012-00	9.2	5.4	1
30-013-00	15	10	1
30-014-00	18.5	10.5	1
30-015-00	19	10	1.5
30-016-00	20	10	1
30-017-00	20	15	1
30-018-00	25	15	1
30-019-00	28	19	2
30-020-00	29	19	1

Instrument Tray

30-021-12	(12 cm)
30-022-15	(15 cm)
30-023-20	(20 cm)
30-024-25	(25 cm)
30-025-30	(30 cm)

Kidney Tray

HEAD LAMPS FOR LOW VOLTAGE CURRENT
STIRNLAMPEN FÜR SCHWACHSTROM
LAMPARAS FRONTALES PARA CORRIENTE DE BAJA TENSION

ARAIN

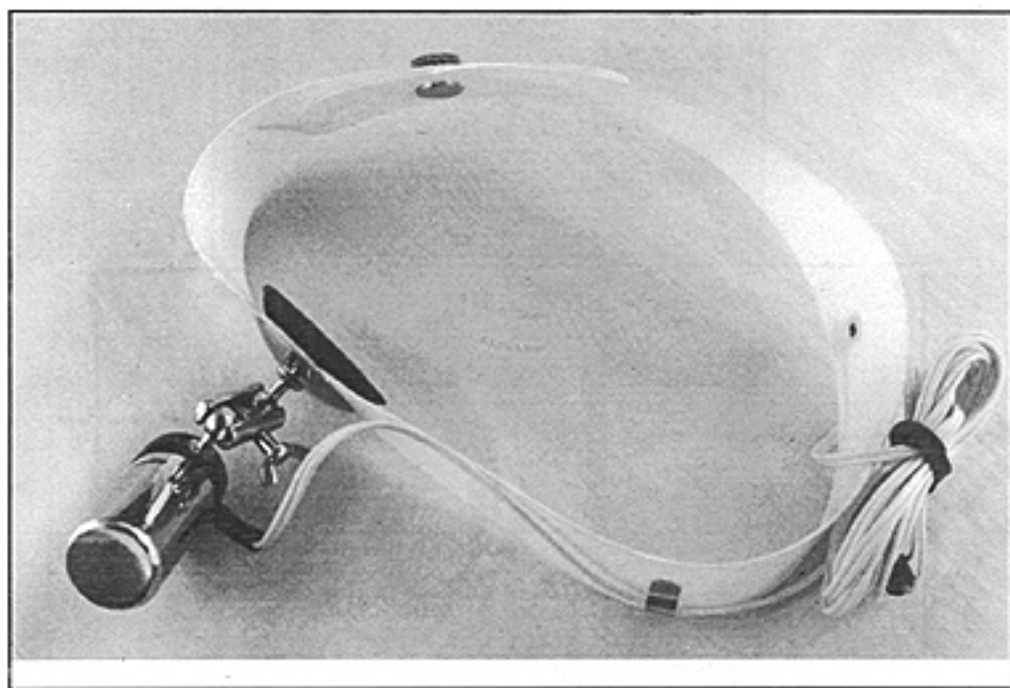
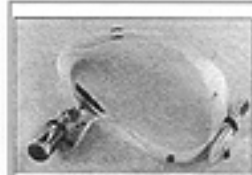

30-026-00
Mod. Matin



ARAIN

HEAD MIRRORS
STIRNSPIEGEL
ESPEGOS FRONTALES

30

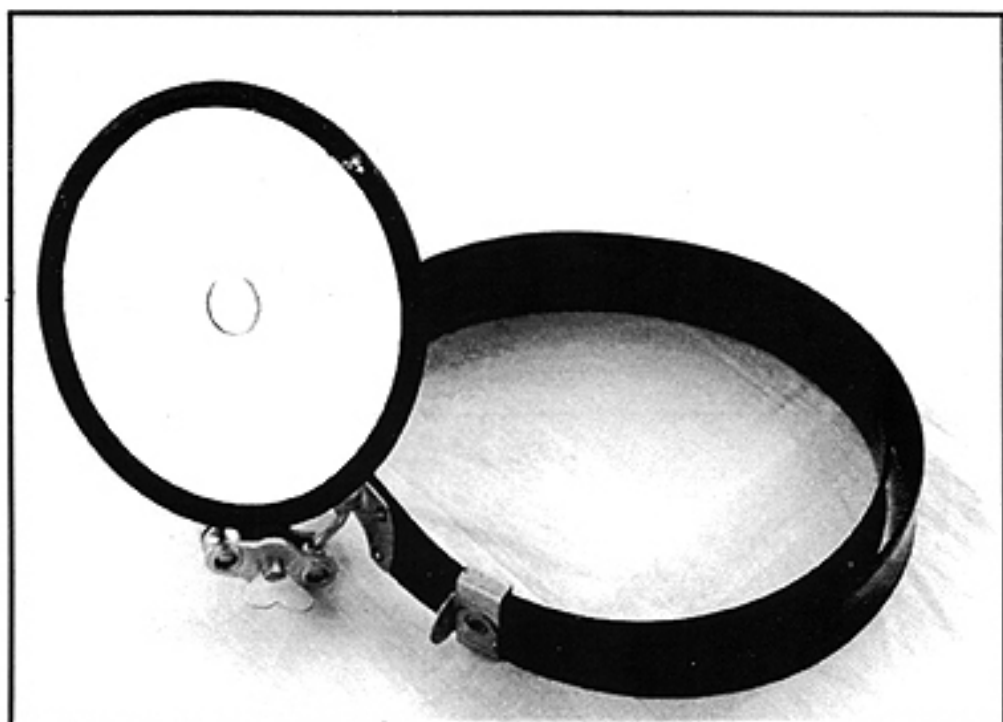

30-027-00
Head Mirrors



30-028-01



30-028-02



30-028-03



30-028-04



30-028-05



30-028-06

NAPKIN HOLDERS

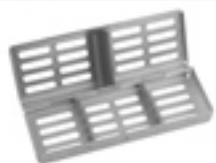

TRAYS
TABLETEN
BONDEJAS

30



Cassette Trays with fixed lid

30-060-00	180 x 60 x 22 mm
30-061-00	180 x 140 x 22 mm
30-062-00	280 x 184 x 28 mm



Cassette Trays with detachable lid

30-065-00	180 x 70 x 35 mm
30-066-00	180 x 110 x 35 mm
30-067-00	180 x 145 x 35 mm
30-068-00	290 x 180 x 35 mm

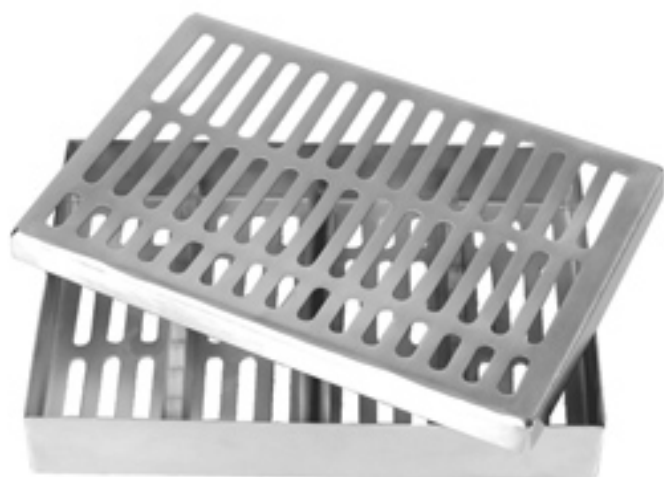

Cassette Trays

30-070-00	180 x 60 x 20 mm
30-071-00	180 x 125 x 20 mm
30-072-00	200 x 140 x 30 mm

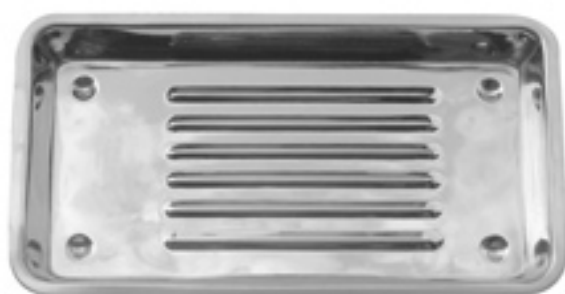

30-074-00 200 x 115 x 20 mm



FILM HANGERS
FILM KLAMMER

30



30-030-00
Film Holder

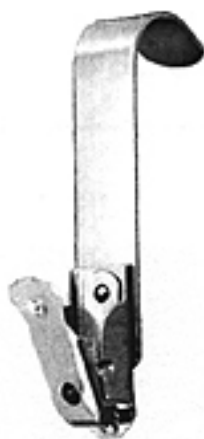

30-029-00
Radiography Clip

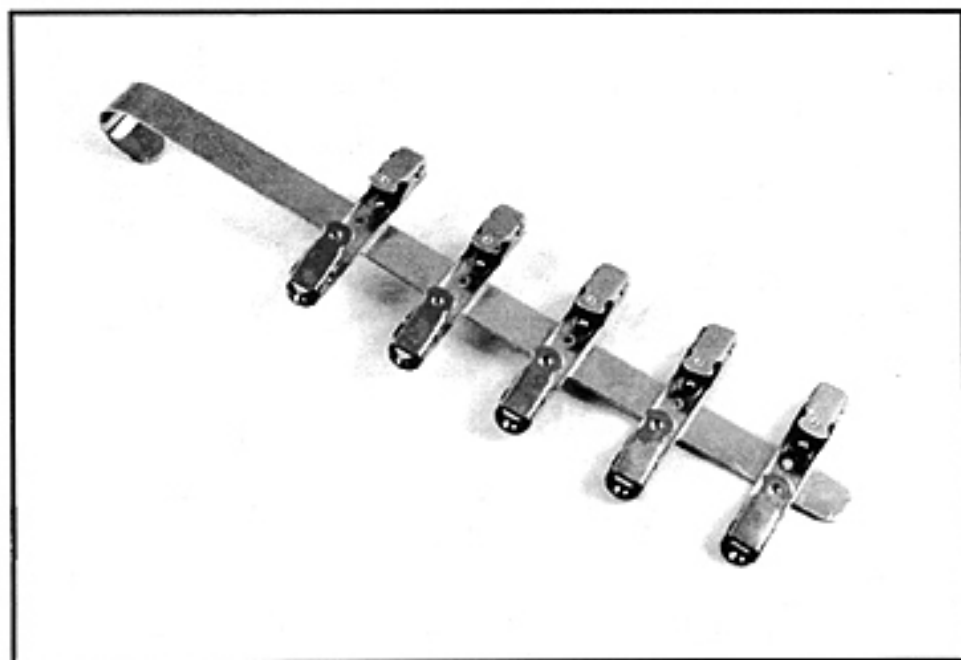

30-031-00 (With 14 Clips)
30-032-00 (With 10 Clips)
30-033-00 (With 6 Clips)
Film Hangers

Department

31

ORTHODONTICS PLIERS
ORTHODONTIE ZANGEN
ALICATES DE ORTODONCIA

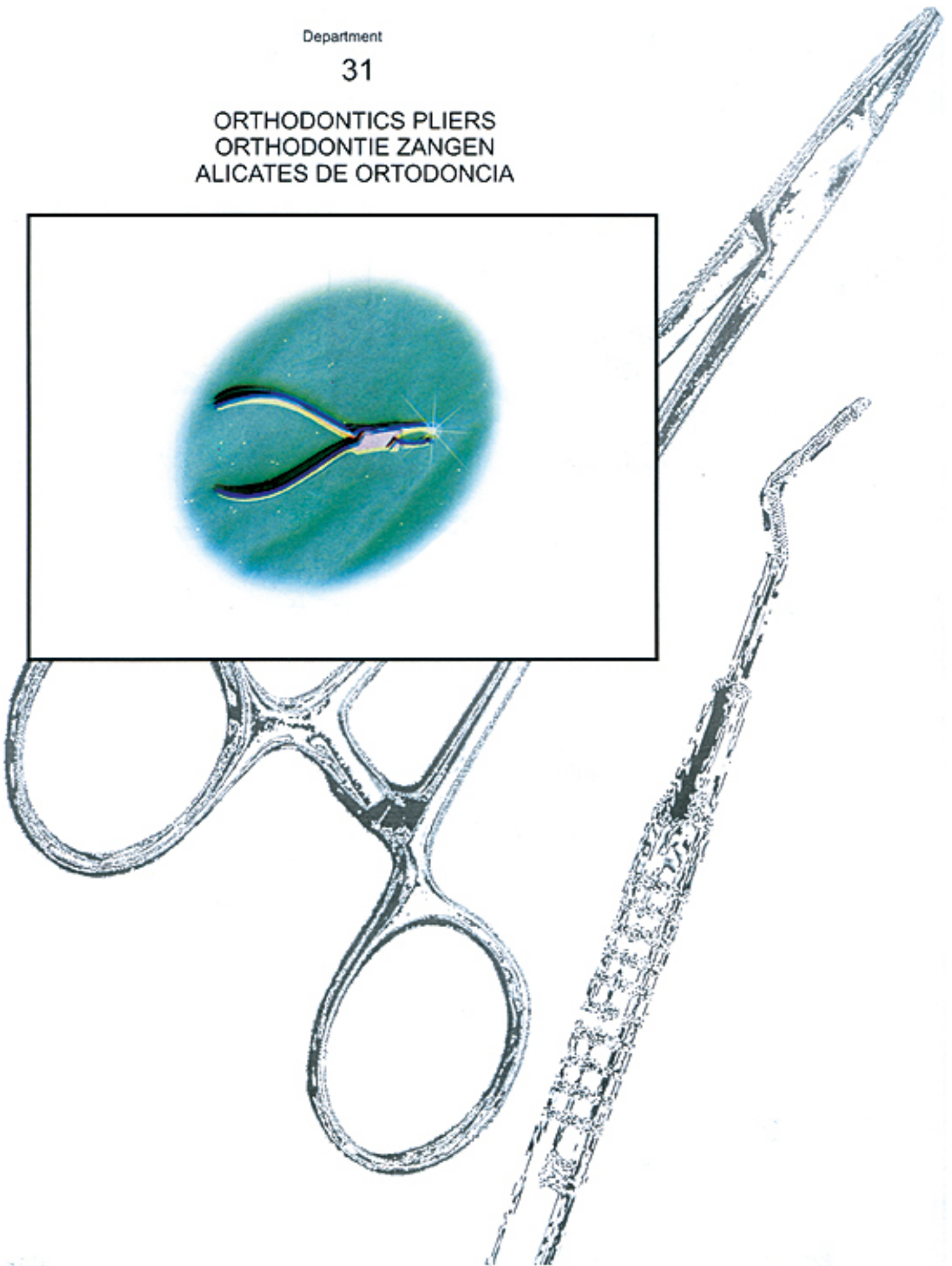
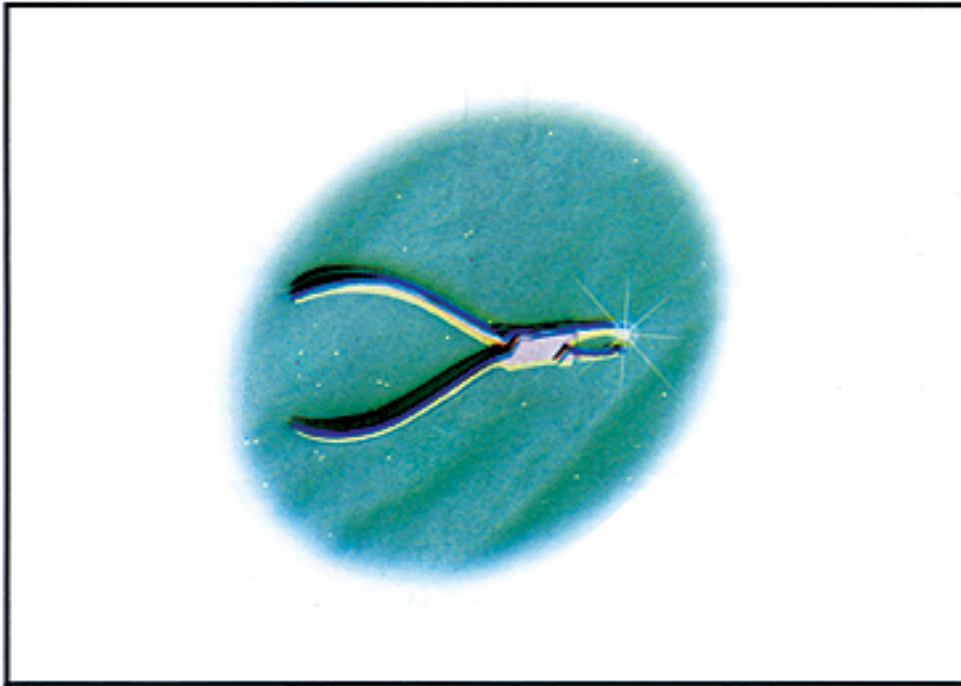

DEPARTMENT NO. 31

FROM
PAGE#

360

TO
PAGE#

375

INSTRUMENTS CATEGORY

ORTHODONTICS PLIERS
ORTHODONTIE ZANGEN
ALICATES DE ORTODONCIA

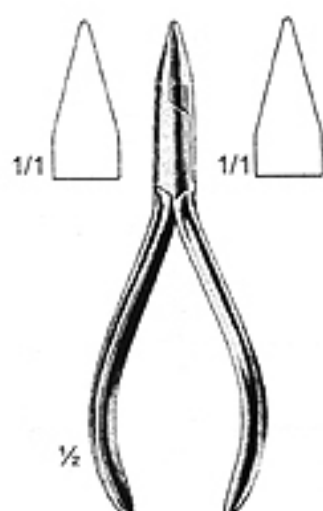

31-001-13
 13.5 cm

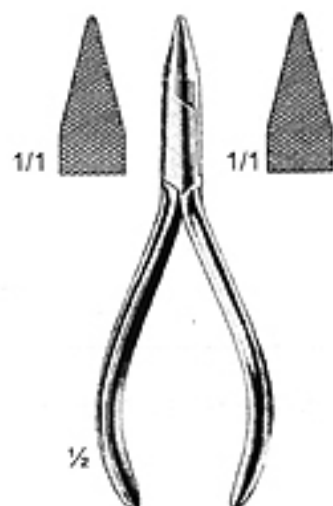

31-002-13
 13.5 cm
 Flat Nose Pliers

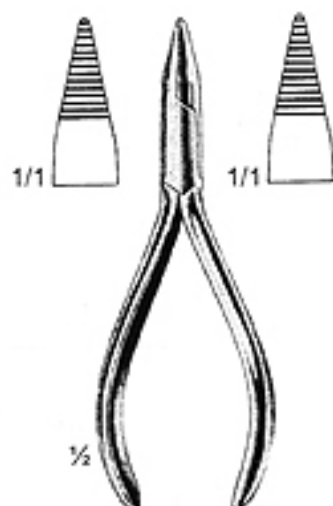

31-003-13
 13.5 cm

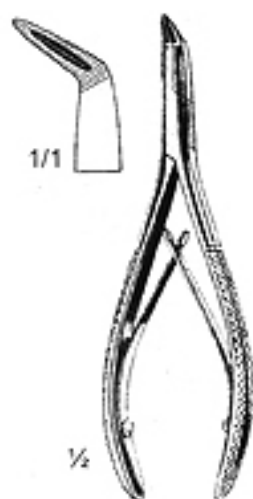

31-004-13
 13.5 cm
 Stieglitz

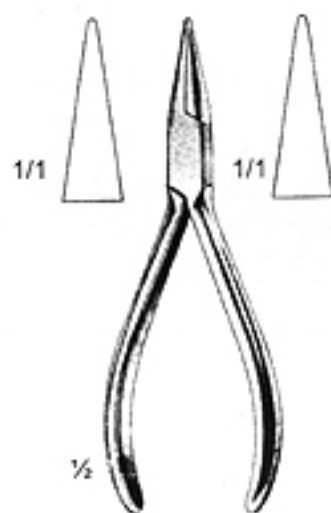

31-005-14
 14 cm

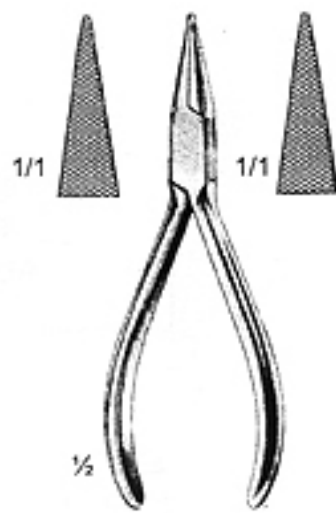

31-006-14
 14 cm



ARAIN

ORTHODONTICS PLIERS
ORTHODONTIE ZANGEN
ELICATES DE ORTODONCIA

31



31-007-14
14 cm

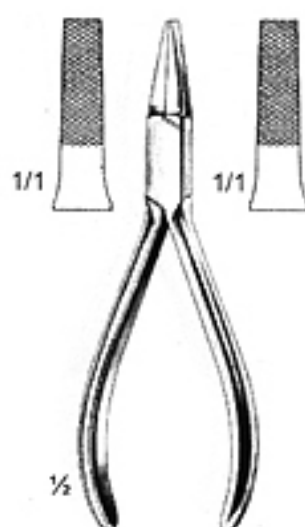

31-008-14
14 cm



31-009-13
13.5 cm

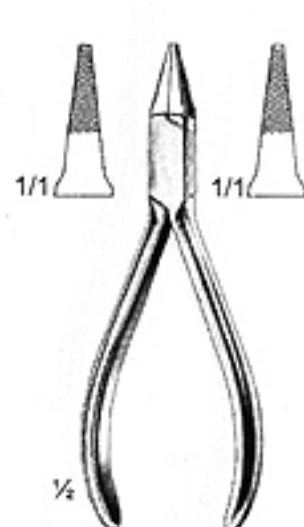

31-010-13
13 cm

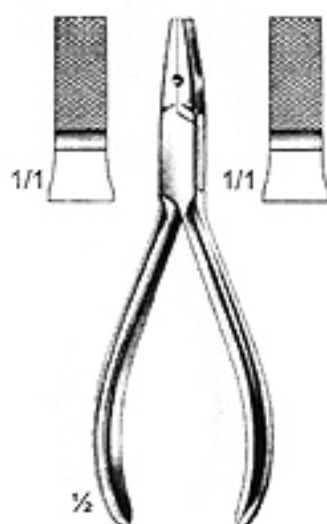

31-011-14
14 cm

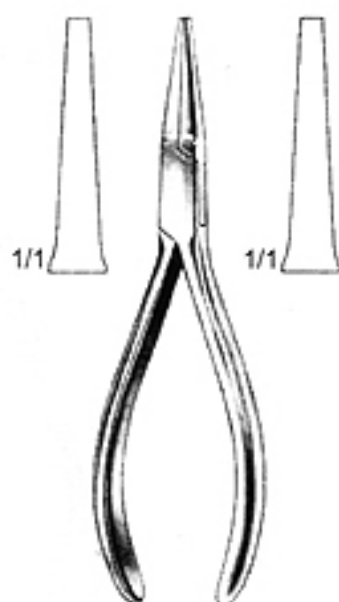

31-012-16
16 cm

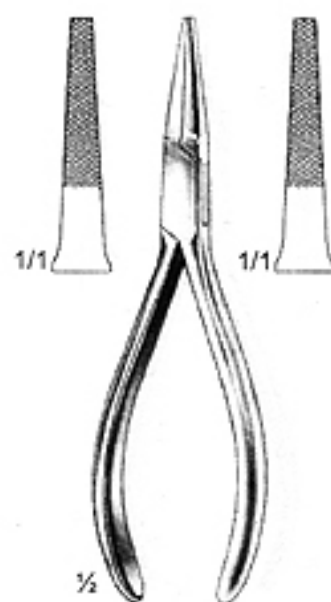

31-013-16
16 cm

Langbeck

ORTHODONTICS PLIERS
 ORTHODONTIE ZANGEN
 ELICATES DE ORTODONCIA

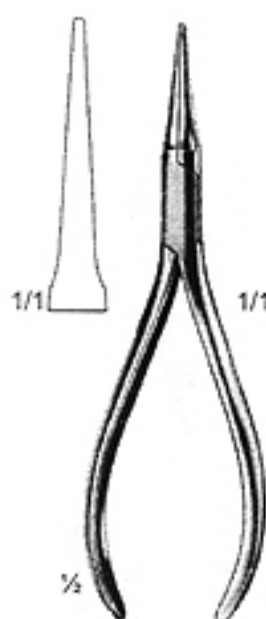
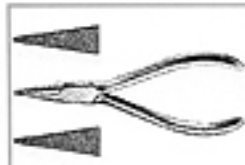
31-014-16
16.5 cm

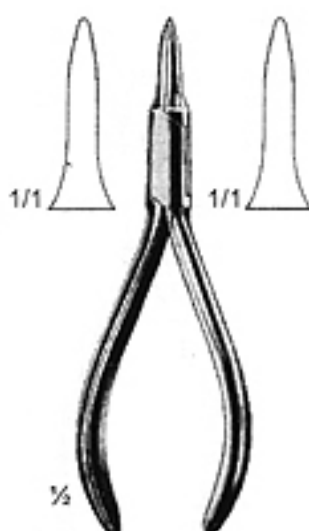

31-015-14
14 cm

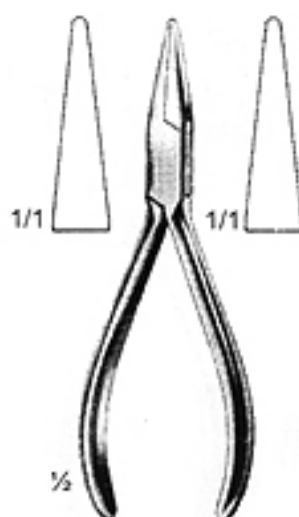

31-016-14
14 cm

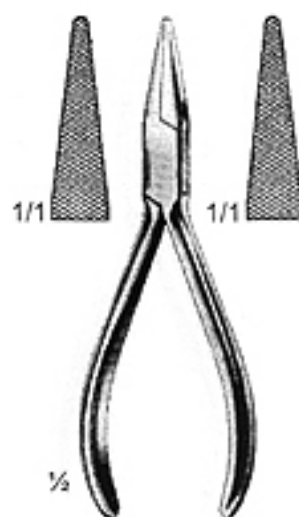

31-017-14
14 cm

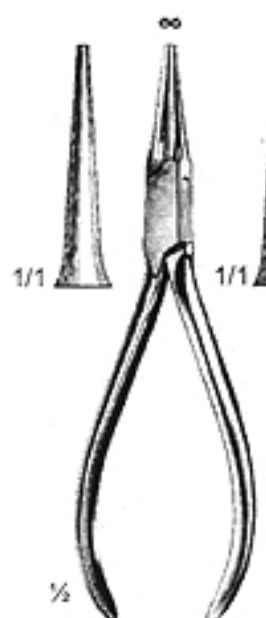

31-018-15
15.5 cm

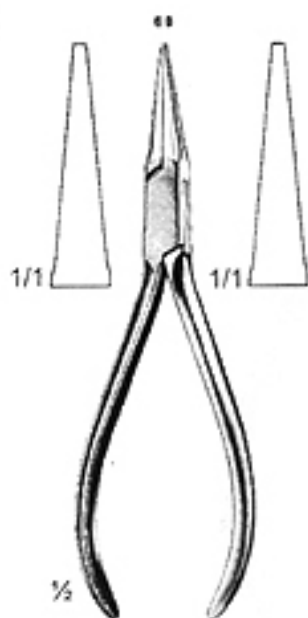

31-019-15
15.5 cm

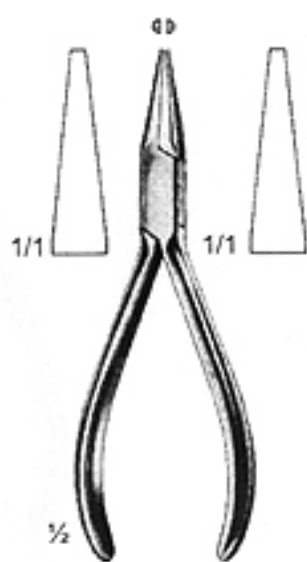

31-020-14
14 cm

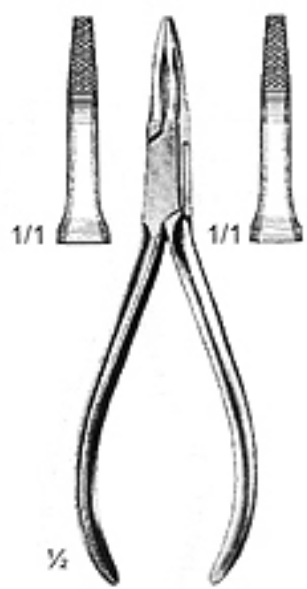

31-021-15
15.5 cm
Fischer

Langbeck



ARAIN

ORTHODONTICS PLIERS
ORTHODONTIE ZANGEN
ELICATES DE ORTODONCIA

31

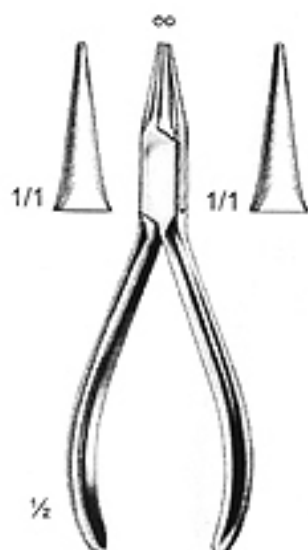

31-022-14
14 cm

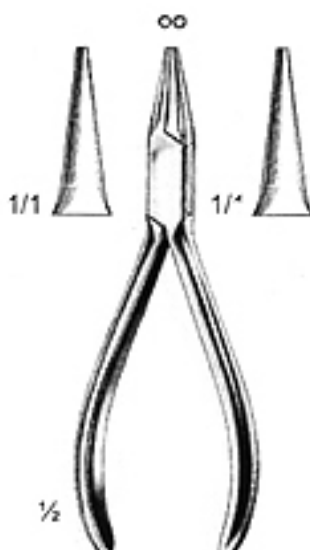

31-023-14
14 cm
Round Nose Pliers

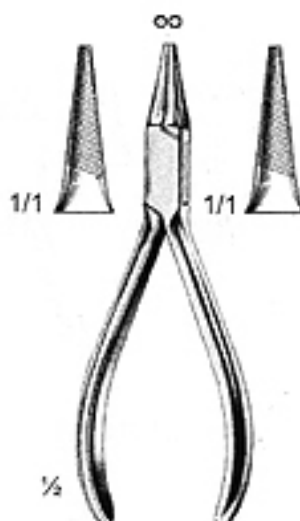

31-024-14
14 cm



31-025-14
14 cm



31-026-13
13 cm



31-027-13
13 cm



305
31-028-13
13 cm
Oliver

Angle

ORTHODONTICS PLIERS
 ORTHODONTIE ZANGEN
 ELICATES DE ORTODONCIA



ARAIN

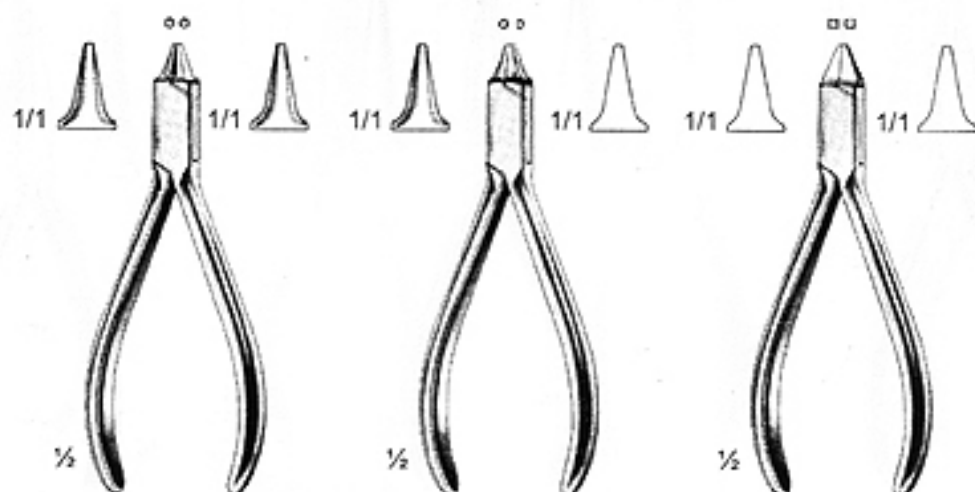

31-029-12.5
12.5 cm

139
31-030-12.5
12.5 cm
Angle

31-031-12.5
12.5 cm
Adams

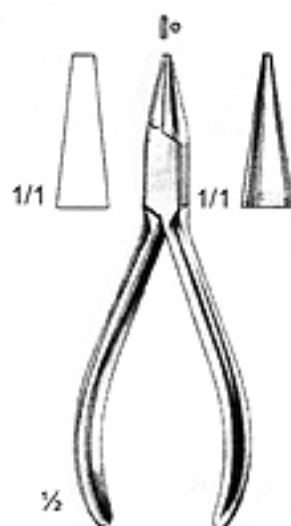

31-032-13
13 cm

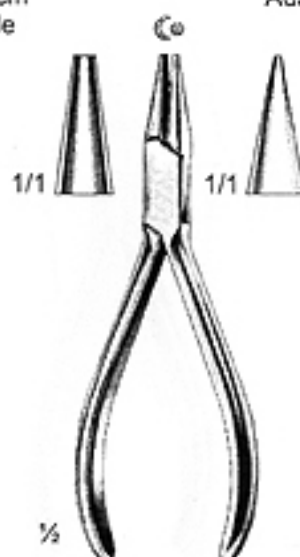

31-033-14
14 cm
Schwarz



ARAIN

ORTHODONTICS PLIERS
ORTHODONTIE ZANGEN
ELICATES DE ORTODONCIA

31

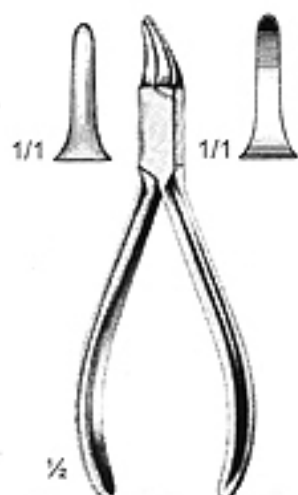

137
31-034-13
13.5 cm
Gordon

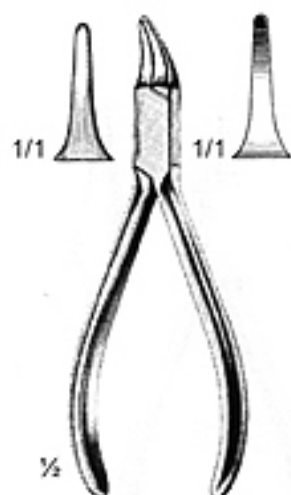

31-035-13
13.5 cm
USA Modell

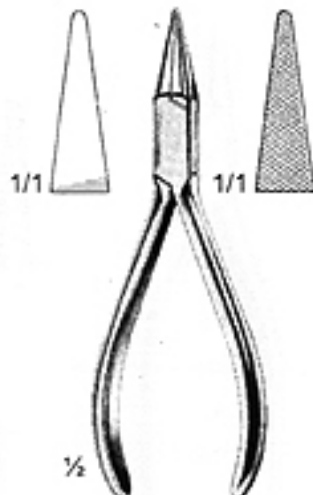

136
31-036-13
13.5 cm
Goslee

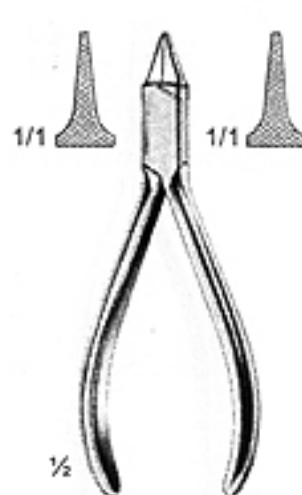

31-037-13
13 cm
Frevert

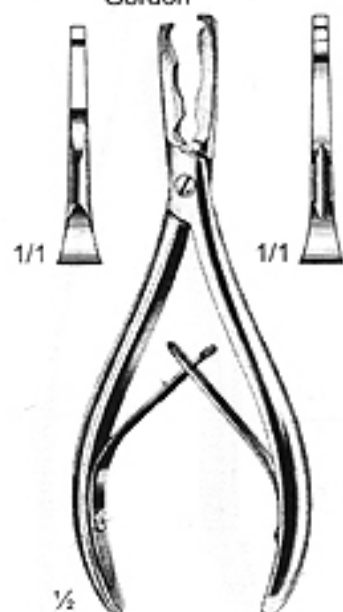

31-038-16
16.5 cm
Tryfus

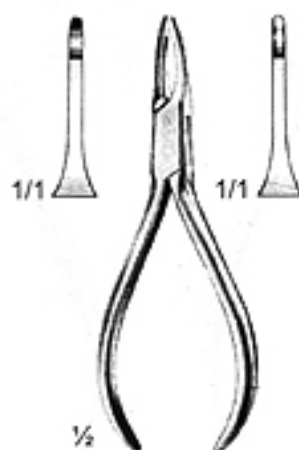

114
31-039-12
12 cm
Johnson



115
31-040-13
13 cm
Reynolds

ORTHODONTICS PLIERS
 ORTHODONTIE ZANGEN
 ELICATES DE ORTODONCIA



ARAIN



139
 31-041-16
 16 cm



134
 31-042-16
 16 cm

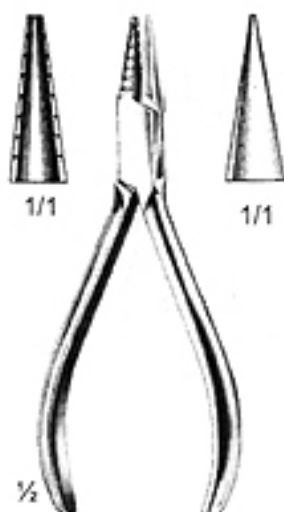

31-043-14
 14 cm
 Schwarz



31-044-11
 11.5 cm



200
 31-045-13
 13 cm



100
 31-046-14
 14 cm



31-047-21
 21 cm
 Malottky

Mc Kellops

Aderer



ARAIN

ORTHODONTICS PLIERS
ORTHODONTIE ZANGEN
ALICATES DE ORTODONCIA

31

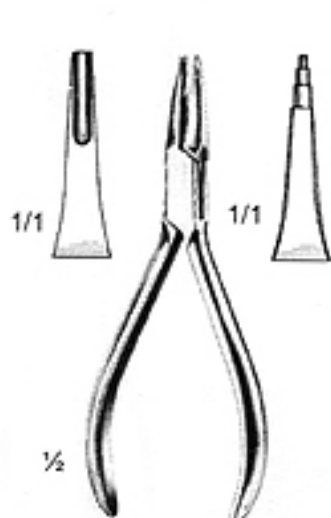

31-048013
13.5 cm
Tweed



31-049-14
14 cm
Andresen



31-050-13
13 cm
Nance

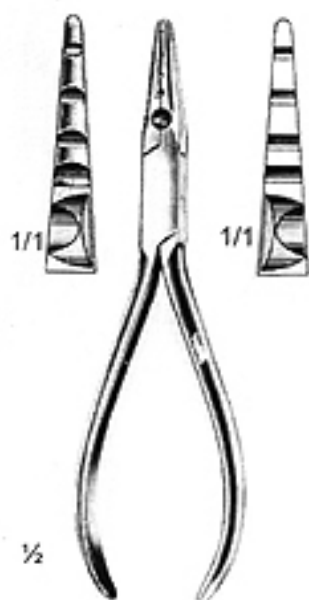

31-051-16
16 cm

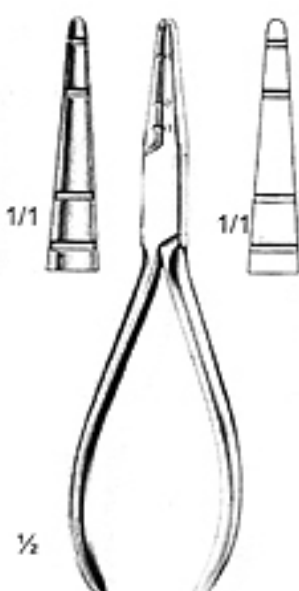

31-052-16
16 cm
Jelenko

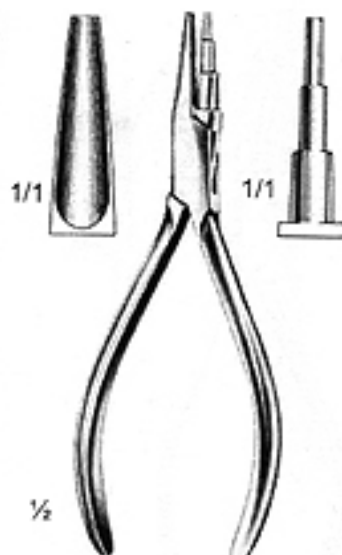

31-053-15
15 cm

ORTHODONTICS PLIERS
 ORTHODONTIE ZANGEN
 ALICATES DE ORTODONCIA

ARAIN

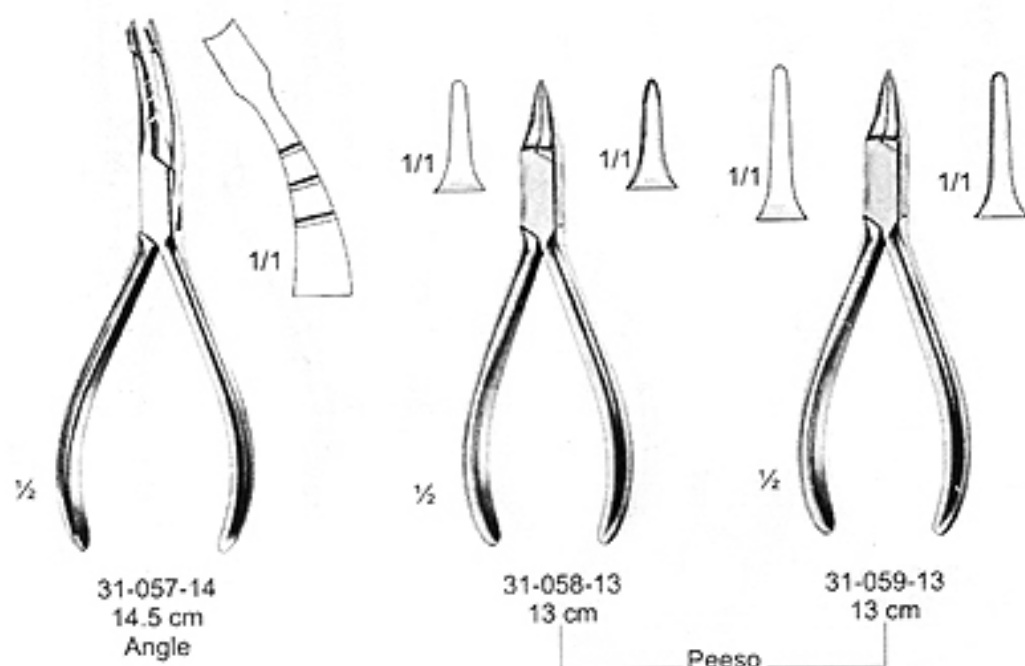
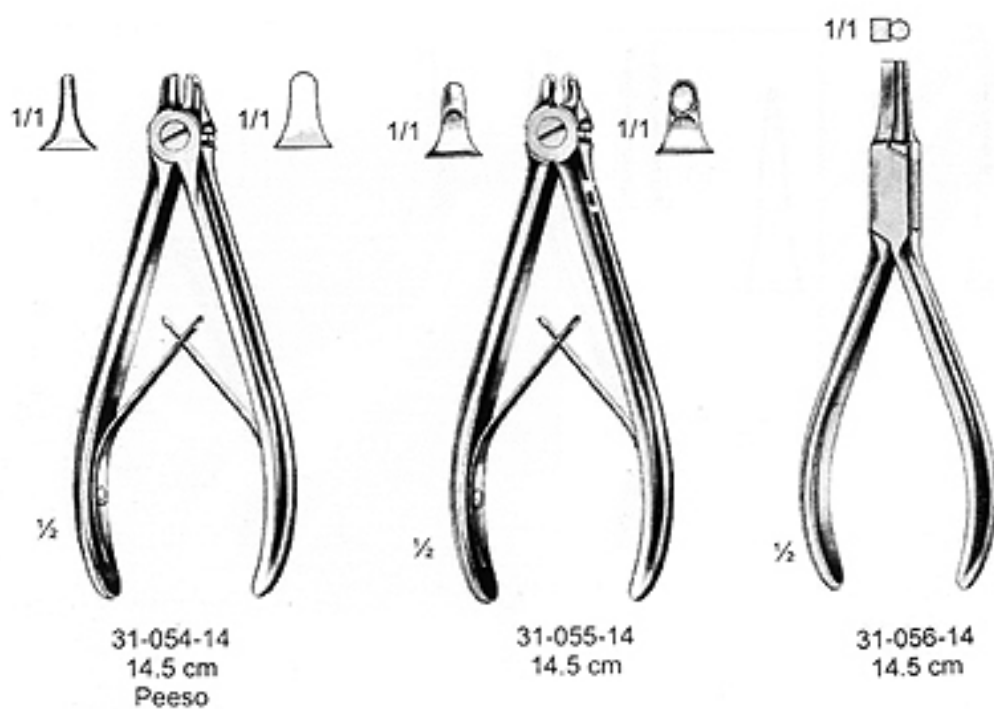



ORTHODONTICS PLIERS
ORTHODONTIE ZANGEN
ALICATES DE ORTODONCIA

31



31-060-16
16 cm
Baade



255
31-061-14
14 cm
Furrer



31-062-14
14 cm

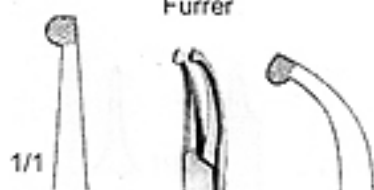

31-063-13
13.5 cm

How

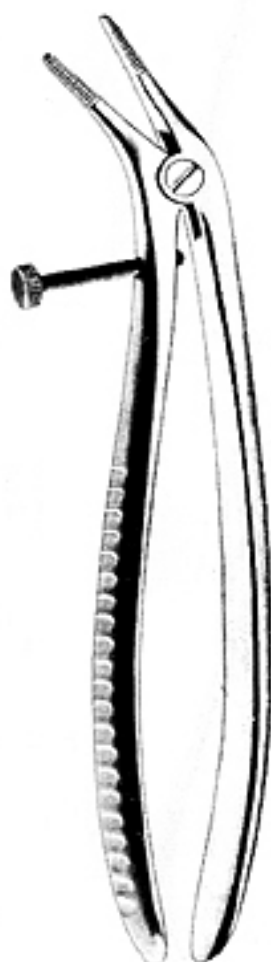

31-064-12
12 cm

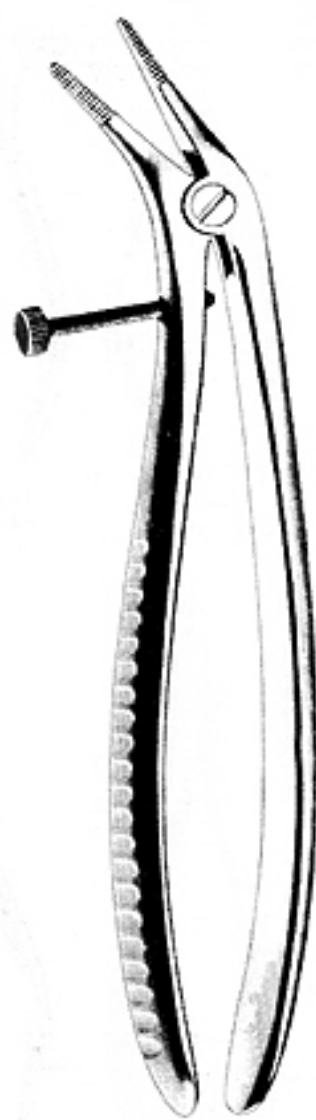

31-065-15
15 cm
Bohm

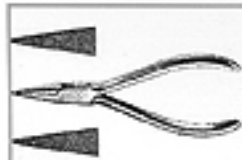

½

31-066-14
 14.5 cm
 Triplex



½

31-067-15
 15 cm
 Universal



31-068-14
 14.5 cm

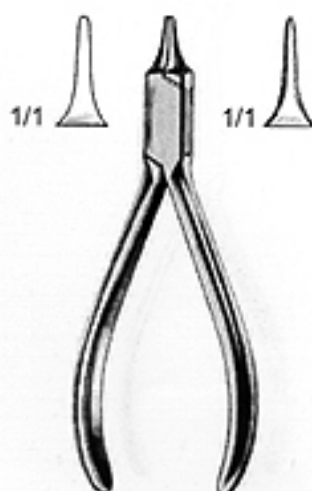

31-069-13
 13 cm
 Waldron



ARAIN

ORTHODONTICS PLIERS
ORTHODONTIE ZANGEN
ALICATES DE ORTODONCIA

31

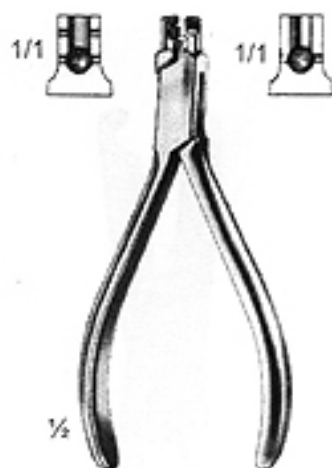

31-070-12
12 cm
Schwarz



31-071-13
13 cm
Schwarz

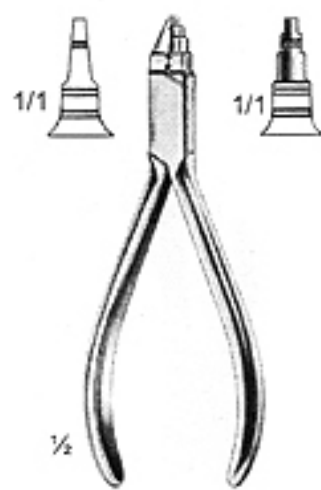

31-072-13
13 cm
Young

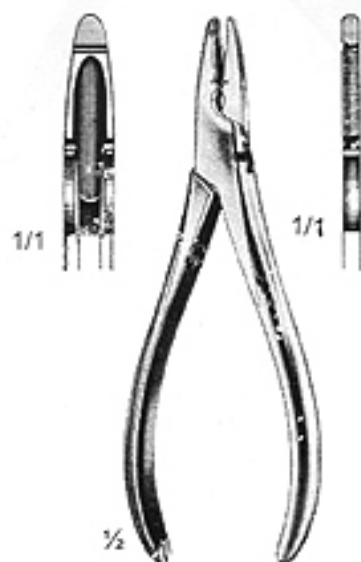

31-073-15
15 cm
Waldsachs

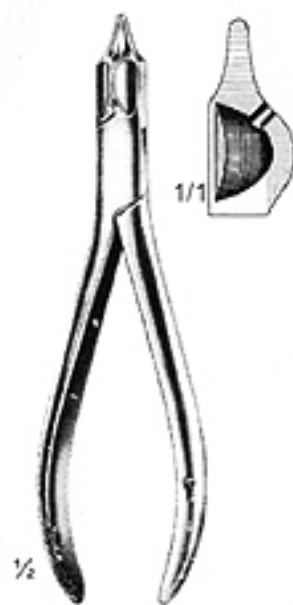

127
31-074-16
16 cm



31-075-16
16 cm



Band Removing
with Plastic Pad
12 cm
31-093-14

No. 141
14 cm
31-092-14

De La Rosa
14 cm
31-091-14



ORTHODONTICS PLIERS
ORTHODONTIE ZANGEN
ALICATES DE ORTODONCIA

31

**TUNGSTEN
CARBIDE
INSERTS**



Ligature Cutter
11.7 cm
31-121-11



Distal Cutter
11.5 cm
31-122-11



Ligature Cutter
11.7 cm
31-123-11



Distal Cutter
11.5 cm
31-124-11

M. A. ARAIN & BROTHERS (PVT.) LTD.

373B



TUNGSTEN CARBIDE INSERTS

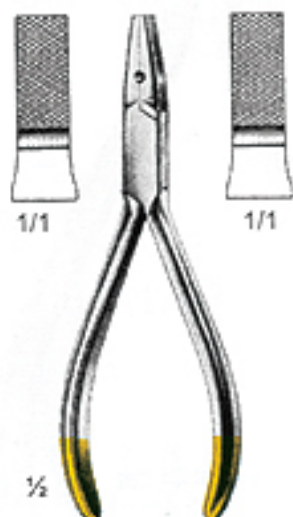

31-125-14
 14 cm

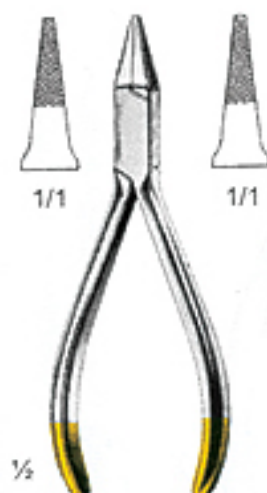

31-126-13
 13.5 cm

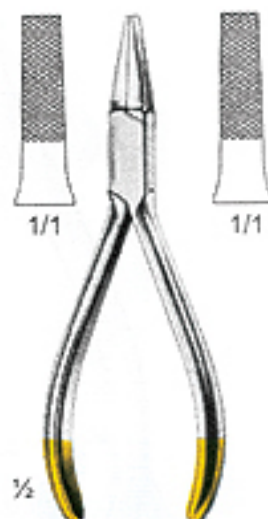

31-127-14
 14 cm



31-128-14
 14 cm

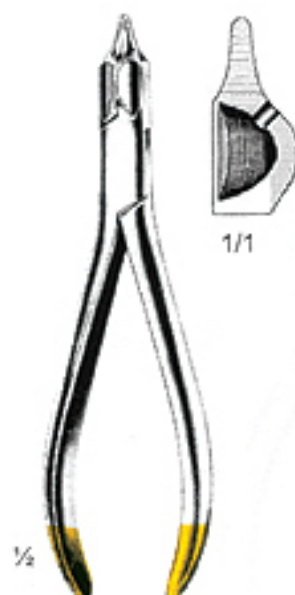

31-129-16
 16 cm
 Universal

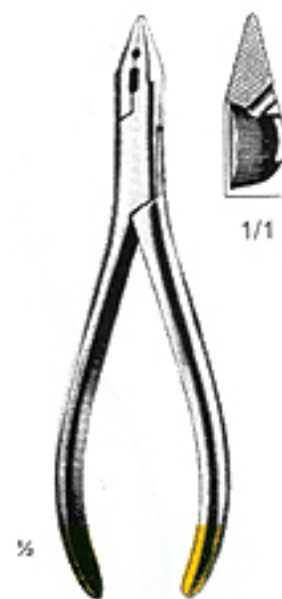

31-130-16
 16 cm
 Universal



ORTHODONTICS PLIERS
 ORTHODONTIE ZANGEN
 ALICATES DE ORTODONCIA



1/2

31-131-12
12.5 cm



31-132-13
13 cm



31-133-13
13 cm



31-134-16
16 cm



31-135-00



31-136-17
17.5 cm



TUNGSTEN
 CARBIDE
 INSERT



31-137-12
12 cm



1/1



Weingart
13 cm
31-140-13

Department

32

SCISSORS
SCHEREN
TIJERAS

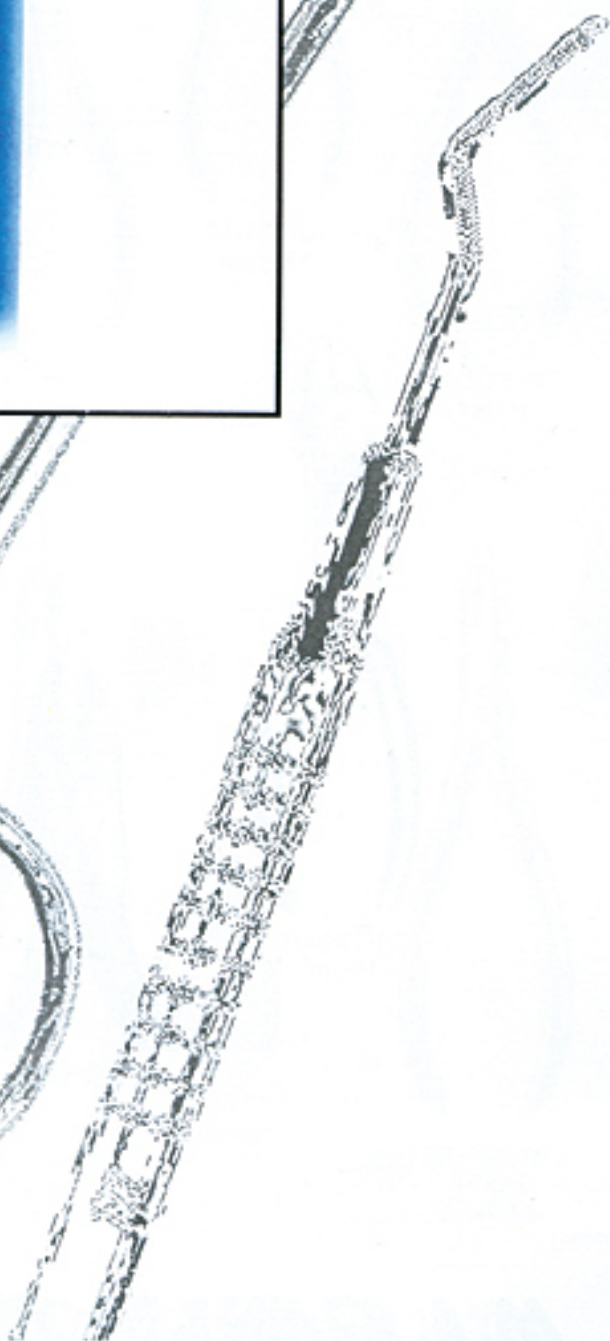
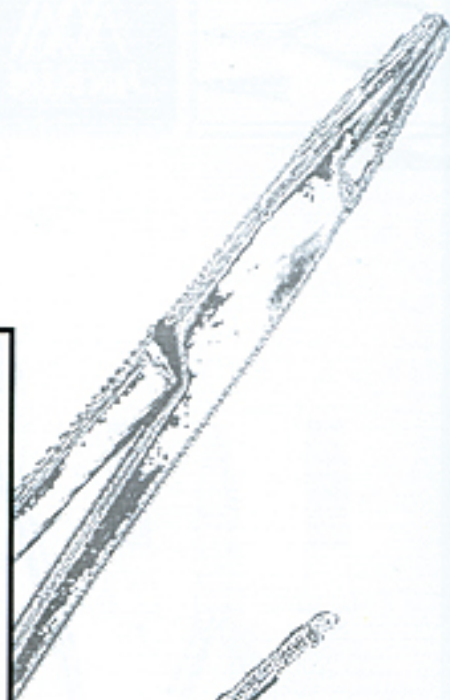
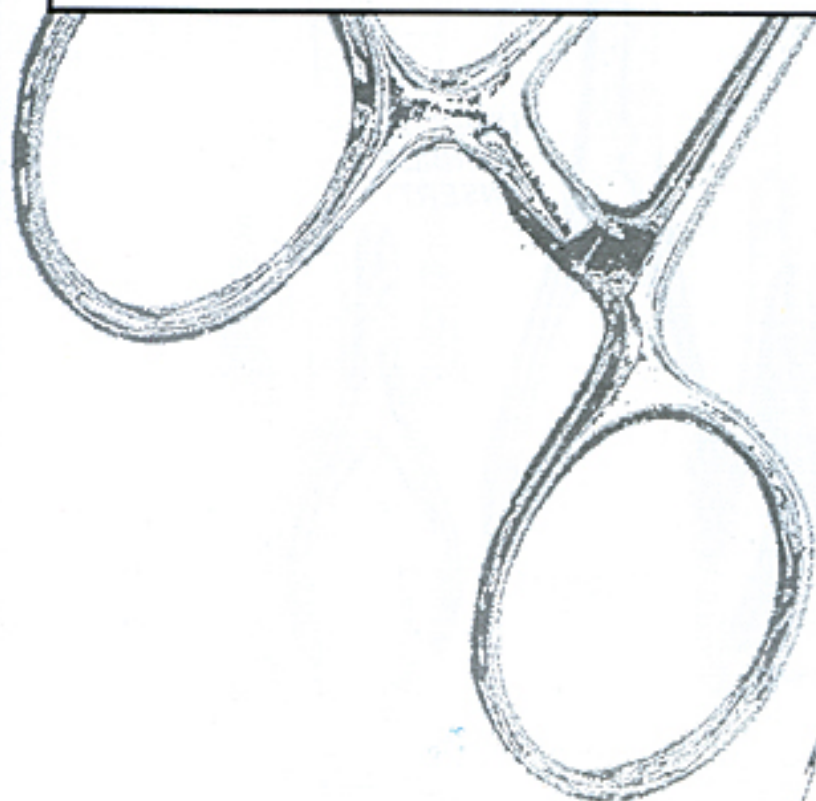

DEPARTMENT NO. 32

FROM
PAGE#

376

TO
PAGE#

382

INSTRUMENTS CATEGORY

SCISSORS
SCHEREN
TIJERAS

CUTICLE SCISSORS, NAIL FILES
 MAGELHAUTSCHEREN, NAGELFEILEN
 TIJERAS PARA UNAS, LIMES A ONGLES

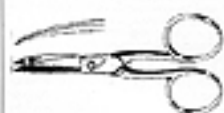
32-001-10
10 cm

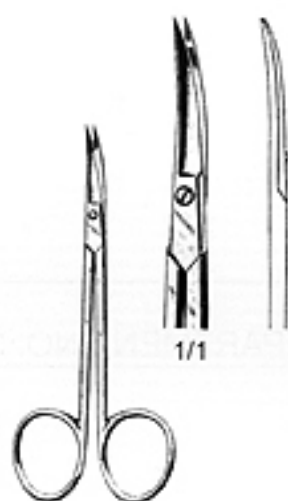

32-002-10
10.5 cm



32-003-10
10 cm



32-001-10
10 cm



32-005-12
12 cm



32-006-11
11 cm



32-007-10
10 cm



ARAIN

NAIL NIPPERS
NAGELZANGEN
PINZAS CORTA-UNAS

32



1/2

32-058-12
12 cm



1/1

32-059-11(11cm)
32-060-13(13cm)
32-061-15(15cm)

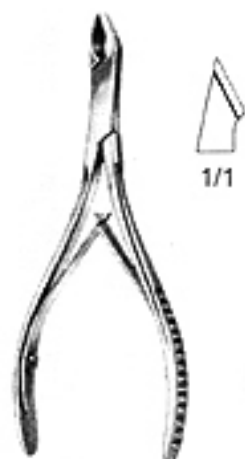

1/1

32-062-11(11cm)
32-063-13(13cm)

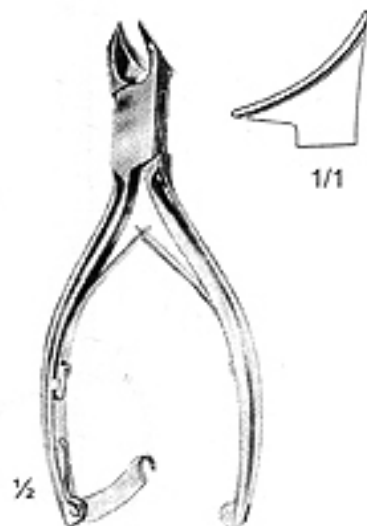

1/1

32-064-14
14 cm



32-065-14(14cm)
32-066-16(16cm)



32-067-11(11cm)
32-068-13(13cm)
Turnbull



1/2

32-069-13
13 cm



32-120-18
18 cm



32-121-20(20 cm)
32-122-25(25 cm)

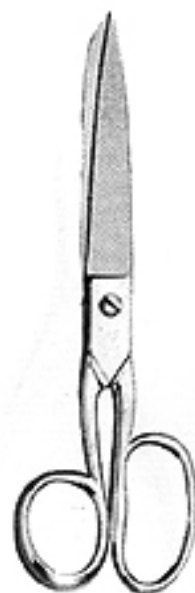

32-123-18
18 cm



32-124-13(13 cm)
32-125-16(16 cm)



32-126-13
13 cm



32-127-11
11.5 cm



ARAIN

SCISSORS
SCHEREN
TIJERAS

32

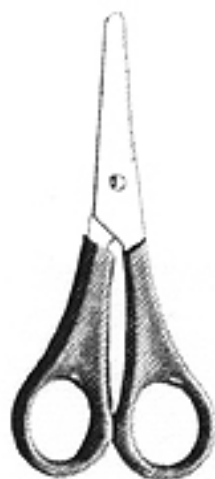

32-128-12
12 cm

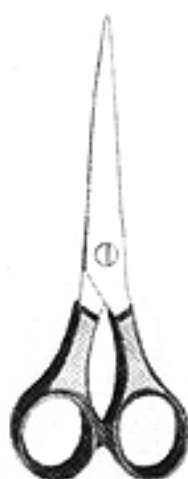

32-129-15
15 cm

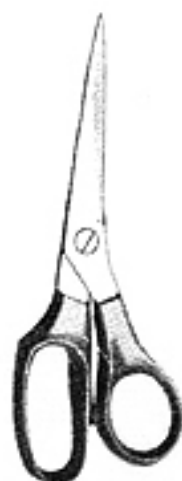

32-130-18
18 cm



32-131-14(14.5 cm)
32-132-18(18 cm)
Lister



32-133-00

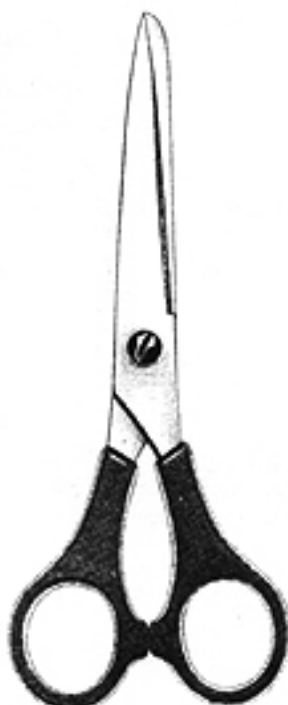

32-134-14
14 cm



32-135-18
18 cm
Universal

M. A. ARAIN & BROTHERS (PVT.) LTD.

381

Certified:

ISO 9001 : 2008

ISO 14001 : 2004

ISO 13485 : 2003

cGMP - FDA (USA)

CE 0120



M.A. ARAIN & BROTHERS

Mailing Address:

P.O. Box: 432, Sialkot-Pakistan

Factory:

Wazirabad Road, Sialkot-Pakistan.

Phone: +92 52 4264926 & 4264571

Fax: +92 52 4264759 & 4264026

E-mail: info@maarain.com

URL: www.maarain.com